



Kuriyama Hydraulic

Connections™

A complete line of hydraulic hose, fittings & crimpers.

ALFAGOMMA®



PIRANHAFLEX™ HYDRAULICS



KuriCrimp™ POWERED BY op



ARGUS



Kuriyama of America, Inc.



EDITION 1020

HOSES
ONE-PIECE B SERIES
ONE-PIECE D SERIES
ONE-PIECE F & P SERIES
TWO-PIECE FERRULES (A & PFR SERIES)
TWO-PIECE INSERTS (A SERIES)
TWO-PIECE INTERLOCK FERRULES & INSERTS (X & Z SERIES)
QUICK RELEASE
ASSEMBLY EQUIPMENT
TECHNICAL INFORMATION

Technical Information:

Assembly Length	300 - 301	Hydraulic Hose Sizing Nomogram.....	297
Cautionary Statement & Limited Warranty	323	Installation & Assembly	302 - 303
Conversion Charts	319 - 320	Kuriyama Warehouse Locations.....	Back Cover
Crimping Equipment.....	272 - 291	Main Plants Overview – Alfagomma.....	9
Establishing a Legacy	6	Providing Excellence and Reliability – Alfagomma.....	8
Fitting Identification / Thread Type	304 - 316	Providing Excellence and Reliability – Piranhaflex	10
Hex Dimensions	321	Pressure Drop International Chart	299
Hose Innovations	21, 22, 28, 36, 42	Pressure Drop U.S. Chart.....	298
Hose Selection Guide.....	13 - 20	Safety Guide.....	294 - 296
Hose User Notes	7	Torque Data.....	317 - 318

Hydraulic Hoses:

ABT2K Alfabiotech 2000 MINETUFF	29	PF528/PF528NC Piranhaflex™ 100R8	56
ABT3K Alfabiotech 3000 MINETUFF	30	PF628/PF628NC Piranhaflex™ 100R8	55
ABT4K Alfabiotech 4000 MINETUFF	31	PF628TL/PF628NCTL Piranhaflex™ Twin Line.....	58
ABT5K Alfabiotech 5000 MINETUFF	32	PFAN388NC Piranhaflex™ 100R7	53
ABT5KST Alfabiotech 5000 SUPERTUFF.....	39	PFLT364 Piranhaflex™ 100R7	54
ABT6K Alfabiotech 6000 MINETUFF	34	PFP354 Piranhaflex™ PLUS 100R7	49
ABT6KST Alfabiotech 6000 SUPERTUFF	40	PFP354NC Piranhaflex™ PLUS 100R7	50
ABTP5K Alfabiotech 5500 Plus MINETUFF	33	Piranha Custom Twin Line.....	59
AF3B Alfaforest MINETUFF.....	27	T1SNTT Temp Tech 1SN/R1AT	43
AT3KMT Alfatech 3000 MINETUFF.....	26	T2SNTT Temp Tech 2SN/R2AT	44
AT3KST Alfatech 3000 SUPERTUFF.....	37	TAJ3BK/TAJ3BU Alfajet 210	67
AT10KOC Oilwell Cementing SUPERTUFF	71	TAJ5BK/TAJ5BU Alfajet 400.....	68
Alfabiotech Hoses.....	28	Temp Tech Hoses.....	42
Alfatech SUPERTUFF Hoses.....	36	TF2MT 2SC/R16 MINETUFF	25
Braid-Lock™ 300 PSI Push-On Hose.....	62	TF2ST 2SC/R16 SUPERTUFF.....	38
Flexor Rig MINETUFF Rotary.....	69	TF2LT 2SC/R16 Low Temp	66
MINETUFF Cover	21-22	TR14TB R14-PTFE SS Braid.....	65
PF151R3 Piranhaflex™ 100R3	46	TR1MT 1SN/R1AT MINETUFF	23
PF267/PF267NC Piranhaflex™ 100R7	52	TR2MT 2SN/R2AT MINETUFF.....	24
PF321TC Piranhaflex™ “Specialty”	60	TR4XF R4 Extra-Flexible 100R4.....	63
PF344LMT Piranhaflex™ “Specialty”	61	TR5 R5 One Wire Braid	64
PF354/PF354NC Piranhaflex™ 100R7	48	TR5TT Temp Tech R5 One Wire Braid.....	45
PF354TL/PF354NCTL Piranhaflex™ Twin Line.....	58	WB10 Waterblast MINETUFF	72
PF367/PF367NC Piranhaflex™ 100R7	51	WB15 Waterblast MINETUFF	73
PF415CP Piranhaflex™	47	WB20 Waterblast MINETUFF	74
PF427/PF427NC Piranhaflex™ 100R18	57		

Hydraulic Fittings:

One-Piece AlfaCrimp/Piranhaflex™ Fittings

B Series Fittings One-Piece AlfaCrimp.....	82 - 112
D Series Fittings One-Piece AlfaCrimp.....	114 - 137
F Series Fittings One-Piece AlfaCrimp	138 - 151
P Series Fittings One-Piece Piranhaflex	152
Quick Release Couplings.....	242 - 271

Two-Piece Fittings

A Series Two-Piece - Standard Fittings.....	154 - 219
V Series Two-Piece Fittings	166, 196
X Series Two-Piece - Interlock Fittings.....	220 - 239
Z Series Two-Piece - Interlock Fittings.....	240 - 241

The trademarks used in connection with the Alfagomma product lines contained in this publication are trademarks of Alfa Gomma, S.p.A.

The trademarks used in connection with the Kuriyama product lines contained in this publication are U.S. trademarks of Kuriyama of America, Inc.

Because we continually examine ways to improve our products, we reserve the right to alter specifications or discontinue products without prior notice.



Hose and Fittings Series Index

Hose Series	Page
ABT2K	29
ABT3K	30
ABT4K	31
ABT5K	32
ABT5KST	39
ABT6K	34
ABT6KST	40
ABTP5K	33
AF3B	27
AT10KOC	71
AT3KMT	26
AT3KST	37
FLEXOR-RIG	69
PF151R3	46
PF267/PF267NC	52
PF321TC	60
PF344LMT	61
PF354/PF354NC	48
PF354NCTL	58
PF354TL	58
PF367/PF367NC	51
PF415CP	47
PF427/PF427NC	57
PF528/PF528NC	56
PF628/PF628NC	55
PF628NCTL	58
PF628TL	58
PFAN388NC	53
PFLT364	54
PPF354	49
PPF354NC	50
T1SNNT	43
T2SNNT	44
TAJ3BK	67
TAJ3BU	67
TAJ5BK	68
TAJ5BU	68
TF2LT	66
TF2MT	25
TF2ST	38
TR14TB	65
TR1MT	23
TR2MT	24
TR4XF	63
TR5	64
TR5TT	45
WB10	72
WB15	73
WB20	74

Fitting Series	Page
A-XXXX-BBAN	201
A-XXXX-BTTF	198
A-XXXX-C612	191
A-XXXX-C613	192
A-XXXX-C614	192
A-XXXX-C616	193
A-XXXX-C619	193
A-XXXX-C61S	191
A-XXXX-C624	194
A-XXXX-C629	195
A-XXXX-C62S	194
A-XXXX-FAE4	181
A-XXXX-FAE9	181
A-XXXX-FB04	203
A-XXXX-FBC9	204
A-XXXX-FBFS	205
A-XXXX-FB09	204
A-XXXX-FB09	205
A-XXXX-FBP4	203
A-XXXX-FBP9	204
A-XXXX-FBP0	202
A-XXXX-FBPP	202
A-XXXX-FGRT	112
A-XXXX-FGRT	198
A-XXXX-FJ45	182
A-XXXX-FJ9L	185
A-XXXX-FJ9M	184
A-XXXX-FJ9S	183
A-XXXX-FJDH	179
A-XXXX-FJIS	217
A-XXXX-FJSH	178
A-XXXX-FKOS	218
A-XXXX-FM4H	209
A-XXXX-FM4L	207
A-XXXX-FM6S	210
A-XXXX-FM9H	210
A-XXXX-FM9L	208
A-XXXX-FMFS	217
A-XXXX-FM0H	209
A-XXXX-FM0L	207
A-XXXX-FNPR	174
A-XXXX-FO45	187
A-XXXX-FO9L	190
A-XXXX-FO9M	189
A-XXXX-FO9S	188
A-XXXX-FOFS	186
A-XXXX-FOFS	187
A-XXXX-FPMS	174
A-XXXX-FPWS	219

Fitting Series	Page
A-XXXX-FSAE	180
A-XXXX-HMEN	196
A-XXXX-KF45	219
A-XXXX-KF90	219
A-XXXX-KFLS	218
A-XXXX-MBAN	211
A-XXXX-MBFS	200
A-XXXX-MBPP	199
A-XXXX-MBPT	200
A-XXXX-MBS9	175
A-XXXX-MJIC	177
A-XXXX-MMFR	216
A-XXXX-MMSH	208
A-XXXX-MMSL	206
A-XXXX-MNPS	173
A-XXXX-MNPT	172
A-XXXX-MOBS	175
A-XXXX-MOFS	186
A-XXXX-MORB	176
A-XXXX-MPS9	173
A-XXXX-MSAE	180
A-XXXX-MSP4	213
A-XXXX-MSP9	213
A-XXXX-MSP9	214
A-XXXX-MSPS	212
AF1-XX	163
AF2-XX	163
AF4-XX	163
AFT-XX	164
AFX-XX	164
AS4-XX	166
B-XXXX-BTTF	88
B-XXXX-C614	101
B-XXXX-C619	102
B-XXXX-C61S	101
B-XXXX-C624	103
B-XXXX-C629	103
B-XXXX-C62S	102
B-XXXX-FBC9	106
B-XXXX-FBFS	105
B-XXXX-FB04	106
B-XXXX-FB09	107
B-XXXX-FBP0	105
B-XXXX-FGRT	112
B-XXXX-FJ45	92
B-XXXX-FJ9L	95
B-XXXX-FJ9M	94
B-XXXX-FJ9S	93
B-XXXX-FJDH	91

Fitting Series	Page
B-XXXX-FJIS	112
B-XXXX-FJSH	90
B-XXXX-FKOS	112
B-XXXX-FM4H	111
B-XXXX-FM4L	109
B-XXXX-FM9H	111
B-XXXX-FM9L	109
B-XXXX-FM0H	110
B-XXXX-FM0L	108
B-XXXX-FNPR	86
B-XXXX-FO45	98
B-XXXX-FO9L	100
B-XXXX-FO9M	100
B-XXXX-FO9S	99
B-XXXX-FOFS	97
B-XXXX-FPMS	86
B-XXXX-FSAE	95
B-XXXX-HMEN	84
B-XXXX-MBPP	104
B-XXXX-MBPT	104
B-XXXX-MBS9	88
B-XXXX-MJIC	89
B-XXXX-MMSH	110
B-XXXX-MMSL	108
B-XXXX-MNPS	85
B-XXXX-MNPT	84
B-XXXX-MOBS	87
B-XXXX-MOFS	96
B-XXXX-MORB	87
B-XXXX-MPS9	85
B-XXXX-MSPS	107
BBOLT-XX	201
BL-XXBK	62
BL-XXBU	62
BL-XXGR	62
BL-XXGY	62
BL-XXRD	62
BL-XXUL	62
C61SF-XX	195
C62SF-XX	198

Because we continually examine ways to improve our products, we reserve the right to alter specifications or discontinue products without prior notice.



HOSES

ONE-PIECE B SERIES

ONE-PIECE D SERIES

ONE-PIECE F & P SERIES

TWO-PIECE FERRULES (A & PFR SERIES)

TWO-PIECE INSERTS (A-SERIES)

TWO-PIECE INTERLOCK FERRULES & INSERTS (X & Z-SERIES)

QUICK RELEASE

ASSEMBLY EQUIPMENT

TECHNICAL INFORMATION

Hose and Fittings Series Index

HOSES
ONE-PIECE B SERIES
ONE-PIECE D SERIES
ONE-PIECE F & P SERIES
TWO-PIECE FERRULES (A & PFR SERIES)
TWO-PIECE INSERTS (A SERIES)
TWO-PIECE INTERLOCK FERRULES & INSERTS (X & Z SERIES)
QUICK RELEASE
ASSEMBLY EQUIPMENT
TECHNICAL INFORMATION

Fitting Series	Page
D-XXXX-C612	126
D-XXXX-C613	126
D-XXXX-C614	127
D-XXXX-C616	127
D-XXXX-C619	128
D-XXXX-C61S	125
D-XXXX-C624	129
D-XXXX-C629	129
D-XXXX-C62S	128
D-XXXX-FB04	132
D-XXXX-FB09	133
D-XXXX-FBPO	131
D-XXXX-FJ45	120
D-XXXX-FJ9L	122
D-XXXX-FJ9M	121
D-XXXX-FJ9S	121
D-XXXX-FJDH	119
D-XXXX-FJDH	120
D-XXXX-FM4H	137
D-XXXX-FM4L	135
D-XXXX-FM9H	137
D-XXXX-FM9L	135
D-XXXX-FMOH	136
D-XXXX-FMOL	134
D-XXXX-FNPR	117
D-XXXX-FO45	123
D-XXXX-FO9L	125
D-XXXX-FO9M	124
D-XXXX-FO9S	124
D-XXXX-FOFS	123
D-XXXX-FPMS	117
D-XXXX-FSAE	118
D-XXXX-MAPI	116
D-XXXX-MBPP	130
D-XXXX-MBPT	130
D-XXXX-MJIC	119
D-XXXX-MMSH	136
D-XXXX-MMSL	134
D-XXXX-MNPS	116
D-XXXX-MNPT	116
D-XXXX-MOFS	122
D-XXXX-MORB	118
F-XXXX-C61S	142
F-XXXX-C614	142
F-XXXX-C619	143

Fitting Series	Page
F-XXXX-C624	144
F-XXXX-C629	144
F-XXXX-C62S	143
F-XXXX-CFL2	145
F-XXXX-CFL3	146
F-XXXX-CFL4	146
F-XXXX-CFL6	147
F-XXXX-CFL7	147
F-XXXX-CFL9	148
F-XXXX-CFLS	145
F-XXXX-FHUN	150
F-XXXX-FJ45	140
F-XXXX-FJ9M	140
F-XXXX-FJDH	139
F-XXXX-FM9H	149
F-XXXX-FMOH	148
F-XXXX-FO45	141
F-XXXX-FO9M	141
F-XXXX-FOFS	141
F-XXXX-MAPI	149
F-XXXX-MHUN	150
F-XXXX-MJIC	139
F-XXXX-MMSH	148
F-XXXX-MNPT	139
F-XXXX-NPT2	151

Fitting Series	Page
MBOLT-XX	209
MBS-XX-H	214
MBS-XX-LH	213
MTN-XX-L	212
MTN-XX-H	213
P-XXXX-FJDH-SS	152
P-XXXX-MNPT-SS	152
P-XXXX-MORB-SS	152
PFR-XX	165
PFR3-XX	165
PFR7-XX	165
V-XXXX-MAPI	196
VS4-XX	166
X-XXXX-C614	231
X-XXXX-C619	232
X-XXXX-C61S	231
X-XXXX-C624	233
X-XXXX-C629	233
X-XXXX-C62S	232
X-XXXX-CFL4	234
X-XXXX-CFL9	235
X-XXXX-CFLS	234
X-XXXX-FB04	237
X-XXXX-FB09	237
X-XXXX-FBPO	236
X-XXXX-FHUN	235
X-XXXX-FJ45	229
X-XXXX-FJ9M	229
X-XXXX-FJSH	229
X-XXXX-FM4H	239
X-XXXX-FM9H	239
X-XXXX-FMOH	238
X-XXXX-FO45	230
X-XXXX-FO9M	230
X-XXXX-FOFS	230
X-XXXX-MBPP	236
X-XXXX-MBPT	236
X-XXXX-MHUN	235
X-XXXX-MJIC	228
X-XXXX-MMSH	238
X-XXXX-MNPT	228
XF1-XX	227
XF2-XX	227
Z-XXXX-C624	240
Z-XXXX-C629	240
Z-XXXX-C62S	240
Z-XXXX-FHUN	241
Z-XXXX-MAPI	241
Z-XXXX-MHUN	241
ZF1-XX	227

Quick Release Fitting Series	Page
QAC-XX	249
QAF-XXXX-FNPR	249
QAM-XXXX-FNPR	249
QAP-XX	249
QBC-XX	251
QBF-XXXX-FNPR	251
QBM-XXXX-FNPR	251
QBP-XX	251
QCF-XXXX-FNPR	257
QCF-XXXX-FORB	257
QCM-XXXX-FORB	257
QFC-XX	261
QFF-XXXX-FNPR	259
QFF-XXXX-FORB	259
QFM-XXXX-FNPR	259
QFM-XXXX-FORB	259
QFP-XX	261
QG-XXXX-FNPR	261
QKF-XXXX-FNPR	265
QKM-XXXX-FNPR	265
QPF-XXXX-FNPR	253
QPM-XXXX-FNPR	253
QSF-XXXX-FNPR	263
QSM-XXXX-FNPR	263
QTC-XX	255
QTF-XXXX-FNPR	255
QTM-XXXX-FNPR	255
QTP-XX	255
QXC-XX	267
QXF-XXXX-MNPT	267
QXM-XXXX-FNPR	267
QXP-XX	267

Because we continually examine ways to improve our products, we reserve the right to alter specifications or discontinue products without prior notice.

Crimpers & Accessories by Series/Part Number	Page
CALKIT-H135	281
CALKIT-H135	283
CALKIT-H144/170	282
DIEBASE-H69	278
DIEBASE-H69	279
DIEBASE-H119	281
DIEBASE-H119	282
DIEBASE-H119	283
DIEBASE-HS54	280
DIERACK-H69	278
DIERACK-H69	279
DIERACK-H119	281
DIERACK-H119	282
DIERACK-H119	283
DIERACK-HS54	280
ES3	285
ES3-MULTI	285
ES3-PRESS	285
ES3-QUAL	285
ES3-USB	285
H119	281
H119	282
H119	283
H144	282
H39	274
H39	275
H39	276
H69	278
H69	279
HS54	280
HTG1100	291
HTS1100	291
KC1-H135	281
KC1-H135-230/1	281
KC1-H135-230/3	281
KC1-H47E	274
KC1-H47E-BASE	274
KC1-H47E-HP	274
KC1-H47E-PAP	274
KC1-H47PI	276
KC1-H47PM	275
KC1-H83	278
KC1-H83-230/1	278
KC1-H83-230/3	278
KC3-H135	283
KC3-H135-230/3	283
KC3-H170	282
KC3-H170-230/3	282

Crimpers & Accessories by Series/Part Number	Page
KC3-H88	279
KC3-H88-230/1	279
KC3-H88-230/3	279
KC3-HS54	280
KC3-HS54-230/3	280
KCDCT-H39	274
KCDCT-H39	275
KCDCT-H39	276
KCDH119-XX	284
KCDH144-XX	284
KCDH39-XX	274
KCDH39-XX	275
KCDH39-XX	276
KCDH69-XX	278
KCDH69-XX	279
KCDHS54-XX	280
KCPQCT-H135/144	281
KCPQCT-H135/144	282
KCPQCT-H135/144	283
KCPQCT-H69	278
KCPQCT-H69	279
KCPQCT-HS83	280
KCQCT-H69	278
KCQCT-H69	279
KCQCT-H119	281
KCQCT-H119	282
KCQCT-H119	283
KCQCT-HS54	280
KCS-TF1/E-110/1	286
KCS-TF2/E-230/1	287
KCS-TF3/E-230/1	287
KD100-XX	277
KD165	277
KD165-124RK	277
KSKIVE1	288
KSKIVE2	288
MIRROR-H170	282
NS	290
PCG	290
PEDAL-ES	279
PEDAL-ES	280
PEDAL-ES	282
PEDAL-ES	283
PEDAL-KC1	278
PEDAL-KC1	281
R1S0033	289
R1S0055	289
R1S1017	289

Because we continually examine ways to improve our products, we reserve the right to alter specifications or discontinue products without prior notice.

HOSES
ONE-PIECE B SERIES
ONE-PIECE D SERIES
ONE-PIECE F & P SERIES
TWO-PIECE FERRULES (A & PFR SERIES)
TWO-PIECE INSERTS (A SERIES)
TWO-PIECE INTERLOCK FERRULES & INSERTS (X & Z SERIES)
QUICK RELEASE
ASSEMBLY EQUIPMENT
TECHNICAL INFORMATION

Establishing a Legacy



HOSES
ONE-PIECE B SERIES
ONE-PIECE D SERIES
ONE-PIECE F & P SERIES
TWO-PIECE FERRULES (A & PFR SERIES)
TWO-PIECE INSERTS (A SERIES)
TWO-PIECE INTERLOCK FERRULES & INSERTS (X & Z SERIES)
QUICK RELEASE
ASSEMBLY EQUIPMENT
TECHNICAL INFORMATION

DESIGN

Throughout the world, the name ALFAGOMMA has become synonymous with quality, a reputation based on first class products, a commitment to research and development and ongoing capital investment.

ALFAGOMMA's development and product engineering staff continues to provide fluid conveying product innovations that assure better performance and cost savings for customers.

ALFAGOMMA hose and couplings are designed to work together as a system for problem free performance, no matter what machine you operate. The performance of all ALFAGOMMA products exceeds SAE, DIN, and JIS requirements and some hoses meet the MSHA and LOBA flame resistance requirement, as well.

LEADERSHIP IN HYDRAULIC HOSE AND COUPLING COMPONENTS

ALFAGOMMA has become a world-leading manufacturer of fluid power and fluid system components. A positive attitude toward the demands from new equipment, using the latest technology, has allowed ALFAGOMMA to introduce many outstanding new hydraulic hose types. These hoses have found acceptance in a wide range of industries. Some examples are:

Mining	Earthmoving	Molding
Logging	Agriculture	Drilling
Petroleum	Waste/Refuse	Crane
Railroad	Manufacturing	
Construction	Pulp and Plywood Mills	

OUR COMMITMENT

By remaining alert to customer's needs, ALFAGOMMA is constantly engineering new products for tomorrow's markets as well as modifying them for even higher performances. ALFAGOMMA's commitment to innovation and service makes the company's products known throughout the world for quality, reliability and leadership. When you need quality hose and couplings, use the best available. Now you can count on ALFAGOMMA for all your needs.

TESTING

ALFAGOMMA's laboratories are fully equipped to carry out tests according to international standards like SAE, DIN and JIS. New products are also subjected to laboratory simulation of actual service prior to being released on the market.

WORLD CLASS QUALITY

ALFAGOMMA is working to comply with internationally recognized quality programs requiring stringent standards. Many of our customers are demanding ISO qualification or its equivalent as a prerequisite for purchasing. This standard is an assurance of consistent quality. For ALFAGOMMA this is just the start of "doing it right from the beginning."

WARRANTY INFORMATION

ALFAGOMMA hose and fittings are designed, engineered and tested to be used together in an assembly.

The use of ALFAGOMMA fittings on other manufacturer's hose or the use of ALFAGOMMA hose with other manufacturer's fittings may result in the production of unreliable or unsafe assemblies. It is neither recommended nor authorized by ALFAGOMMA.

ALFAGOMMA recommends only those hose and coupling combinations specified in the ALFAGOMMA Hydraulic Products Catalogs.

ALFAGOMMA disclaims any liability for any hose assemblies that have not been produced in conformance with ALFAGOMMA assembly recommendations and current crimp data charts.

Extensive impulse testing has been performed by ALFAGOMMA to verify the recommendations contained in this catalogue. A simple burst or pressure test cannot determine a hose and coupling combination.

Any claim for defects must be made in writing on the appropriate ISO9000 complaint form within 8 days from receipt of the product. ALFAGOMMA will have a reasonable opportunity thereafter to examine and investigate the alleged defect.

The customer's exclusive remedy with respect to any claim of any kind whatsoever shall be refund of the purchase price or replacement of the product at the option of ALFAGOMMA and in no event shall ALFAGOMMA be liable for any incidental or consequential damages whatsoever.

Because we continually examine ways to improve our products, we reserve the right to alter specifications or discontinue products without prior notice.



IMPORTANT NOTE FOR USERS OF ALFAGOMMA AND PIRANHAFLEX HYDRAULIC HOSES

Hose assemblies require caution in use not only to ensure that they provide long service life but also to guard against potentially dangerous failure. Serious injury, death and destruction of property can result from the rupture or blowing-apart of a hydraulic hose assembly that is damaged, worn out, badly assembled or installed incorrectly.

Users should follow good maintenance practices. Avoid expensive downtime by establishing a program of inspection, testing and replacement of hose assemblies before failure occurs; taking into account such factors as severity of application, frequency of equipment use, and past performance of hose assemblies. Document your maintenance, inspections and testing.

Only properly trained persons should inspect, test or service hose assemblies and this training should be updated regularly.

Users should carefully observe the precautions listed below (under “Be aware that . . .”) and they should also closely follow our suggestions for the proper selection of hose and couplings. In addition, care should be taken not to exceed the minimum bend radius listed for each hose size and type. Maximum operating pressure should not exceed the pressures listed. Instructions for assembling fittings to different hoses should be followed carefully to ensure the safe performance of the complete assembly.

By following the recommendations on hose assembly routing and installation, improved safety and longer service life of any hose installation will result.

Hydraulic fluid under pressure can be potentially dangerous! An explosive burst or stream of escaping fluid can cause damage to equipment as well as serious injury to persons nearby.

Be aware that . . .

1. Highly pressurized fluid escaping from a small pinhole can be almost invisible, and yet exert extreme force capable of penetrating the skin and other body tissues, causing possible severe injury.
2. Hot fluids or chemicals can cause severe burns.
3. Pressurized fluids, if released uncontrolled, can exert a tremendous explosive force.
4. All rubber hydraulic hoses listed in this catalog are electrically conductive.
5. Some hydraulic fluids are highly flammable.

and . . .

6. Always position a shield between you and any pressurized hydraulic lines when working next to them, or, better yet, release the pressure in the lines.
7. Wear safety glasses.
8. Do not use your hands to check for leaks. Instead, use a piece of cardboard. Do not touch a pressurized hydraulic hose assembly with any part of your body, if fluid punctures the skin, even if no pain is felt, a serious emergency exists. Obtain medical assistance immediately. Failure to do so can result in loss of the injured body part or death.
9. Stay out of hazardous areas while testing hose assemblies under pressure. Use proper safety protection.
10. If an injury or reaction occurs, get medical attention immediately.
11. Use only non-conductive thermoplastic hoses where electrical conductivity is not desired, for example for use with equipment working near electrical power lines.

Because we continually examine ways to improve our products, we reserve the right to alter specifications or discontinue products without prior notice.

Providing Excellence and Reliability



ALFAGOMMA

Developing cutting-edge technology and innovative solutions. Supplying top quality products worldwide. These are the pillars on which ALFAGOMMA's success has been built since 1956. Today, ALFAGOMMA plays a leading role in the industrial and hydraulic rubber hoses segment, with 22 plants, 86 subsidiaries and assembly plants and a worldwide presence spread across 22 countries.

The Group has been providing top quality products for 60 years and it has always been known for its excellent technical department: a strong commitment to quality and control design that is reflected in the Group's state-of-the-art product portfolio, which also include adapters and swivel connectors.



MANUFACTURING PLANTS

22

IN 10 COUNTRIES

- ITALY – FINLAND
- FRANCE – GERMANY
- SWEDEN – UK
- USA – BRAZIL
- CHINA – MALAYSIA



SUBSIDIARIES AND ASSEMBLY PLANTS

86

IN 22 COUNTRIES AND 5 CONTINENTS



QUALITY CERTIFICATION

ISO

ISO 9001 SINCE 1993
ISO 14001 SINCE 1999



EMPLOYEES

3,800

AROUND THE WORLD

Because we continually examine ways to improve our products, we reserve the right to alter specifications or discontinue products without prior notice.



HOSES
ONE-PIECE B SERIES
ONE-PIECE D SERIES
ONE-PIECE F & P SERIES
TWO-PIECE FERRULES (A & PFR SERIES)
TWO-PIECE INSERTS (A SERIES)
TWO-PIECE INTERLOCK FERRULES & INSERTS (X & Z SERIES)
QUICK RELEASE
ASSEMBLY EQUIPMENT
TECHNICAL INFORMATION

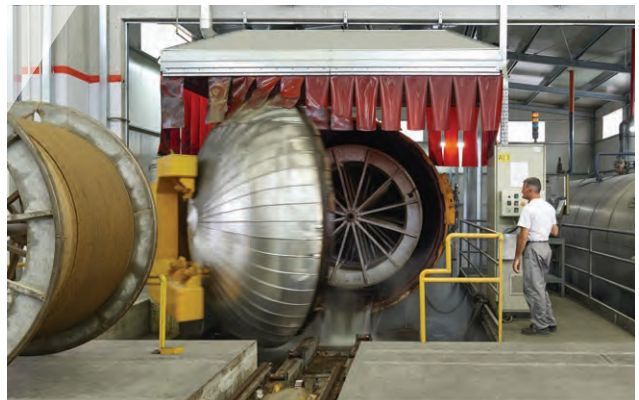

HOSES

ONE-PIECE
B SERIES

ONE-PIECE
D SERIES

ONE-PIECE
F & P SERIES

TWO-PIECE FERRULES
(A & PFR SERIES)

TWO-PIECE INSERTS
(A SERIES)

TWO-PIECE INTERLOCK
FERRULES & INSERTS
(X & Z SERIES)

QUICK
RELEASE

ASSEMBLY
EQUIPMENT

TECHNICAL
INFORMATION

Because we continually examine ways to improve our products, we reserve the right to alter specifications or discontinue products without prior notice.

Providing Excellence and Reliability



About (Piranha®) Piranhaflex™ Thermoplastic Hydraulic Hose & Fittings

Piranhaflex™ Thermoplastic Hydraulic hoses were first available to the Kuriyama Distribution Network in 2009, but the “DNA” of the Piranha® brand goes back to their original patent on braid reinforced high pressure thermoplastic hoses.

Since that time, they have continued to add additional new products to their quality line-up of hydraulic hoses to meet your application needs.

These include:

100R7 HOSES

- Piranhaflex™ PF354 and PF354NC Series (for non-conductive applications) for medium pressure hydraulic hose applications for hydraulic oil and lubrication lines. ANSI 92.2 compliant in -02, -03, -04, -05, -06 and -08 sizes.
- Piranhaflex™ Plus PFP354 and PFP354NC Series (for non-conductive applications) for medium pressure hydraulic lines commonly used on fork trucks and utility equipment featuring a low coefficient of friction cover.
- Piranhaflex™ PF267 and PF267NC Series (for nonconductive applications) for medium pressure hydraulic hose applications for hydraulic oil and lubrication lines. Featuring improved kink resistance, up to 53% more force required to reach kink initiation versus competitive 100R7 type hose styles. In addition, improved flexural rigidity, up to 16% less force to bend versus competitive 100R7 type hoses. ANSI 92.2 compliant in -02, -03, -04, -05, -06 and -08 sizes.

100R8 HOSES

- Piranhaflex™ PF628 and PF628NC Series (for non-conductive applications) for general purpose high pressure hydraulic applications with working pressures of 2,250 to 5,000 psi (depending on size).
- Piranhaflex™ PF528 and PF528NC Series (for non-conductive applications) for general purpose high pressure hydraulic applications with working pressures of 2,250 to 5,000 psi (depending on size). Featuring improved kink resistance, up to 50% more force required to reach kink initiation versus competitive 100R8 type hose styles. In addition, improved flexural rigidity, up to 17% less force to bend versus competitive 100R8 type hoses.

100R18 HOSES

Piranhaflex™ PF427 Series for general purpose high pressure hydraulic applications with a constant working pressure of 3,000 psi.

Because we continually examine ways to improve our products, we reserve the right to alter specifications or discontinue products without prior notice.

HOSES
ONE-PIECE B SERIES
ONE-PIECE D SERIES
ONE-PIECE F & P SERIES
TWO-PIECE FERRULES (A & PFR SERIES)
TWO-PIECE INSERTS (A SERIES)
TWO-PIECE INTERLOCK FERRULES & INSERTS (X & Z SERIES)
QUICK RELEASE
ASSEMBLY EQUIPMENT
TECHNICAL INFORMATION

Hydraulic Hose Index

	ABT2K - Alfabiotech 2000 MINETUFF... 29		Flexor Rig - MINETUFF Rotary..... 69
	ABT3K - Alfabiotech 3000 MINETUFF... 30		PF151R3 - Piranhaflex™ 100R3..... 46
	ABT4K - Alfabiotech 4000 MINETUFF ... 31		PF267/PF267NC - Piranhaflex™ 100R7..... 52
	ABT5K - Alfabiotech 5000 MINETUFF ... 32		PF321TC - Piranhaflex™ “Specialty” 60
	ABT5KST - Alfabiotech 5000 SUPERTUFF..... 39		PF344LMT - Piranhaflex™ “Specialty” 61
	ABT6K - Alfabiotech 6000 MINETUFF ... 34		PF354/PF354NC - Piranhaflex™ 100R7..... 48
	ABT6KST - Alfabiotech 6000 SUPERTUFF..... 40		PF354TL & PF354NCTL - Piranhaflex™ Twin Line 58
	ABTP5K - Alfabiotech 5500 Plus MINETUFF 33		PF367/PF367NC - Piranhaflex™ 100R7.....51
	AF3B - Alfaforest MINETUFF 27		PF427/PF427NC - Piranhaflex™ 100R18..... 57
	AT3KMT - Alfatech 3000 MINETUFF 26		PF415CP - Piranhaflex™47
	AT3KST - Alfatech 3000 SUPERTUFF 37		PF628/PF628NC - Piranhaflex™ 100R8..... 55
	AT10KOC - Oilwell Cementing SUPERTUFF..... 71		PF628TL & PF628NCTL- Piranhaflex™ Twin Line 58
	BRAID-LOCK™ 300 PSI Push-On Hose..... 62		PFAN388NC - Piranhaflex™ 100R7 53
			PFLT364 - Piranhaflex™ 100R7 - Low Temp 54

Because we continually examine ways to improve our products, we reserve the right to alter specifications or discontinue products without prior notice.

HOSES

ONE-PIECE B SERIES

ONE-PIECE D SERIES

ONE-PIECE F & P SERIES

TWO-PIECE FERRULES (A & PFR SERIES)

TWO-PIECE INSERTS (A SERIES)

TWO-PIECE INTERLOCK FERRULES & INSERTS (X & Z SERIES)

QUICK RELEASE

ASSEMBLY EQUIPMENT

TECHNICAL INFORMATION

Hydraulic Hose Index

	PF528/528NC - Piranhaflex™ 100R8 56		TR2MT - 2SN/R2AT MINETUFF 24
	PFP354 - Piranhaflex™ PLUS 100R7..... 49		TR4XF - R4 Xtra-Flexible 100R4..... 63
	PFP354NC - Piranhaflex™ PLUS 100R7..... 50		TR5 - R5 One Wire Braid 64
	Piranha® Custom Twin Line 59		TR5TT - Temp Tech One Wire Braid 45
	T1SNTT - Temp Tech 1SN/R1AT..... 43		WB10 - Waterblast MINETUFF 72
	T2SNTT - Temp Tech 2SN/R2AT..... 44		WB15 - Waterblast MINETUFF 73
	TAJ3BK/TAJ3BU - Alfajet 210 Pressure Washer Hose 67		WB20 - Waterblast MINETUFF..... 74
	TAJ5BK/TAJ5BU - Alfajet 400 Pressure Washer Hose 68		
	TF2LT - 2SC/R16 LT Low Temp..... 66		
	TF2MT - 2SC/R16 MINETUFF 25		
	TF2ST - 2SC/R16 SUPERTUFF 38		
	TR1MT - 1SN/R2AT MINETUFF 23		
	TR14TB - R14 PTFE/Stainless Braid..... 65		

Because we continually examine ways to improve our products, we reserve the right to alter specifications or discontinue products without prior notice.

AGENCY SPECIFICATIONS

The listings below are intended only as guides in identifying which ALFAGOMMA or Piranhaflex hoses comply with requirements of various agencies.

SAE – Society of Automotive Engineers
DIN – Deutsche Institute Normen
EN – European Norme
ISO – International Organization for Standardization
DNV – Det Norske Veritas

ABS – American Bureau of Shipping
GIG – Glowny Instytut Gornietwa
GL – Germanischer Lloyd
BV – Bureau Veritas
NKK – Nippon Kaiji Kyokai
RINA – Registro Navale Italiano

MSHA (US) – Mining Safety and Health Administration
USDOT – U.S. Department of Transportation
USCG – U.S. Coast Guard

HOSE TYPE			AGENCY												
Hose Series	Hose Description	Cat. Page	SAE J517	EN	ISO	ALFAGOMMA Proprietary Hose	DNV‡ GL	ABS	BV	NKK	RINA	Lloyd's Register	MSHA	USDOT	USCG
ABT2K	ALFABIOTECH 2000 MINETUFF	29			18572	X							X		
ABT3K	ALFABIOTECH 3000 MINETUFF	30	100R12		18752	X	X					X	X		X
ABT4K	ALFABIOTECH 4000 MINETUFF	31	100R12		18752	X	X	X				X	X		X
ABT5K	ALFABIOTECH 5000 MINETUFF	32	100R13		18752	X	X	X				X	X		X
ABT5KST	ALFABIOTECH 5000 SUPER-TUFF	39	100R13		18752	X	X	X				X	X		X
ABT6K	ALFABIOTECH 6000 MINETUFF	34	100R15		18752	X	X	X	X			X	X		X
ABT6KST	ALFABIOTECH 6000 SUPERTUFF	40	100R15		18752	X	X	X	X			X	X		
ABTP5K	ALFABIOTECH 5500 PLUS MINETUFF	33			18752	X	X	X				X	X		
AF3B	ALFAFOREST MINETUFF	27				X									
AT10KOC	OIL CEMENTING SUPERTUFF	71				X							X		
AT3KMT	ALFATECH 3000 MINETUFF	26	100R17	857	11237	X		X					X		
AT3KST	ALFATECH 3000 SUPERTUFF	37	100R17	857	11237	X		X					X		
FLEXOR RIG	FLEXOR RIG MINETUFF ROTARY	69				X							X		
PF151R3	PIRANHAFLEX 100R3	46													
PF267	PIRANHAFLEX 100R7	52	100R7												
PF267NC	PIRANHAFLEX 100R7	52	100R7												
PF321TC	PIRANHAFLEX SPECIALTY	60													
PF344LMT	PIRANHAFLEX SPECIALTY	61													
PF354	PIRANHAFLEX 100R7	48	100R7												
PF354TL	PIRANHAFLEX 100R7	58													
PF354NC	PIRANHAFLEX 100R7	48	100R7												
PF354NCTL	PIRANHAFLEX 100R7	58													
PF367	PIRANHAFLEX 100R7	51	100R7												
PF367NC	PIRANHAFLEX 100R7	51	100R7												
PF415CP	PIRANHAFLEX	47													
PF427	PIRANHAFLEX 100R18	57	100R18												
PF427NC	PIRANHAFLEX 100R18	57	100R18												
PF528	PIRANHAFLEX 100R8	56	100R8												
PF528NC	PIRANHAFLEX 100R8	56	100R8												
PF628	PIRANHAFLEX 100R8	55	100R8												
PF628TL	PIRANHAFLEX 100R8	58													
PF628NC	PIRANHAFLEX 100R8	55	100R8												
PF628NCTL	PIRANHAFLEX 100R8	58													
PFAN388NC	PIRANHAFLEX 100R7	53	100R7												

‡ Det Norske Veritas (DNV) approvals are with permanent (crimp) type fittings only

¶ Hose with MSHA (Mine Safety and Health Administration) approved cover will be accordingly on the layline

Listing may vary by hose style and size, for current and complete information, contact ALFAGOMMA or Piranhaflex for details.

* DOT Type All approval up to size -12

Because we continually examine ways to improve our products, we reserve the right to alter specifications or discontinue products without prior notice.

Hose Selection Guide



AGENCY SPECIFICATIONS

The listings below are intended only as guides in identifying which ALFAGOMMA or Piranhaflex hoses comply with requirements of various agencies.

SAE – Society of Automotive Engineers
DIN – Deutsche Institute Normen
EN – European Norme
ISO – International Organization for Standardization
DNV – Det Norske Veritas

ABS – American Bureau of Shipping
GIG – Główny Instytut Gornietwa
GL – Germanischer Lloyd
BV – Bureau Veritas
NKK – Nippon Kaiji Kyokai
RINA – Registro Navale Italiano

MSHA (US) – Mining Safety and Health Administration
USDOT – U.S. Department of Transportation
USCG – U.S. Coast Guard

HOSE TYPE			AGENCY												
Hose Series	Hose Description	Cat. Page	SAE J517	EN	ISO	ALFAGOMMA Proprietary Hose	DNV‡ GL	ABS	BV	NKK	RINA	Lloyd's Register	MSHA	USDOT	USCG
PFLT364	PIRANHAFLEX 100R7	54	100R7												
PFP354	PIRANHAFLEX 100R7	49	100R7												
PFP354NC	PIRANHAFLEX 100R7	50	100R7												
T1SNTT	TEMP TECH 1SN	43	100R1AT	853 1SN	1436	X	X								X
T2SNTT	TEMP TECH 2SN	44	100R2AT	853 2SN	1436	X									
TAJ3BK	ALFAJET 210	67				X									
TAJ3BU	ALFAJET 210	67				X									
TAJ5BK	ALFAJET 400	68				X									
TAJ5BU	ALFAJET 400	68				X									
TF2LT	2SC/R16 LOW TEMP	66	100R16	857 2SC	11237		X				X				
TF2MT	2SC/R16 MINETUFF	25	100R16	857 2SC	11237		X				X		X		X
TF2ST	2SC/R16 SUPERTUFF	38											X		
TR14TB	R14 PTFE SS BRAID	65	100R14												
TR1MT	1SN/R1AT MINETUFF	23	100R1AT	853 1SN	1436		X	X					X		X
TR2MT	2SN/R2AT MINETUFF	24	100R2AT	853 2SN	1436		X	X					X		X
TR4XF	R4 EXTRA FLEXIBLE SAE 100R4	63	100R4						X						
WB10	WATERBLAST MINETUFF	72													
WB15	WATERBLAST MINETUFF	73													
WB20	WATERBLAST MINETUFF	74													

HOSE TYPE			AGENCY												
Hose Series	Hose Description	Cat. Page	SAE J517	EN	ISO	ALFAGOMMA Proprietary Hose	DNV‡ GL	ABS	BV	NKK	RINA	Lloyd's Register	MSHA	USDOT	
TR5	R5 ONE WIRE BRAID	64	100R5											X	
TR5TT	R5 TEMP TECH ONE WIRE BRAID	45	100R5			X									

‡ Det Norske Veritas (DNV) approvals are with permanent (crimp) type fittings only

¶ Hose with MSHA (Mine Safety and Health Administration) approved cover will be accordingly on the layline

Listing may vary by hose style and size, for current and complete information, contact ALFAGOMMA or Piranhaflex for details.

* DOT Type All approval up to size -12

Because we continually examine ways to improve our products, we reserve the right to alter specifications or discontinue products without prior notice.



MAXIMUM RECOMMENDED OPERATING PRESSURES

The table below is intended as a guide in the selection of hose by operating pressure. It is not a guarantee. The final selection is also dependent upon the type of fluid, ambient temperature, concentration of agent, intermittent or continuous exposure,

etc. For further details on a specific hose see the respective catalog pages or consult your local ALFAGOMMA or Piranhaflex Sales Engineer or ALFAGOMMA S.p.A.

Maximum Operating Pressures (psi)

Hose Series	Hose Description	Cat. Page	Diameter															
			(in)	1/8	3/16	1/4	5/16	3/8	1/2	5/8	3/4	1	1 1/4	1 1/2	2	2 1/2	3	
			DIN	3	5	6	8	10	12	16	20	25	32	38	50	63	76	
Size	-02	-03	-04	-05	-06	-08	-10	-12	-16	-20	-24	-32	-40	-48				
ABT2K	ALFABIOTECH 2000 MINETUFF	29															2000	2000
ABT3K	ALFABIOTECH 3000 MINETUFF	30											3000	3000	3000			3000
ABT4K	ALFABIOTECH 4000 MINETUFF	31						4000	4000	4000	4000	4000	4000	4200	4000			
ABT5K	ALFABIOTECH 5000 MINETUFF	32								5000	5000	5000	5000	5000	5000	5000		
ABT5KST	ALFABIOTECH 5000 SUPERTUFF	39								5000	5000	5000	5000	5000	5000			
ABT6K	ALFABIOTECH 6000 MINETUFF	34					6550		6450	6000	6000	6000	6000	6000	6000	6000		
ABT6KST	ALFABIOTECH 6000 SUPERTUFF	40					6550		6450	6000	6000	6000	6000	6000	6000	6000		
ABTP5K	ALFABIOTECH 5500 PLUS MINETUFF	33										5500	5500					
AF3B	ALFAFOREST MINETUFF	27						7280										
AT10KOC	OIL CEMENTING SUPERTUFF	71														10000		
AT3KMT	ALFATECH 3000 MINETUFF	26				3250		3120	3000	4000	3500	3000						
AT3KST	ALFATECH 3000 SUPERTUFF	37				3250		3000	3000		3500	3000						
FLEXOR RIG	FLEXOR RIG MINETUFF ROTARY	69										5000	5000	5000	5000	3000	3000	
PF151R3	PIRANHAFLEX 100R3	46				1500	1500	1250	1000									
PF267	PIRANHAFLEX 100R7	52			3000	2750	2500	2250	2000		1250							
PF267NC	PIRANHAFLEX 100R7	52			3000	2750	2500	2250	2000		1250							
PF321TC	PIRANHAFLEX SPECIALTY	60			6000	6000												
PF344LMT	PIRANHAFLEX SPECIALTY	61				2750		2250	2000		1500	1500						
PF354	PIRANHAFLEX 100R7	48		3000	3000	2750	2500	2250	2000		1250							
PF354TL	PIRANHAFLEX 100R7	58				2750		2250	2000									
PF354NC	PIRANHAFLEX 100R7	48		3000	3000	2750	2500	2250	2000		1250							
PF354NCTL	PIRANHAFLEX 100R7	58				2750		2250	2000									
PF367	PIRANHAFLEX 100R7	51			3000	2750	2500	2250	2000		1250							
PF367NC	PIRANHAFLEX 100R7	51			3000	2750	2500	2250	2000		1250							

Because we continually examine ways to improve our products, we reserve the right to alter specifications or discontinue products without prior notice.

Hose Selection Guide



MAXIMUM RECOMMENDED OPERATING PRESSURES

The table below is intended as a guide in the selection of hose by operating pressure. It is not a guarantee. The final selection is also dependent upon the type of fluid, ambient temperature, concentration of agent, intermittent or continuous exposure,

etc. For further details on a specific hose see the respective catalog pages or consult your local ALFAGOMMA or Piranhaflex Sales Engineer or ALFAGOMMA S.p.A.

Maximum Operating Pressures (psi)

Hose Series	Hose Description	Cat. Page	Diameter															
			(in)	1/8	3/16	1/4	5/16	3/8	1/2	5/8	3/4	1	1 1/4	1 1/2	2	2 1/2	3	
			DIN	3	5	6	8	10	12	16	20	25	32	38	50	63	76	
			Size	-02	-03	-04	-05	-06	-08	-10	-12	-16	-20	-24	-32	-40	-48	
PF415CP	PIRANHAFLEX	47				1500	1500	1500	1500									
PF427	PIRANHAFLEX 100R18	57				3000		3000	3000									
PF427NC	PIRANHAFLEX 100R18	57				3000		3000	3000									
PF528	PIRANHAFLEX 100R8	56				5000		4000	3500		2250							
PF528NC	PIRANHAFLEX 100R8	56				5000		4000	3500		2250							
PF628	PIRANHAFLEX 100R8	55				5000		4000	3500		2250							
PF628TL	PIRANHAFLEX 100R8	58				5000		4000	3500									
PF628NC	PIRANHAFLEX 100R8	55				5000		4000	3500		2250							
PF628NCTL	PIRANHAFLEX 100R8	58				5000		4000	3500									
PFAN388NC	PIRANHAFLEX 100R7	53				3000		3000	3000									
PFLT364	PIRANHAFLEX 100R7	54				2750		2250	2000									
PFP354	PIRANHAFLEX 100R7	49				2750		2250	2000									
PFP354NC	PIRANHAFLEX 100R7	50				2750		2250	2000									
T1SNTT	TEMP TECH 1SN	43				3250		2610	2320		1530	1280	920	730	600			
T2SNTT	TEMP TECH 2SN	44				5850		4800	4000		3120	2400	1820	1310	1200			
TAJ3BK	ALFAJET 210	67				3000	3000	3000	3000									
TAJ3BU	ALFAJET 210	67				3000	3000	3000	3000									
TAJ5BK	ALFAJET 400	68				5850	5850	5850	5850									
TAJ5BU	ALFAJET 400	68				5850	5850	5850	5850									
TF2LT	2SC/R16 LOW TEMP	66				6000		5000	4500	4000	3500	3000						
TF2MT	2SC/R16 MINETUFF	25				6000	5500	5000	4500	4000	3500	3000	2000	1820	1500	1100	1000	
TF2ST	2SC/R16 SUPERTUFF	38				6000		5000	4500	4000	3500	3000						
TR14TB	R14 PTFE SS BRAID	65				4000	3500	3000	2600	2300	2000	1600	1000					
TR1MT	1SN/R1AT MINETUFF	23				3630	3250	3120	2610	2320	1900	1530	1280	920	730	600		
TR2MT	2SN/R2AT MINETUFF	24				5800	5000	4800	4000	3630	3120	2400	1820	1310	1200			
TR4XF	R4 EXTRA FLEXIBLE SAE 100R4	63										300	250	200	150	100	60	60

Because we continually examine ways to improve our products, we reserve the right to alter specifications or discontinue products without prior notice.



HOSES
 ONE-PIECE B SERIES
 ONE-PIECE D SERIES
 ONE-PIECE F & P SERIES
 TWO-PIECE FERRULES (A & PFR SERIES)
 TWO-PIECE INSERTS (A SERIES)
 TWO-PIECE INTERLOCK FERRULES & INSERTS (X & Z SERIES)
 QUICK RELEASE
 ASSEMBLY EQUIPMENT
 TECHNICAL INFORMATION

MAXIMUM RECOMMENDED OPERATING PRESSURES

The table below is intended as a guide in the selection of hose by operating pressure. It is not a guarantee. The final selection is also dependent upon the type of fluid, ambient temperature, concentration of agent, intermittent or continuous exposure,

etc. For further details on a specific hose see the respective catalog pages or consult your local ALFAGOMMA or Piranhaflex Sales Engineer or ALFAGOMMA S.p.A.

Maximum Operating Pressures (psi)

Hose Series	Hose Description	Cat. Page	Diameter															
			(in)	1/8	3/16	1/4	5/16	3/8	1/2	5/8	3/4	1	1 1/4	1 1/2	2	2 1/2	3	
			DIN	3	5	6	8	10	12	16	20	25	32	38	50	63	76	
			Size	-02	-03	-04	-05	-06	-08	-10	-12	-16	-20	-24	-32	-40	-48	
WB10	WATERBLAST MINETUFF	72							10000	10000		10000	10000					
WB15	WATERBLAST MINETUFF	73							16000		14500							
WB20	WATERBLAST MINETUFF	74				20000		20000	20000		20000							

Flexor 5 100R5 Reduced Bore Sizes and Working Pressures

Hose Series	Hose Description	Cat. Page	Diameter											
			(in)	3/16	1/4	5/16	13/32	1/2	5/8	7/8	1 1/8	1 3/8	1 13/16	
			Size	-04	-05	-06	-08	-10	-12	-16	-20	-24	-32	
TR5	R5 ONE WIRE BRAID	64		3000	3000	2250	2000	1750	1500	800	625	500	350	
TR5TT	R5 TEMP TECH ONE WIRE BRAID	45		3000	3000	2250	2000	1750	1500	800	625	500	350	

Because we continually examine ways to improve our products, we reserve the right to alter specifications or discontinue products without prior notice.

Hose Selection Guide



MAXIMUM RECOMMENDED OPERATING PRESSURES

The table below is intended as a guide in the selection of hose by operating pressure. It is not a guarantee. The final selection is also dependent upon the type of fluid, ambient temperature, concentration of agent, intermittent or continuous exposure,

etc. For further details on a specific hose see the respective catalog pages or consult your local ALFAGOMMA or Piranhaflex Sales Engineer or ALFAGOMMA S.p.A

Maximum Operating Pressure (mpa)

Hose Series	Hose Description	Cat. Page	Diameter														
			(in)	1/8	3/16	1/4	5/16	3/8	1/2	5/8	3/4	1	1 1/4	1 1/2	2	2 1/2	3
			DIN	3	5	6	8	10	12	16	20	25	32	38	50	63	76
			Size	-02	-03	-04	-05	-06	-08	-10	-12	-16	-20	-24	-32	-40	-48
ABT2K	ALFABIOTECH 2000 MINETUFF	29														13.79	13.79
ABT3K	ALFABIOTECH 3000 MINETUFF	30											20.68	20.68	20.68		20.68
ABT4K	ALFABIOTECH 4000 MINETUFF	31						27.58	27.58	27.58	27.58	27.58	27.58	28.96	27.58		
ABT5K	ALFABIOTECH 5000 MINETUFF	32								34.47	34.47	34.47	34.47	34.47	34.47	34.47	
ABT5KST	ALFABIOTECH 5000 SUPERTUFF	39								34.47	34.47	34.47	34.47	34.47	34.47		
ABT6K	ALFABIOTECH 6000 MINETUFF	34				45.16		44.47	41.37	41.37	41.37	41.37	41.37	41.37	41.37		
ABT6KST	ALFABIOTECH 6000 SUPERTUFF	40				45.16		44.47	41.37	41.37	41.37	41.37	41.37	41.37	41.37		
ABTP5K	ALFABIOTECH 5500 PLUS MINETUFF	33										37.92	37.92				
AF3B	ALFAFOREST MINETUFF	27						50.19									
AT10KOC	OIL CEMENTING SUPERTUFF	71													68.95		
AT3KMT	ALFATECH 3000 MINETUFF	26				22.41		21.51	20.68	27.58	24.13	20.68					
AT3KST	ALFATECH 3000 SUPERTUFF	37				22.41		20.68	20.68		24.13	20.68					
FLEXOR RIG	FLEXOR RIG MINETUFF ROTARY	69										34.47	34.47	34.47	34.47	20.68	20.68
PF151R3	PIRANHAFLEX 100R3	46				10.34	10.34	8.62	6.89								
PF267	PIRANHAFLEX 100R7	52			20.68	18.96	17.24	15.51	13.79		8.62						
PF267NC	PIRANHAFLEX 100R7	52			20.68	18.96	17.24	15.51	13.79		8.62						
PF321TC	PIRANHAFLEX SPECIALTY	60			41.37	41.37											
PF344LMT	PIRANHAFLEX SPECIALTY	61				18.96		15.51	13.79		10.34	10.34					
PF354	PIRANHAFLEX 100R7	48		20.68	20.68	18.96	17.24	15.51	13.79		8.62						
PF354TL	PIRANHAFLEX 100R7	58				18.96		15.51	13.79								
PF354NC	PIRANHAFLEX 100R7	48		20.68	20.68	18.96	17.24	15.51	13.79		8.62						
PF354NCTL	PIRANHAFLEX 100R7	58				18.96		15.51	13.79								
PF367	PIRANHAFLEX 100R7	51			20.68	18.96	17.24	15.51	13.79		8.62						
PF367NC	PIRANHAFLEX 100R7	51			20.68	18.96	17.24	15.51	13.79		8.62						
PF415CP	PIRANHAFLEX	47				10.34	10.34	10.34	10.34								

Because we continually examine ways to improve our products, we reserve the right to alter specifications or discontinue products without prior notice.



HOSES

ONE-PIECE B SERIES

ONE-PIECE D SERIES

ONE-PIECE F & P SERIES

TWO-PIECE FERRULES (A & PFR SERIES)

TWO-PIECE INSERTS (A SERIES)

TWO-PIECE INTERLOCK FERRULES & INSERTS (X & Z SERIES)

QUICK RELEASE

ASSEMBLY EQUIPMENT

TECHNICAL INFORMATION

MAXIMUM RECOMMENDED OPERATING PRESSURES

The table below is intended as a guide in the selection of hose by operating pressure. It is not a guarantee. The final selection is also dependent upon the type of fluid, ambient temperature, concentration of agent, intermittent or continuous exposure,

etc. For further details on a specific hose see the respective catalog pages or consult your local ALFAGOMMA or Piranhaflex Sales Engineer or ALFAGOMMA S.p.A

Maximum Operating Pressure (mpa)

Hose Series	Hose Description	Cat. Page	Diameter															
			(in)	1/8	3/16	1/4	5/16	3/8	1/2	5/8	3/4	1	1 1/4	1 1/2	2	2 1/2	3	
			DIN	3	5	6	8	10	12	16	20	25	32	38	50	63	76	
			Size	-02	-03	-04	-05	-06	-08	-10	-12	-16	-20	-24	-32	-40	-48	
PF427	PIRANHAFLEX 100R18	57				20.68		20.68	20.68									
PF427NC	PIRANHAFLEX 100R18	57				20.68		20.68	20.68									
PF528	PIRANHAFLEX 100R8	56				34.47		27.58	24.13									
PF528NC	PIRANHAFLEX 100R8	56				34.47		27.58	24.13									
PF628	PIRANHAFLEX 100R8	55				34.47		27.58	24.13		15.51							
PF628TL	PIRANHAFLEX 100R8	58				34.47		27.58	24.13									
PF628NC	PIRANHAFLEX 100R8	55				34.47		27.58	24.13		15.51							
PF628NCTL	PIRANHAFLEX 100R8	58				34.47		27.58	24.13									
PFAN388NC	PIRANHAFLEX 100R7	53				20.68		20.68	20.68									
PFLT364	PIRANHAFLEX 100R7	54				18.96		15.51	13.79									
PFP354	PIRANHAFLEX 100R7	49				18.96		15.51	13.79									
PFP354NC	PIRANHAFLEX 100R7	50				18.96		15.51	13.79									
T1SNTT	TEMP TECH 1SN	43				22.41		18.00	16.00		10.55	8.83	6.34	5.03	4.14			
T2SNTT	TEMP TECH 2SN	44				40.33		33.09	27.58		21.51	16.55	12.55	9.03	8.27			
TAJ3BK	ALFAJET 210	67				20.68	20.68	20.68	20.68									
TAJ3BU	ALFAJET 210	67				20.68	20.68	20.68	20.68									
TAJ5BK	ALFAJET 400	68																
TAJ5BU	ALFAJET 400	68				40.33	40.33	40.33	40.33									
TF2LT	2SC/R16 LOW TEMP	66				41.37		34.47	31.03	27.58	24.13	20.68						
TF2MT	2SC/R16 MINETUFF	25				41.37	37.92	34.47	31.03	27.58	24.13	20.68	13.79	12.55	10.34	7.58	6.89	
TF2ST	2SC/R16 SUPERTUFF	38				41.37		34.47	31.03	27.58	24.13	20.68						
TR14TB	R14 PTFE SS BRAID	65				27.58	24.13	20.68	17.93	15.86	13.79	11.03	6.89					
TR1MT	1SN/R1AT MINETUFF	23				25.03	22.41	21.51	18.00	16.00	13.10	10.55	8.83	6.34	5.03	4.14		
TR2MT	2SN/R2AT MINETUFF	24				39.99	34.47	33.09	27.58	25.03	21.51	16.55	12.55	9.03	8.27			
TR4XF	R4 EXTRA FLEXIBLE SAE 100R4	63									2.59	2.07	1.72	1.03	0.69			
WB10	WATERBLAST MINETUFF	72							68.95	68.95		68.95	68.95					

Because we continually examine ways to improve our products, we reserve the right to alter specifications or discontinue products without prior notice.

Hose Selection Guide



MAXIMUM RECOMMENDED OPERATING PRESSURES

The table below is intended as a guide in the selection of hose by operating pressure. It is not a guarantee. The final selection is also dependent upon the type of fluid, ambient temperature, concentration of agent, intermittent or continuous exposure,

etc. For further details on a specific hose see the respective catalog pages or consult your local ALFAGOMMA or Piranhaflex Sales Engineer or ALFAGOMMA S.p.A

Maximum Operating Pressure (mpa)

Hose Series	Hose Description	Cat. Page	Diameter														
			(in)	1/8	3/16	1/4	5/16	3/8	1/2	5/8	3/4	1	1 1/4	1 1/2	2	2 1/2	3
			DIN	3	5	6	8	10	12	16	20	25	32	38	50	63	76
			Size	-02	-03	-04	-05	-06	-08	-10	-12	-16	-20	-24	-32	-40	-48
WB15	WATERBLAST MINETUFF	73							110.32		99.97	0.00					
WB20	WATERBLAST MINETUFF	74				137.90		137.90	137.90		137.90						

Flexor 5 100R5 Reduced Bore Sizes and Working Pressures

Hose Series	Hose Description	Cat. Page	Diameter										
			(in)	3/16	1/4	5/16	13/32	1/2	5/8	7/8	1 1/8	1 3/8	1 13/16
			Size	-04	-05	-06	-08	-10	-12	-16	-20	-24	-32
TR5	R5 ONE WIRE BRAID	64		20.68	20.68	15.51	13.79	12.07	10.34	5.52	4.31	3.45	2.41
TR5TT	R5 TEMP TECH ONE WIRE BRAID	45		20.68	20.68	15.51	13.79	12.07	10.34	5.52	4.31	3.45	2.41

Because we continually examine ways to improve our products, we reserve the right to alter specifications or discontinue products without prior notice.



HOSES
ONE-PIECE B SERIES
ONE-PIECE D SERIES
ONE-PIECE F & P SERIES
TWO-PIECE FERRULES (A & PFR SERIES)
TWO-PIECE INSERTS (A SERIES)
TWO-PIECE INTERLOCK FERRULES & INSERTS (X & Z SERIES)
QUICK RELEASE
ASSEMBLY EQUIPMENT
TECHNICAL INFORMATION



ALFAGOMMA

**MINETUFF
HIGH ABRASION
RESISTANCE**



MINETUFF COVER

- ▲ **EXCELLENT ABRASION RESISTANCE (10 TIMES HIGHER THAN EN-ISO 6945 REQUIREMENT)**
- ▲ **HIGH OZONE RESISTANCE (10 TIMES MORE THAN THE STANDARD)**
- ▲ **MSHA APPROVED COVER**
- ▲ **ALTERNATIVE TO PROTECTIVE SLEEVE IN APPLICATIONS REQUIRING ABRASION RESISTANCE**

HOSES
ONE-PIECE B SERIES
ONE-PIECE D SERIES
ONE-PIECE F & P SERIES
TWO-PIECE FERRULES (A & PFR SERIES)
TWO-PIECE INSERTS (A SERIES)
TWO-PIECE INTERLOCK FERRULES & INSERTS (X & Z SERIES)
QUICK RELEASE
ASSEMBLY EQUIPMENT
TECHNICAL INFORMATION

New Economical Alternative for High Abrasion Applications

MINETUFF is a special cover for hydraulic hose, which dramatically increase resistance to environmental and severe application damages.

Features:

- Excellent abrasion resistance (25 times higher than EN-ISO 6945 requirements)
- Reduces the need for any protective sleeve in applications requiring high abrasion resistance
- UV and ozone resistance (hose ageing reduction)

Applications:

- Mining and earth-moving machines (MINETUFF is abrasion resistant)
- Machineries for forestry (MINETUFF is resistant to impact-caused damage)
- Offshore applications (MINETUFF is ozone and UV resistant)
- Machineries for chemical plants (MINETUFF is resistant to most of the chemical agents)

Abrasion Resistance:

Tests according to EN-ISO 6945 norms (weight 50+/-5N) state that the maximum allowed loss of weight is 0.5g:

- Standard cover: 0.15g after 2,000 cycles
- MINETUFF cover: 0.02g after 2,000 cycles

Flame Resistance:

MINETUFF cover is MSHA IC-152/16 approved flame resistance.

UV Rays and Chemicals:

MINETUFF cover is resistant to UV, animal fats, acids, and any other environmental stress.



Tests run according to EN-ISO, DIN and SAE specs show that MINETUFF can guarantee performances, highly superior to the standards.

Futhermore, MINETUFF was developed to be flame resistant, and it passed the Mine Safety and Health Administration severe tests.

MINETUFF is the solution that, together with the Alfabiotech range, will help satisfy any demand for elevated performances and diameters.

Single wire braid hydraulic hose on easy-to-handle reels – TR1MT - MINETUFF



TR1MT – Single wire braid
Meets or exceeds
ISO 1436-1 - SAE 100 R1AT/R1S
EN 853 1SN
MSHA IC-152/16 approved flame
resistance



General Applications:

Medium pressure service with high temperature petroleum-based hydraulic fluids, hot oil, grease, lubricants and crude oils, air and water. For air or gas application above 250 psi (1.7 Mpa) the cover should be pin-pricked.

Construction:

Tube – Seamless synthetic rubber, black... oil-resistant.

Reinforcement – High tensile steel wire braid.

Cover – Synthetic rubber, black... weather, oil, fuel, ozone and abrasion-resistant.

Service Temperature Range:

-40°F (-40°C) to +212°F (+100°C) constant operation.

Air maximum temperature: +160°F (+70°C)

Note: Operating temperatures in excess of +212°F (+100°C) may materially reduce the life of the hose.

Branding:

ALFAGOMMA FLEXOR 1SN ID ...WP ...MPa (...PSI) – SAE 100 R1AT – EN 853 1SN MSHA IC-152/16...Q/YR DN ...

Nominal Specifications

Series Number	Size Code	ID		OD		Max Working [†] Pressure (psi)	Min. Bend. Radius		Weight (lbs/ft)	Coupling Recommendations	
		(in)	(mm)	(in)	(mm)		(in)	(mm)		AlfaCrimp One-Piece	Two-Piece Ferrule Non-Skive
TR1MT	03	3/16	4.8	0.44	11.2	3630	3.6	090.0	0.10		AF1
TR1MT	04	1/4	6.4	0.50	12.7	3250	3.9	099.1	0.13	B	AF1
TR1MT	05	5/16	7.9	0.56	14.2	3120	4.5	114.3	0.16	B	AF1
TR1MT	06	3/8	9.5	0.65	16.5	2610	5.1	129.5	0.20	B	AF1
TR1MT	08	1/2	12.7	0.78	19.9	2320	7.1	180.3	0.26	B	AF1
TR1MT	10	5/8	15.9	0.91	23.0	1900	7.9	200.7	0.29	B	AF1
TR1MT	12	3/4	19.1	1.06	27.0	1530	9.5	241.3	0.37	B	AF1
TR1MT	16	1	25.4	1.38	35.0	1280	11.8	299.7	0.59	B	AF1
TR1MT	20	1 1/4	31.8	1.66	42.1	920	16.5	419.1	0.71		AF1
TR1MT	24	1 1/2	38.1	1.94	49.2	730	19.7	500.4	0.90		AF1
TR1MT	32	2	50.8	2.46	62.4	600	24.8	629.9	1.24		AF1

[†] Minimum burst pressure 4-to-1 safety factor.

Freight: Hydraulic Hose can be combined with other KOA products for qualifying prepaid freight orders.

Because we continually examine ways to improve our products, we reserve the right to alter specifications or discontinue products without prior notice.

TR2MT - 2SN/R2AT MINETUFF



Double wire braid hydraulic hose on easy-to-handle reels –TR2MT - MINETUFF

TR2MT – Double wire braid

Meets or exceeds SAE 100 R2AT
ISO 1436-1 - SAE 100 R2AT/R2S
EN 853 2SN MSHA IC-152/16
approved flame resistance



General Applications:

Medium pressure service with high temperature petroleum-based hydraulic fluids, hot oil, grease, lubricants and crude oils, air and water. For air or gas application above 250 PSI (1.7 Mpa) the cover should be pin-pricked.

Construction:

Tube – Seamless synthetic rubber, black... oil-resistant.

Reinforcement – High tensile steel wire braid.

Cover – Synthetic rubber, black... weather, oil, fuel, ozone and abrasion-resistant.

Service Temperature Range:

-40°F (-40°C) to +212°F (+100°C) constant operation.

Air maximum temperature: +160°F (+70°C)

Note: Operating temperatures in excess of +212°F (+100°C) may materially reduce the life of the hose.

Branding

ALFAGOMMA FLEXOR 2SN ID ...WP ...MPa (...PSI) – SAE 100R2AT - EN 853 2SN DN ... MSHA IC-152/16 - Q/YR

Nominal Specifications

Series Number	Size Code	ID		OD		Max Working [†] Pressure (psi)	Min. Bend. Radius		Weight (lbs/ft)	Coupling Recommendations		
		(in)	(mm)	(in)	(mm)		(in)	(mm)		AlfaCrimp One-Piece	Two-Piece Ferrule Non-Skive	
TR2MT	04	1/4	6	0.57	14.5	5800	4.0	100	0.22	B	AF2	
TR2MT	05	5/16	8	0.63	16.1	5000	4.6	115	0.23	B	AF2	
TR2MT	06	3/8	9.5	0.72	18.2	4800	4.9	124.5	0.32	B	AF2	
TR2MT	08	1/2	12.7	0.84	21.3	4000	6.8	172.7	0.36	B	D	AF2
TR2MT	10	5/8	15.9	0.96	24.5	3630	7.8	198.1	0.45	B	D	AF2
TR2MT	12	3/4	19.1	1.13	28.6	3120	9.4	238.8	0.58	B	D	AF2
TR2MT	16	1	25.4	1.44	36.6	2400	11.8	299.7	0.83	B	D	AF2
TR2MT	20	1 1/4	31.8	1.81	46.0	1820	16.5	419.1	1.19		D	AF2
TR2MT	24	1 1/2	38.1	2.08	52.8	1310	19.6	497.8	1.37		D	AF2
TR2MT	32	2	50.8	2.58	65.6	1200	24.8	629.9	1.86		D	AF2

[†] Minimum burst pressure 4-to-1 safety factor.

Freight: Hydraulic Hose can be combined with other KOA products for qualifying prepaid freight orders.

Because we continually examine ways to improve our products, we reserve the right to alter specifications or discontinue products without prior notice.



HOSES

ONE-PIECE B SERIES

ONE-PIECE D SERIES

ONE-PIECE F & P SERIES

TWO-PIECE FERRULES (A & PFR SERIES)

TWO-PIECE INSERTS (A SERIES)

TWO-PIECE INTERLOCK FERRULES & INSERTS (X & Z SERIES)

QUICK RELEASE

ASSEMBLY EQUIPMENT

TECHNICAL INFORMATION

Double compact wire braid hydraulic hose on easy-to-handle reels – TF2MT



TF2MT– Double wire braid

Meets or exceeds EN 857 2SC and exceeds SAE 100 R16 MSHA IC-152/16 approved flame resistance



General Applications:

High pressure service with tight bends with petroleum-based hydraulic fluids, water/glycol, water- and fire-resistant hydraulic fluids, hot oil, grease, lubricants, crude oil, fuel oils, air and water. Excellent impulse performance, exceeding 1,000,000 cycles when tested with appropriate ALFAGOMMA couplings. For air or gas application above 250 PSI (1.7 Mpa) the cover should be pin-pricked.

Construction:

Tube – Synthetic rubber, black.

Reinforcement – Two high tensile steel wire braids, separated by a layer of synthetic rubber.

Cover – Synthetic rubber, black... weather, oil, fuel, ozone and excellent abrasion-resistant.

Service Temperature Range:

-40°F (-40°C) to +212°F (+100°C) constant operation.

Maximum operating temperature:

+257°F (+125°C)

Air maximum temperature: +160°F (+70°C)

Note: Operating temperatures in excess of +212°F (+100°C) may materially reduce the life of the hose.

Branding:

ALFAGOMMA FLEXOPAK 2 ID ...WP ... MPa (... PSI) – EXCEEDS SAE 100 R16 – EN 857 2SC ... DN MSHA IC-152/16 ...Q/YR

Nominal Specifications

Series Number	Size Code	ID		OD		Max. Working Pressure (psi)	Min. Bend. Radius		Weight (lbs/ft)	Coupling Recommendations			
		(in)	(mm)	(in)	(mm)		(in)	(mm)		AlfaCrimp One-Piece	Two-Piece Ferrule Non-Skive		
TF2MT	04	1/4	6.4	0.51	13.0	6000	2.0	50.8	0.18	B		AF1	
TF2MT	05	5/16	8.0	0.57	14.5	5500	2.2	57.0	0.22	B		AF1	
TF2MT	06	3/8	9.5	0.66	18.8	5000	2.2	55.9	0.26	B		AF1	
TF2MT	08	1/2	12.7	0.81	20.6	4500	3.5	88.9	0.34	B		AF1	
TF2MT	10	5/8	15.9	0.91	23.2	4000	4.0	101.6	0.41	B		AF1	
TF2MT	12	3/4	19.1	1.09	27.6	3500	4.7	119.4	0.53	B		AF1	AF2
TF2MT	16	1	25.4	1.40	35.5	3000	6.0	152.4	0.86	B	D	AF1	AF2
TF2MT	20	1 1/4	31.8	1.65	42.0	2000	8.3	210.8	0.92		D		AF1
TF2MT	24	1 1/2	38.1	1.96	49.9	1820	16.9	429.3	1.32		D		AF1
TF2MT	32	2	50.8	2.50	63.5	1500	21.6	548.6	1.71		D		AF1
TF2MT	40	2 1/2	63.5	3.01	76.4	1100	28.3	718.8	2.21	B			
TF2MT	48	3	76.2	3.54	90.0	1000	34.6	878.8	2.58	B			

† Minimum burst pressure 4-to-1 safety factor.

Freight: Hydraulic Hose can be combined with other KOA products for qualifying prepaid freight orders.

Because we continually examine ways to improve our products, we reserve the right to alter specifications or discontinue products without prior notice.

AT3KMT - 1SC/R17 ALFATECH MINETUFF



One and two wire braid reinforced hydraulic hose with MINETUFF Cover – AT3KMT

AT3KMT – One and two wire braid

Meets or exceeds the working and burst pressure requirements of SAE 100 R17 –

Meets or exceeds EN 857 1SC
(Sizes 04 and 06)

MSHA IC-152/16 approved flame resistance

1 wire braid up thru 1/2"

2 wire braid all sizes over 1/2"



General Applications:

Medium pressure service with petroleum based hydraulic fluids such as hot oil, grease, lubricants, and crude oils, air and water. Developed to withstand punishing conditions and to meet increasing pressure pulsing, flexing and temperature demands not currently covered by International specifications.

Features extraordinary flexibility, excellent bend radii properties, superior performance under flex-impulse conditions, and exceptional long life. Tested over 1,000,000 impulse cycles at 120% of rated working pressure.

Construction:

Tube – Synthetic rubber, black... oil-resistant.

Reinforcement – One or two layers of high tensile steel wire braid reinforcement.

Cover – Synthetic rubber, black... oil, fuel, weather, ozone and abrasion-resistant.

Service Temperature Range:

-40°F (-40°C) to +212°F (+100°C) constant operation.

Maximum operating temperature:

+250°F (+121°C)

Air maximum temperature: +175°F (+80°C)

Note: Operating temperatures in excess of +212°F (+100°C) may materially reduce the life of the hose.

Branding:

ALFAGOMMA AT3K MINETUFF ID...WP

MPa... MPa... SAE 100R17 - DN... MSHA IC-152/16 - Q/YR

Nominal Specifications

Series Number	Size Code	ID		OD		Max Working† Pressure (psi)	Min. Bend. Radius		Weight (lbs/ft)	Coupling Recommendations			
		(in)	(mm)	(in)	(mm)		(in)	(mm)		AlfaCrimp One-Piece	Two-Piece Ferrule Non-Skive		
AT3KMT	04	1/4	6.4	0.47	2.0	3250	1.9	48.3	0.12	B		AF1	
AT3KMT	06	3/8	9.5	0.61	15.4	3120	2.5	63.5	0.18	B		AF1	
AT3KMT	08	1/2	12.7	0.76	19.2	3000	3.5	88.9	0.25	B		AF1	
AT3KMTⓈ	10	5/8	15.9	0.91	23.2	4000	4.0	101.6	0.41	B		AF1	
AT3KMTⓈ	12	3/4	19.1	1.09	27.6	3500	4.7	119.4	0.53	B		AF1	AF2
AT3KMTⓈ	16	1	25.4	1.40	35.5	3000	6.0	152.4	0.86	B	D	AF1	AF2

† Minimum burst pressure 4-to-1 safety factor.

Freight: Hydraulic Hose can be combined with other KOA products for qualifying prepaid freight orders.

Ⓢ Double steel wire braid . . . all others are single wire braid.

Because we continually examine ways to improve our products, we reserve the right to alter specifications or discontinue products without prior notice.



HOSES
ONE-PIECE B SERIES
ONE-PIECE D SERIES
ONE-PIECE F & P SERIES
TWO-PIECE FERRULES (A & PFR SERIES)
TWO-PIECE INSERTS (A SERIES)
TWO-PIECE INTERLOCK FERRULES & INSERTS (X & Z SERIES)
QUICK RELEASE
ASSEMBLY EQUIPMENT
TECHNICAL INFORMATION



NEW

**AF3B-
3 wire braid**

MSHA IC-152/16
approved flame
resistance



General Applications:

Hydraulic system with petroleum or water/glycol based fluids, fuel, lubricating oils. Specially designed for ultra low temperature applications.

Construction:

- Tube** – Oil resistant ultra low temperature synthetic rubber.
- Reinforcement** – Three high tensile steel braids.
- Cover** – Oil, water, ozone and ultra low temperature resistant synthetic rubber.

Service Temperature Range:

-67°F (-55°C) to +212°F (+100°C) constant operation.

Air maximum temperature: +160°F (+70°C)

Branding:

ALFAGOMMA ALFAFOREST MINETUFF ID...WP MPa 50 (7280 PSI)... MSHA IC-152/16 - Q/YR - MADE IN ITALY

Nominal Specifications

Series Number	Size Code	ID		OD		Max Working [†] Pressure (psi)	Min. Bend. Radius		Weight (lbs/ft)	Coupling Recommendations	
		(in)	(mm)	(in)	(mm)		(in)	(mm)		Two-Piece	Ferrule Skive
AF3B	06	3/8	9.5	0.85	21.7	7280	4.7	119.4	0.52	AS4	

Note: DH3SPT also available in 3/8" size for customers requiring ABS Approvals

Freight: Hydraulic Hose can be combined with other KOA products for qualifying prepaid freight orders.

Because we continually examine ways to improve our products, we reserve the right to alter specifications or discontinue products without prior notice.

- HOSES
- ONE-PIECE B SERIES
- ONE-PIECE D SERIES
- ONE-PIECE F & P SERIES
- TWO-PIECE FERRULES (A & PFR SERIES)
- TWO-PIECE INSERTS (A SERIES)
- TWO-PIECE INTERLOCK FERRULES & INSERTS (X & Z SERIES)
- QUICK RELEASE
- ASSEMBLY EQUIPMENT
- TECHNICAL INFORMATION

alfabiotech

NEW EXTRA FLEXIBLE
BIO OIL RESISTANT
HOSE RANGE



alfabiotech

- ▲ SPECIALLY DESIGNED FOR BIO OIL FULL COMPATIBILITY
- ▲ EXTREME FLEXIBILITY: UP TO 50% BETTER BEND RADIUS COMPARED TO SAE 100R
- ▲ MINETUFF COVER FOR TOP ABRASION & OZONE RESISTANCE
- ▲ MSHA-APPROVED FIRE RESISTANT COVER
- ▲ ISO 18752/CC 1,000,000+ IMPULSE CYCLES ALL SIZES



BEND RADIUS
Standard SAE 100R

BEND RADIUS
reduced up to 50%

Alfabiotech 2000 MINETUFF - ABT2K Hydraulic Hose



ABT2K- 4 Spirals

MSHA IC-152/16 approved flame resistance

ISO 18752/CC 1,000,000+ impulse cycles all sizes



General Applications:

Developed to withstand very demanding conditions very high performance in pressure, pulsing and flexing.

Construction:

Tube – Oil resistant synthetic rubber and biodegradable hydraulic fluids.

Reinforcement – Four high tensile steel spirals.

Cover – Abrasion, ozone and hydrocarbon resistant synthetic rubber.

Service Temperature Range:

-40°F (-40°C) to +250°F (+121°C)

Branding:

Alfagomma Alfabiotech 2K Minetuff 2000 PSI Hydraulic Service - 3200 PSI Slim Hole Rotary Service MSHA IC-152/16 Made in Italy

Length:

100 feet. 200 foot lengths available upon request.

Nominal Specifications

Series Number	Size Code	ID		OD		Max Working [†] Pressure (psi)	Min. Bend. Radius		Weight (lbs/ft)	Coupling Recommendations	
		(in)	(mm)	(in)	(mm)		(in)	(mm)		Two-Piece	
										Ferrule Skive	Ferrule Interlock
ABT2K	40	2 1/2	63.5	3.11	79.0	2000*	28.3	718.8	3.33	VS4	XF1
ABT2K	48	3	76.2	3.64	92.5	2000*	33.0	838.2	3.64	VS4	

*Note: Slim Hole Rotary Hose Working Pressure 3200 psi, Hydraulic Service 2000 psi.

† Minimum burst pressure 4-to-1 hydraulic service/2.5-to-1 slim hole rotary.

Freight: Hydraulic Hose can be combined with other KOA products for qualifying prepaid freight orders.

Because we continually examine ways to improve our products, we reserve the right to alter specifications or discontinue products without prior notice.

ABT3K - Alfabiotech 3000 MINETUFF



Alfabiotech 3000 MINETUFF - ABT3K Hydraulic Hose

HOSES

ONE-PIECE B SERIES

ONE-PIECE D SERIES

ONE-PIECE F & P SERIES

TWO-PIECE FERRULES (A & PFR SERIES)

TWO-PIECE INSERTS (A SERIES)

TWO-PIECE INTERLOCK FERRULES & INSERTS (X & Z SERIES)

QUICK RELEASE

ASSEMBLY EQUIPMENT

TECHNICAL INFORMATION



ABT3K - 4 or 6 wire spiral

Exceeds SAE 100R12 all sizes
ISO 18752/CC 1,000,000+ impulse cycles all sizes
MSHA IC-152/16 approved flame resistance



General Applications:

Developed to withstand very demanding conditions very high performance in pressure, pulsing and flexing.

Construction:

Tube – Oil resistant synthetic rubber and biodegradable hydraulic fluids.
Reinforcement – Four/six high tensile steel spirals.
Cover – Abrasion, ozone and hydrocarbon resistant synthetic rubber.

Service Temperature Range:

-40°F (-40°C) to +250°F (+121°C)

Branding:

ALFAGOMMA ALFABIOTECH 3K MINETUFF ... WP 21 MPa (3000 PSI) - ISO 18752/CC - exceeds SAE 100 R12 - MSHA IC-152/16 - MADE IN ITALY
-48 Branding: Alfagomma Alfabiotech 3K 3000 PSI Hydraulic Service - 5000 PSI Slim Hole Rotary Service - MSHA IC-152/16

Length:

200 feet from 1 1/4" to 1 1/2" - 100 feet for 2" and 3"

Nominal Specifications

Series Number	Size Code	ID		OD		Max Working [†] Pressure (psi)	Min. Bend. Radius		Weight (lbs/ft)	Coupling Recommendations		
		(in)	(mm)	(in)	(mm)		(in)	(mm)		AlfaCrimp One-Piece	Ferrule Non-Skive	Ferrule Skive & Interlock
ABT3K	20	1 1/4	31.8	1.80	47.5	3000	9.0	228.6	1.52	D	AF4	AS4
ABT3K	24	1 1/2	38.1	2.04	51.8	3000	16.5	419.1	1.86	D	AF4	AS4
ABT3K	32	2	50.8	2.63	66.8	3000	22.0	558.8	2.69	D		AS4
ABT3K	48	3	76.2	3.76	95.6	3000*	35.4	899.2	5.35			ZF1

*Note: Slim Hole Rotary Hose Working Pressure 5000 psi, Hydraulic Service 3000 psi. Minimum burst pressure 4-to-1 hydraulic service, 2.5-to-1 slim hole rotary.

Freight: Hydraulic Hose can be combined with other KOA products for qualifying prepaid freight orders.

Because we continually examine ways to improve our products, we reserve the right to alter specifications or discontinue products without prior notice.



Alfabiotech 4000 MINETUFF - ABT4K Hydraulic Hose



ABT4K - 4 wire spiral

Exceeds SAE 100R12 sizes 3/4" and 1"
 Exceeds EN856 4SH sizes 1 1/2" and 2"
 ISO 18752/CC 1,000,000+ impulse cycles all sizes
 MSHA IC-152/16 approved flame resistance



General Applications:

Developed to withstand very demanding conditions very high performance in pressure, pulsing and flexing.

Construction:

Tube – Oil resistant synthetic rubber and biodegradable hydraulic fluids.

Reinforcement – Four high tensile steel spirals.

Cover – Abrasion, ozone and hydrocarbon resistant synthetic rubber.

Service Temperature Range:

-40°F (-40°C) to +250°F (+121°C)

Branding:

ALFAGOMMA ALFABIOTECH 4K MINETUFF ...
 WP 28 MPa (4000 PSI) - ISO 18752/CC - MSHA IC-152/16 - MADE IN ITALY

Length:

Random up to 1" - 200 feet from 1 1/4" to 2"

Nominal Specifications

Series Number	Size Code	ID		OD		Max Working Pressure (psi)	Min. Bend. Radius		Weight (lbs/ft)	Coupling Recommendations		
		(in)	(mm)	(in)	(mm)		(in)	(mm)		AlfaCrimp One-Piece	Two-Piece	
											Ferrule Non-Skive	Ferrule Skive & Interlock
ABT4K	06	3/8	9.5	0.79	20.1	4000	2.9	73.7	0.42	D	AF4	
ABT4K	08	1/2	12.7	0.91	23.1	4000	3.5	88.9	0.51	D	AF4	
ABT4K	10	5/8	15.9	1.04	26.4	4000	4.6	116.8	0.63	D	AF4	
ABT4K	12	3/4	19.1	1.16	29.5	4000	4.7	119.4	0.83	D	AF4	AS4
ABT4K	16	1	25.4	1.48	37.6	4000	5.9	149.9	1.11	D	AF4	AS4
ABT4K	20	1 1/4	31.8	1.80	45.7	4000	10.2	259.1	1.53	D	AF4	
ABT4K	24	1 1/2	38.1	2.04	51.8	4200	16.5	419.1	1.99			XF2
ABT4K	32	2	50.8	2.63	66.8	4000	20.8	528.3	3.01	F		XF2

† Minimum burst pressure 4-to-1 safety factor.

Freight: Hydraulic Hose can be combined with other KOA products for qualifying prepaid freight orders.

Because we continually examine ways to improve our products, we reserve the right to alter specifications or discontinue products without prior notice.

ABT5K - Alfabiotech 5000 MINETUFF



HOSES

ONE-PIECE B SERIES

ONE-PIECE D SERIES

ONE-PIECE F & P SERIES

TWO-PIECE FERRULES (A & PFR SERIES)

TWO-PIECE INSERTS (A SERIES)

TWO-PIECE INTERLOCK FERRULES & INSERTS (X & Z SERIES)

QUICK RELEASE

ASSEMBLY EQUIPMENT

TECHNICAL INFORMATION

Alfabiotech 5000 MINETUFF - ABT5K Hydraulic Hose

ABT5K - 4 or 6 wire spiral

Exceeds EN856 4SP sizes 5/8", 3/4" and 1"

Exceeds EN856 4SH sizes 1 1/4"

Exceeds SAE 100R13 sizes 5/8" through 2"

ISO 18752/CC 1,000,000+ impulse cycles all sizes

MSHA IC-152/16 approved flame resistance



General Applications:

Developed to withstand very demanding conditions very high performance in pressure, pulsing and flexing.

Construction:

Tube – Oil resistant synthetic rubber and biodegradable hydraulic fluids.

Reinforcement – Four/six high tensile steel spirals.

Cover – Abrasion, ozone and hydrocarbon resistant synthetic rubber.

Service Temperature Range:

-40°F (-40°C) to +250°F (+121°C)

Branding:

ALFAGOMMA ALFABIOTECH 5K MINETUFF ... WP 35 MPa (5000 PSI) - ISO 18752/CC - MSHA IC-152/16 - MADE IN ITALY

Length:

Random up to 1" - 200 feet from 1 1/4" to 1 1/2" - 100 feet from 2" to 2 1/2"

Nominal Specifications

Series Number	Size Code	ID		OD		Max Working Pressure (psi)	Min. Bend. Radius		Weight (lbs/ft)	Coupling Recommendations		
		(in)	(mm)	(in)	(mm)		(in)	(mm)		AlfaCrimp One-Piece	Two-Piece	
											Ferrule Skive	Ferrule Interlock
ABT5K	10	5/8	15.9	1.04	26.3	5000	5.5	139.7	0.63		AS4	
ABT5K	12	3/4	19.1	1.22	31.0	5000	5.9	149.9	0.83	F	AS4	XF2
ABT5K	16	1	25.4	1.48	37.6	5000	7.0	177.8	1.13	D	AS4	XF2
ABT5K	20	1 1/4	31.8	1.80	45.8	5000	11.0	279.4	1.70	F		XF2
ABT5K	24	1 1/2	38.1	2.22	56.5	5000	19.6	497.8	3.02	F		XF1
ABT5K	32	2	50.8	2.76	70.2	5000	21.6	548.6	4.14	F		XF1
ABT5K	40	2 1/2	63.5	3.26	82.8	5000	32.3	820.4	5.08			ZF1

† Minimum burst pressure 4-to-1 safety factor.

Freight: Hydraulic Hose can be combined with other KOA products for qualifying prepaid freight orders.

Because we continually examine ways to improve our products, we reserve the right to alter specifications or discontinue products without prior notice.



Alfabiotech 5500 PLUS MINETUFF - ABTP5K Hydraulic Hose



ABTP5K - 4 wire spiral

Exceeds SAE 100R13 all sizes
 ISO 18752/CC 1,000,000+ impulse cycles all sizes
 MSHA IC-152/16 approved flame resistance



General Applications:

Developed to withstand very demanding conditions very high performance in pressure, pulsing and flexing.

Construction:

Tube – Oil resistant synthetic rubber and biodegradable hydraulic fluids.

Reinforcement – Four high tensile steel spirals.

Cover – Abrasion, ozone and hydrocarbon resistant synthetic rubber.

Service Temperature Range:

-40°F (-40°C) to +250°F (+121°C)

Branding:

ALFAGOMMA ALFABIOTECH 5K PLUS MINETUFF ... WP 38 MPa (5500 PSI) - exceeds ISO 18752/CC - SAE 100 R13 - MSHA IC-152/16 - MADE IN ITALY

Length:

Random

Nominal Specifications

Series Number	Size Code	ID		OD		Max Working [†] Pressure (psi)	Min. Bend. Radius		Weight (lbs/ft)	Coupling Recommendations	
		(in)	(mm)	(in)	(mm)		(in)	(mm)		Two-Piece	
							Ferrule Skive	Ferrule Interlock			
ABTP5K	12	3/4	19.1	1.22	31.0	5500	7.1	180.3	0.89	AS4	XF2
ABTP5K	16	1	25.4	1.51	38.3	5500	8.3	210.8	1.30		XF2

[†] Minimum burst pressure 4-to-1 safety factor.

Freight: Hydraulic Hose can be combined with other KOA products for qualifying prepaid freight orders.

ABT6K - Alfabiotech 6000 MINETUFF



HOSES

ONE-PIECE B SERIES

ONE-PIECE D SERIES

ONE-PIECE F & P SERIES

TWO-PIECE FERRULES (A & PFR SERIES)

TWO-PIECE INSERTS (A SERIES)

TWO-PIECE INTERLOCK FERRULES & INSERTS (X & Z SERIES)

QUICK RELEASE

ASSEMBLY EQUIPMENT

TECHNICAL INFORMATION

Alfabiotech 6000 MINETUFF - ABT6K Hydraulic Hose

ABT6K - 4 or 6 wire spiral

Exceeds EN856 4SP sizes 1/4", 3/8" and 1/2"

Exceeds EN856 4SH sizes 3/4" and 1"

Exceeds SAE 100R15 sizes 1" through 2"

ISO 18752/CC 1,000,000+ impulse cycles all sizes

MSHA IC-152/16 approved flame resistance



General Applications:

Developed to withstand very demanding conditions very high performance in pressure, pulsing and flexing.

Construction:

Tube – Oil resistant synthetic rubber and biodegradable hydraulic fluids.

Reinforcement – Four/six high tensile steel spirals.

Cover – Abrasion, ozone and hydrocarbon resistant synthetic rubber.

Service Temperature Range:

-40°F (-40°C) to +250°F (+121°C)

Branding:

ALFAGOMMA ALFABIOTECH 6K MINETUFF ... WP 45 MPa (6550 PSI) - ISO 18752/CC- MSHA IC- 152/16 - MADE IN ITALY

Length:

Random up to 1" - 200 feet from 1 1/4" to 1 1/2" - 100 feet for 2"

Nominal Specifications

Series Number	Size Code	ID		OD		Max Working [†] Pressure (psi)	Min. Bend. Radius		Weight (lbs/ft)	Coupling Recommendations		
		(in)	(mm)	(in)	(mm)		(in)	(mm)		AlfaCrimp One-Piece	Two-Piece	
											Ferrule Skive	Ferrule Interlock
ABT6K	4	1/4	6.4	0.68	17.3	6550	2.4	61.0	0.37		AS4	
ABT6K	6	3/8	9.5	0.79	20.1	6450	3.0	76.2	0.42		AS4	
ABT6K	8	1/2	12.7	0.91	23.0	6000	3.5	88.9	0.51		AS4	
ABT6K	10	5/8	15.9	1.11	28.2	6000	7.1	180.3	0.81			XF1
ABT6K	12	3/4	19.1	1.24	31.4	6000	8.2	208.3	0.97	F		XF2
ABT6K	16	1	25.4	1.50	38.2	6000	9.8	248.9	1.32	F		XF2
ABT6K	20	1 1/4	31.8	1.94	49.3	6000	17.5	444.5	2.29	F		XF1
ABT6K	24	1 1/2	38.1	2.22	56.5	6000	20.8	528.3	3.02			XF1
ABT6K	32	2	50.8	2.80	71.0	6000	25.5	647.7	4.37			ZF1

[†] Minimum burst pressure 4-to-1 safety factor.

Freight: Hydraulic Hose can be combined with other KOA products for qualifying prepaid freight orders.

Because we continually examine ways to improve our products, we reserve the right to alter specifications or discontinue products without prior notice.





HOSES

ONE-PIECE B SERIES

ONE-PIECE D SERIES

ONE-PIECE F & P SERIES

TWO-PIECE FERRULES (A & PFR SERIES)

TWO-PIECE INSERTS (A SERIES)

TWO-PIECE INTERLOCK FERRULES & INSERTS (X & Z SERIES)

QUICK RELEASE

ASSEMBLY EQUIPMENT

Because we continually examine ways to improve our products, we reserve the right to alter specifications or discontinue products without prior notice.

- HOSES
- ONE-PIECE B SERIES
- ONE-PIECE D SERIES
- ONE-PIECE F & P SERIES
- TWO-PIECE FERRULES (A & PFR SERIES)
- TWO-PIECE INSERTS (A SERIES)
- TWO-PIECE INTERLOCK FERRULES & INSERTS (X & Z SERIES)
- QUICK RELEASE
- ASSEMBLY EQUIPMENT
- TECHNICAL INFORMATION

SUPERTUFF cover hydraulic hose helps reduce downtime

In order to help customers significantly reduce downtime costs, created by the need to replace hoses on hydraulic equipment, as a result of premature failure due to wire reinforcement exposure, ALFAGOMMA has developed SUPERTUFF, a new cover material.

All of the hydraulic hoses illustrated in this catalog are available with the new SUPERTUFF cover. Contact Kuriyama of America for details.

SUPERTUFF dramatically increases resistance to external damage from both the working environment and routing of hoses in areas which can be exposed to severe abrasion or impact.

SUPERTUFF's abrasion resistance is derived from a low coefficient of friction allowing it to slide over rough surfaces. Tests made to European and U.S. specifications show that SUPERTUFF outperforms standard rubber covers as well as polyurethane covers by a huge margin. These and other technical details are available upon request.

ALFAGOMMA SUPERTUFF should be of interest to manufacturers of machinery that utilizes flexible hydraulic lines that are exposed to extreme external conditions. Even standard hose installations which have previously used a plastic spiral strip over the hose cover can benefit from using a hose with a SUPERTUFF cover.

Loosely applied protective coverings that have traditionally been used can expose weak points and become detached during impulse, abrasion or impact. SUPERTUFF is not a separate layer of material added to an existing hose. It is an integrally bonded part of the hose itself. The cover adhesion levels of SUPERTUFF exceed European Norms and, because it is bonded, SUPERTUFF will contract and expand under impulse pressure together with the rest of the hose without becoming detached.



A few of the many typical applications where this new product can prolong the life expectancy of hydraulic hose are:

APPLICATION	BENEFITS OF SUPERTUFF COVER
Mining & Earthmoving Equipment	SUPERTUFF resists abrasion
Forestry Equipment	SUPERTUFF resists impact damage
Offshore Oil Rigs	SUPERTUFF resists high ozone and UV exposure
Sub Sea Applications	SUPERTUFF is water repellent – no absorption
Equipment for the Chemical Process Industries	SUPERTUFF resists most chemicals

Because we continually examine ways to improve our products, we reserve the right to alter specifications or discontinue products without prior notice.

Single and double compact wire braid hydraulic hose with SUPERTUFF cover – AT3KST



AT3KST – Single or double wire braid

Meets or exceeds SAE 100 R17
 Meets or exceeds EN 857 1SC
 (Sizes -04 and -06)
 MSHA IC-152/7 approved flame resistance



General Applications:

Medium pressure service with petroleum-based hydraulic fluids, hot oil, grease, lubricants and crude oils, air and water. For air or gas application above 250 PSI (1.7 Mpa) the cover should be pin-pricked.

Construction:

Tube – Synthetic rubber, black.

Reinforcement – One or two layer high tensile steel wire braid.

Cover – Synthetic rubber, black... weather, oil, fuel, ozone and abrasion-resistant.

Service Temperature Range:

-40°F (-40°C) to +212°F (+100°C) constant operation.

Maximum operating temperature:

+257°F (+125°C)

Air maximum temperature: +160°F (+70°C)

Note: Operating temperatures in excess of 212°F (100°C) may materially reduce the life of the hose.

Branding:

ALFAGOMMA AT3K SUPERTUFF ID ...WP ... MPa (...PSI) – SAE 100R17 – DN ... MSHA IC-152/7 - Q/YR

Note: Sizes -04 and -06 include “EN 857 1SC” on layline.

Nominal Specifications

Series Number	Size Code	ID		OD		Max Working [†] Pressure (psi)	Min. Bend. Radius		Weight (lbs/ft)	Coupling Recommendations	
		(in)	(mm)	(in)	(mm)		(in)	(mm)		AlfaCrimp One-Piece	Two-Piece Ferrule Non-Skive
AT3KST	04	1/4	6.4	0.47	2.0	3250	1.9	48.3	0.12	B	AF1
AT3KST	06	3/8	9.5	0.61	15.4	3000	2.5	63.5	0.18	B	AF1
AT3KST	08	1/2	12.7	0.76	19.2	3000	3.5	88.9	0.25	B	AF1
AT3KST ^①	12	3/4	19.1	1.09	27.6	3500	4.7	119.4	0.53	B	AF1
AT3KST ^①	16	1	25.4	1.40	35.5	3000	6.0	152.4	0.86	B	AF1

[†] Minimum burst pressure 4-to-1 safety factor.

^① Double steel wire braid . . . all others are single wire braid.

Freight: Hydraulic Hose can be combined with other KOA products for qualifying prepaid freight orders.

Because we continually examine ways to improve our products, we reserve the right to alter specifications or discontinue products without prior notice.

TF2ST - 2SC/R16 SUPERTUFF



SUPERTUFF - TF2ST Hydraulic Hose

TF2ST – Double wire braid

Meets or exceeds EN 857 2SC
Exceeds SAE 100 R16
MSHA IC-152/7 approved flame resistance



General Applications:

High pressure service with tight bends with petroleum-based hydraulic fluids, water/glycol, water- and fire-resistant hydraulic fluids, hot oil, grease, lubricants, crude oil, fuel oils, air and water. Excellent impulse performance, exceeding 1,000,000 cycles when tested with appropriate ALFAGOMMA couplings. For air or gas application above 250 PSI (1.7 Mpa) the cover should be pin-pricked.

Construction:

Tube – Synthetic rubber, black.
Reinforcement – Two high tensile steel wire braids, separated by a layer of synthetic rubber.
Cover – Synthetic rubber, black... weather, oil, fuel, ozone and excellent abrasion-resistant.

Service Temperature Range:

-40°F (-40°C) to +212°F (+100°C) constant operation.

Maximum operating temperature:

+257°F (+125°C)

Air maximum temperature: +160°F (+70°C)

Note: Operating temperatures in excess of +212°F (+100°C) may materially reduce the life of the hose.

Branding:

ALFAGOMMA FLEXOPAK 2 SUPERTUFF ID ... WP ... MPa (...PSI) – EXCEEDS SAE 100 R16 – EN 857 2SC ...DN ... MSHA IC-152/7 ...Q/YR

Nominal Specifications

Series Number	Size Code	ID		OD		Max. Working Pressure (psi)	Min. Bend. Radius		Weight (lbs/ft)	Coupling Recommendations	
		(in)	(mm)	(in)	(mm)		(in)	(mm)		AlfaCrimp One-Piece	Two-Piece Ferrule Non-Skive
TF2ST	04	1/4	6.4	0.51	13.0	6000	2.0	50.8	0.19	B	AF1
TF2ST	06	3/8	9.5	0.66	16.8	5000	2.5	63.5	0.27	B	AF1
TF2ST	08	1/2	12.7	0.81	20.6	4500	3.5	88.9	0.35	B	AF1
TF2ST	10	5/8	15.9	0.92	23.4	4000	3.9	99.1	0.41	B	AF1
TF2ST	12	3/4	19.1	1.09	27.6	3500	4.7	119.4	0.55	B	AF1
TF2ST	16	1	25.4	1.40	35.5	3000	5.9	149.9	0.82	B	AF1

† Minimum burst pressure 4-to-1 safety factor.

Freight: Hydraulic Hose can be combined with other KOA products for qualifying prepaid freight orders.

Because we continually examine ways to improve our products, we reserve the right to alter specifications or discontinue products without prior notice.



HOSES

ONE-PIECE B SERIES

ONE-PIECE D SERIES

ONE-PIECE F & P SERIES

TWO-PIECE FERRULES (A & PFR SERIES)

TWO-PIECE INSERTS (A SERIES)

TWO-PIECE INTERLOCK FERRULES & INSERTS (X & Z SERIES)

QUICK RELEASE

ASSEMBLY EQUIPMENT

TECHNICAL INFORMATION

Alfabiotech 5000 SUPERTUFF - ABT5KST Hydraulic Hose



ABT5KST - 4 or 6 wire spiral

Exceeds EN856 4SP sizes 5/8", 3/4" and 1"

Exceeds EN856 4SH sizes 1 1/4"

Exceeds SAE 100R13 sizes 1 1/2" and 2"

ISO 18752/CC 1,000,000+ impulse cycles all sizes

MSHA IC-152/7 approved flame resistance



General Applications:

Developed to withstand very demanding conditions very high performance in pressure, pulsing and flexing.

Construction:

Tube – Oil resistant synthetic rubber and biodegradable hydraulic fluids.

Reinforcement – Four/six high tensile steel spirals.

Cover – Abrasion, ozone and hydrocarbon resistant synthetic rubber: Special "SUPERTUFF" cover for excellent abrasion resistance and long service life in heavy duty applications.

Service Temperature Range:

-40°F (-40°C) to +250°F (+121°C)

Branding:

ALFAGOMMA ALFABIOTECH 5K SUPERTUFF ... WP 35 MPa (5000 PSI) - ISO 18752/CC - MSHA IC-152/7 - MADE IN ITALY

Length:

Random up to 1" - 200 feet from 1 1/4" to 2"

Nominal Specifications

Series Number	Size Code	ID		OD		Max Working† Pressure (psi)	Min. Bend. Radius		Weight (lbs/ft)	Coupling Recommendations		
		(in)	(mm)	(in)	(mm)		(in)	(mm)		AlfaCrimp One-Piece	Two-Piece	
											Ferrule Skive	Ferrule Interlock
ABT5KST	10	5/8	15.9	1.04	26.3	5000	5.5	139.7	0.63		AS4	XF2
ABT5KST	12	3/4	19.1	1.24	31.6	5000	5.9	149.9	0.87	F	AS4	XF2
ABT5KST	16	1	25.4	1.50	38.2	5000	7.1	180.3	1.14	F	AS4	XF2
ABT5KST	20	1 1/4	31.8	1.75	44.4	5000	11.0	279.4	2.00	F		XF2
ABT5KST	24	1 1/2	38.1	2.22	56.5	5000	18.7	474.9	3.09	F		XF1
ABT5KST	32	2	50.8	2.76	70.2	5000	21.5	546.1	4.28	F		XF1

† Minimum burst pressure 4-to-1 safety factor.

Freight: Hydraulic Hose can be combined with other KOA products for qualifying prepaid freight orders.

Because we continually examine ways to improve our products, we reserve the right to alter specifications or discontinue products without prior notice.

ABT6KST - Alfabiotech 6000 SUPERTUFF



HOSES
ONE-PIECE B SERIES
ONE-PIECE D SERIES
ONE-PIECE F & P SERIES
TWO-PIECE FERRULES (A & PFR SERIES)
TWO-PIECE INSERTS (A SERIES)
TWO-PIECE INTERLOCK FERRULES & INSERTS (X & Z SERIES)
QUICK RELEASE
ASSEMBLY EQUIPMENT

Alfabiotech 6000 SUPERTUFF - ABT6KST Hydraulic Hose

ABT6KST - 4 or 6 wire spiral

Exceeds EN856 4SP sizes 1/4", 3/8" and 1/2"

Exceeds EN856 4SH sizes 3/4" and 1"

Exceeds SAE 100R15 sizes 1" through 2"

ISO 18752/CC 1,000,000+ impulse cycles all sizes

MSHA IC-152/7 approved flame resistance



General Applications:

Developed to withstand very demanding conditions very high performance in pressure, pulsing and flexing.

Construction:

Tube – Oil resistant synthetic rubber and biodegradable hydraulic fluids.

Reinforcement – Four/six high tensile steel spirals (4S/6S).

Cover – Abrasion, ozone and hydrocarbon resistant synthetic rubber: Special "SUPERTUFF"

cover for excellent abrasion resistance and long service life in heavy duty applications.

Service Temperature Range:
-40°F (-40°C) to +250°F (+121°C)

Branding:

ALFAGOMMA ALFABIOTECH 6K SUPERTUFF ... WP 45 MPa (6550 PSI) - ISO 18752/CC-MSHA IC- 152/7 - MADE IN ITALY

Length:

Random up to 1" - 100 feet from 1 1/4" to 1 1/2"

Nominal Specifications

Series Number	Size Code	ID		OD		Max Working† Pressure (psi)	Min. Bend. Radius		Weight (lbs/ft)	Coupling Recommendations			
		(in)	(mm)	(in)	(mm)		(in)	(mm)		AlfaCrimp One-Piece	Two-Piece		
										Ferrule Skive	Ferrule Interlock		
ABT6KST	4	1/4	6.4	0.68	17.3	6550	2.4	61.0	0.37		AS4		
ABT6KST	6	3/8	9.5	0.79	20.1	6450	3.0	76.2	0.42		AS4		
ABT6KST	8	1/2	12.7	0.91	23.0	6000	3.5	88.9	0.51		AS4		XF2
ABT6KST	10	5/8	15.9	1.11	28.2	6000	7.1	180.3	0.81				XF1
ABT6KST	12	3/4	19.1	1.24	31.4	6000	8.2	208.3	0.97	F			XF2
ABT6KST	16	1	25.4	1.50	38.2	6000	9.8	248.9	1.32	F			XF2
ABT6KST	20	1 1/4	31.8	1.94	49.3	6000	17.5	444.5	2.29	F			XF1
ABT6KST	24	1 1/2	38.1	2.22	56.5	6000	20.8	528.3	3.02				XF1
ABT6KST	32	2	50.8	2.80	71.0	6000	25.5	647.7	4.37				ZF1

† Minimum burst pressure 4-to-1 safety factor.

Freight: Hydraulic Hose can be combined with other KOA products for qualifying prepaid freight orders.

Because we continually examine ways to improve our products, we reserve the right to alter specifications or discontinue products without prior notice.



TECHNICAL INFORMATION

HOSES
 ONE-PIECE B SERIES
 ONE-PIECE D SERIES
 ONE-PIECE F & P SERIES
 TWO-PIECE FERRULES (A & PFR SERIES)
 TWO-PIECE INSERTS (A SERIES)
 TWO-PIECE INTERLOCK FERRULES & INSERTS (X & Z SERIES)
 QUICK RELEASE
 ASSEMBLY EQUIPMENT



Single wire braid TEMP TECH 1SN
 Meets or exceeds SAE 100R1AT - EN 853 1SN



Double wire braid TEMP TECH 2SN
 Meets or exceeds SAE 100R2AT - EN 853 2SN

Like any other product, hydraulic hose is only as good as the material from which it is made. Up until now, progress in improving the service life of hydraulic hose at elevated temperatures has been extremely slow. Although there have been major advances in reinforcing techniques and materials, a major drawback has been the lack of availability of a superior elastomer that combines high retention of physical properties at elevated temperatures and long-term resistance to degradation by the fluids used in hydraulic service.

All of this has changed with the introduction of TEMP TECH, by ALFAGOMMA. This revolutionary hydraulic hose is fabricated with an inner tube made from a new, superior elastomeric material specifically developed for use in hydraulic hoses by a team of ALFAGOMMA chemists over a number of years.

TEMP TECH hydraulic hose provides a wide variety of benefits:

Resistance to degradation – TEMP TECH withstands long exposure to nearly every type of hydraulic fluid, lubricating oil or fuel commonly used in industry today, including fire-resistant hydraulic fluids. Unlike many conventional elastomers, the chemical nature of the elastomer used in the manufacture of TEMP TECH hydraulic hose is such that physical property changes due to continuing chemical reactions of ingredients do not occur.

Reduced downtime and maintenance costs – TEMP TECH hydraulic hose’s superior performance and longer life helps minimize equipment maintenance and downtime, and improve profitability.

Longer service life – Laboratory and field tests have demonstrated that this unique hydraulic hose can outlast conventional hydraulic hose under extreme temperature and pressure conditions by as much as 500% (see sidebar).

Longer shelf life –TEMP TECH hydraulic hose resists the effects of ozone and other oxidizing agents present in the air at many industrial locations . . . property changes due to shelf aging are practically non-existent.

Reduced inventory costs – There is no need to stock hoses with an assortment of tube stocks for use with petroleum and phosphate-based fluids . . . stock only TEMP TECH hydraulic hose, with its wider diversity of fluid-resistance.

Ease of use – TEMP TECH hydraulic hose requires no special fittings for assembly. TEMP TECH uses standard crimped fittings.



ABOUT OUR LABORATORY TESTS

In laboratory tests, TEMP TECH hydraulic hose withstood 1,000,000 impulse cycles at continuous +300°F (+150°C) fluid temperature at standard SAE 100R2A – EN 853 2ST test pressures in all sizes.

It should be stressed that while certain other SAE 100R2A – EN 853 2ST hose constructions, under the same test conditions, will sometimes approach 1,000,000 cycles, the tubes of these hoses by then have become brittle and hardened. Flexing these hoses will produce cracks in the tubes.

The TEMP TECH hydraulic hose, after withstanding 1,000,000 impulse cycles at +300°F (+150°C) only gains a few points of hardness, retaining its elastic qualities.

Because we continually examine ways to improve our products, we reserve the right to alter specifications or discontinue products without prior notice.

Single wire braid high temperature hydraulic hose (Up to +300°F) – T1SNTT

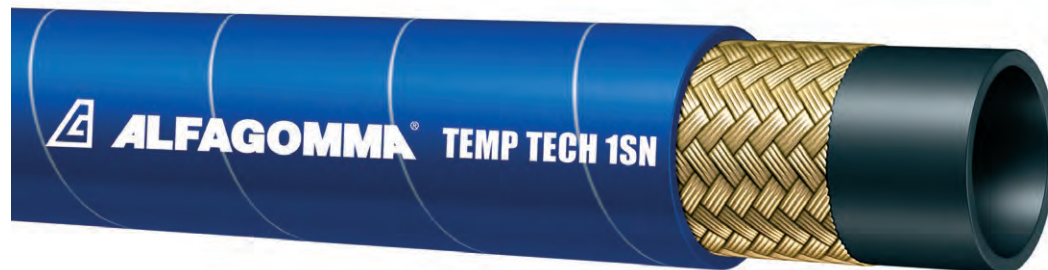

T1SNTT – Single wire braid

Meets or exceeds SAE 100 R1AT - EN 853 1SN

General Applications:

Wherever low or continuous high temperatures or fluid compatibility is a problem, this high quality, high performance hose solves the problem. Also ideal for use where greatly extended service life under "normal" conditions is desired.

Construction:

Tube – Black tube, specifically compounded for temperature and chemical resistance, oil-resistant.

Reinforcement – One high tensile steel wire braid.

Cover – Synthetic rubber, blue... weather, oil, fuel, ozone and abrasion-resistant.

Service Temperature Range:

-40°F (-40°C) to +300°F (+150°C) constant operation.

Maximum operating temperature: +300°F (+150°C)

Air maximum temperature: +250°F (+121°C)

Note: Operating temperatures in excess of +300°F (+150°C) may materially reduce the life of the hose.

Branding:

ALFAGOMMA TEMP TECH 1AT/1SN ID ... WP
...Mpa (...PSI) – SAE 100R1AT - EN 853 1SN DN
... Q/YR

Meets or exceeds the requirement of SAE J517 100R1 Type AT – EN 853 1SN

Nominal Specifications

Series Number	Size Code	ID		OD		Max. Working† Pressure (psi)	Min. Bend. Radius		Weight (lbs/ft)	Coupling Recommendations		
		(in)	(mm)	(in)	(mm)		(in)	(mm)		AlfaCrimp One-Piece	Two-Piece Ferrule Non-Skive	
T1SNTT	04	1/4	6.4	0.53	13.4	3250	3.9	099.1	0.15	B	AF1	
T1SNTT	06	3/8	9.5	0.69	17.4	2610	5.1	129.5	0.23	B	AF1	
T1SNTT	08	1/2	12.7	0.81	20.6	2320	7.1	180.3	0.29	B	AF1	
T1SNTT	12	3/4	19.1	1.09	27.7	1530	9.5	241.3	0.44	B	D	AF1
T1SNTT	16	1	25.4	1.40	35.6	1280	11.8	299.7	0.68	B	D	AF1
T1SNTT	20	1 1/4	31.8	1.71	43.5	920	16.5	419.1	0.88		D	AF1
T1SNTT	24	1 1/2	38.1	1.99	50.6	730	19.7	500.4	1.00		D	AF1
T1SNTT	32	2	50.8	2.52	64.0	600	24.8	629.1	1.35		D	AF1

† Minimum burst pressure 4-to-1 safety factor.

Note: These hoses supplied on reels.

Freight: Hydraulic Hose can be combined with other KOA products for qualifying prepaid freight orders.

Because we continually examine ways to improve our products, we reserve the right to alter specifications or discontinue products without prior notice.

T2SNTT - Temp Tech 2SN/R2AT



Double wire braid high temperature hydraulic hose (Up to +300°F) – T2SNTT

T2SNTT – Double wire braid

Meets or exceeds SAE 100 R2AT - EN 853 2SN



General Applications:

Wherever low or continuous high temperatures or fluid compatibility is a problem, this high quality, high performance hose solves the problem. Also ideal for use where greatly extended service life under "normal" conditions is desired.

Construction:

Tube – Black tube, specifically compounded for temperature and chemical resistance, oil-resistant.

Reinforcement – Two high tensile steel wire braids.

Cover – Synthetic rubber, blue... weather, oil, fuel, ozone and abrasion-resistant.

Service Temperature Range:

-40°F (-40°C) to +300°F (+150°C) constant operation.

Maximum operating temperature: +300°F (+150°C)

Air maximum temperature: +250°F (+121°C)

Note: Operating temperatures in excess of +300°F (+150°C) may materially reduce the life of the hose.

Branding:

ALFAGOMMA TEMP TECH 2AT/2SN ID ... WP ...MPa (...PSI) – SAE 100R2AT - EN 853 2SN DN ... Q/YR

Meets or exceeds the requirement of SAE J517 100R2Type AT – EN 853 2SN

Nominal Specifications

Series Number	Size Code	ID		OD		Max. Working Pressure (psi)	Min. Bend. Radius		Weight (lbs/ft)	Coupling Recommendations		
		(in)	(mm)	(in)	(mm)		(in)	(mm)		AlfaCrimp One-Piece	Two-Piece Ferrule Non-Skive	
T2SNTT	04	1/4	6.4	0.59	15.0	5850	3.9	099.1	0.25	B	AF2	
T2SNTT	06	3/8	9.5	0.75	19.1	4800	4.9	124.5	0.35	B	D	AF2
T2SNTT	08	1/2	12.7	0.87	22.2	4000	6.8	172.7	0.44		D	AF2
T2SNTT	12	3/4	19.1	1.15	29.3	3120	9.4	238.8	0.63	B	D	AF2
T2SNTT	16	1	25.4	1.50	38.1	2400	11.8	299.7	0.89	B	D	AF2
T2SNTT	20	1 1/4	31.8	1.90	48.3	1820	16.5	419.1	1.30		D	AF2
T2SNTT	24	1 1/2	38.1	2.15	54.6	1310	19.6	497.8	1.62		D	AF2
T2SNTT	32	2	50.8	2.65	67.4	1200	24.8	628.9	1.99		D	AF2

† Minimum burst pressure 4-to-1 safety factor.

Note: 1/4" through 1" ID hoses supplied on reels.

Freight: Hydraulic Hose can be combined with other KOA products for qualifying prepaid freight orders.

Because we continually examine ways to improve our products, we reserve the right to alter specifications or discontinue products without prior notice.



HOSES

ONE-PIECE B SERIES

ONE-PIECE D SERIES

ONE-PIECE F & P SERIES

TWO-PIECE FERRULES (A & PFR SERIES)

TWO-PIECE INSERTS (A SERIES)

TWO-PIECE INTERLOCK FERRULES & INSERTS (X & Z SERIES)

QUICK RELEASE

ASSEMBLY EQUIPMENT

TECHNICAL INFORMATION

One-wire Braid Hydraulic Hose – TR5TT



TR5TT – One wire braid - Reinforced

Meets or exceeds SAE 100 R5

General Applications:

Medium pressure service hydraulic petroleum-based oil line in impulse applications; lube oil, diesel fuel lines and oil for Bio-diesel; applications such as air brakes, power steering, turbocharger oil supplies, tilt cab cylinders, transmission coolant, engine coolant and filtration lines. Meets or exceeds requirements of SAE 100 R5 for traditional hydraulic applications.

Construction:

Tube – Oil-resistant synthetic rubber.

Reinforcement – One high tensile steel braid.

Cover – Polyester textile braid.

Specially designed for high temperature applications.

Temperature Range:

-40°F (-40°C) to +300°F (+150°C) constant operation.

Air max T up to 5/8" = +85°C (+185°F)

Air max T over 3/4" = +110°C (+230°F)

Branding:

ALFAGOMMA FLEXOR 5 ID ...WP ...MPa (...PSI) SAE 100 R5

Nominal Specifications

Series Number	Size Code	ID		OD		Max. Working† Pressure (psi)	Min. Bend. Radius		Weight (lbs/ft)	Coupling Recommendations	
		(in)	(mm)	(in)	(mm)		(in)	(mm)		Two-Piece	
										Ferrule Non-Skive	Insert Non-Skive
TR5TT	04	3/16	4.8	0.52	13.2	3000	3.0	76.2	0.16	AFX-03	A-03XX
TR5TT	05	1/4	6.4	0.58	14.8	3000	3.4	86.4	0.19	AFX-04	A-04XX
TR5TT	06	5/16	7.9	0.68	17.3	2250	4.0	101.6	0.24	AFX-05	A-05XX
TR5TT	08	13/32	10.3	0.77	19.5	2000	4.6	116.8	0.28	AFX-06	A-06XX
TR5TT	10	1/2	12.7	0.92	23.4	1750	5.5	139.7	0.38	AFX-08	A-08XX
TR5TT	12	5/8	15.9	1.08	27.4	1500	6.5	165.1	0.46	AFX-10	A-10XX
TR5TT	16	7/8	22.2	1.24	31.4	800	7.3	185.4	0.47	AFX-12	A-14XX
TR5TT	20	1 1/8	28.6	1.50	38.1	625	9.0	228.6	0.58	AFX-16	A-18XX
TR5TT	24	1 3/8	34.9	1.75	44.5	500	10.5	266.7	0.72	AFX-20	A-22XX
TR5TT	32	1 13/16	46.0	2.22	56.4	350	13.2	335.3	0.91	AFX-32	A-29XX

† Minimum burst pressure 4-to-1 safety factor.

Freight: Hydraulic Hose can be combined with other KOA products for qualifying prepaid freight orders.

Because we continually examine ways to improve our products, we reserve the right to alter specifications or discontinue products without prior notice.

HOSES
ONE-PIECE B SERIES
ONE-PIECE D SERIES
ONE-PIECE F & P SERIES
TWO-PIECE FERRULES (A & PFR SERIES)
TWO-PIECE INSERTS (A SERIES)
TWO-PIECE INTERLOCK FERRULES & INSERTS (X & Z SERIES)
QUICK RELEASE
ASSEMBLY EQUIPMENT
TECHNICAL INFORMATION

PF151R3 Series

NEW



General Applications:

Piranhaflex™ PF151R3 Series hose is used in general purpose low pressure hydraulic applications. This hose is intended for use in common industrial hydraulic, construction, material handling and agricultural equipment applications.

Construction:

Piranhaflex™ PF151R3 Series hose consists of three individual components bonded to ensure maximum performance.

Tube – Specialty grade nylon.

Reinforcement – Braided high tensile strength fiber reinforcement.

Cover – PF151R3 Series hose has a **black** abrasion resistant polyurethane pin pricked cover.

Service Temperature Range:

-40°F (-40°C) to +200°F (+93°C) for petroleum based hydraulic fluids.

Features & Advantages:

- PF151R3 Series meets or exceeds SAE 100R3 performance and requirements.
- The cover is a specially formulated; smooth, seamless, perforated, polyurethane compound.

Packaging:

- Hoses supplied in 250 ft. reels. All reels will have no more than 2 pieces, with no piece less than 50' in length.
- All non-standard lengths are treated as a made-to-order item and will require a minimum of 5,000 ft. to manufacture.

Nominal Specifications

Series Number	Size Code	ID		OD		Max. Working† Pressure (psi)	Min. Bend. Radius		Weight (lbs/ft)	Coupling Recommendations	
		(in)	(mm)	(in)	(mm)		(in)	(mm)		Two-Piece	Ferrule Non-Skive
PF151R3	04	1/4	6.4	0.410	10.4	1500	1.50	38.1	0.05	PFR3-04	
PF151R3	05	5/16	8.1	0.520	13.2	1500	1.75	44.5	0.07	PFR3-05	
PF151R3	06	3/8	9.7	0.610	15.5	1250	2.50	63.5	0.10	PFR3-06	
PF151R3	08	1/2	13.1	0.750	19.05	1000	3.00	76.2	0.12	PFR3-08	

Freight: Hydraulic Hose can be combined with other KOA products for qualifying prepaid freight orders.

Because we continually examine ways to improve our products, we reserve the right to alter specifications or discontinue products without prior notice.



NEW

PF415CP Series

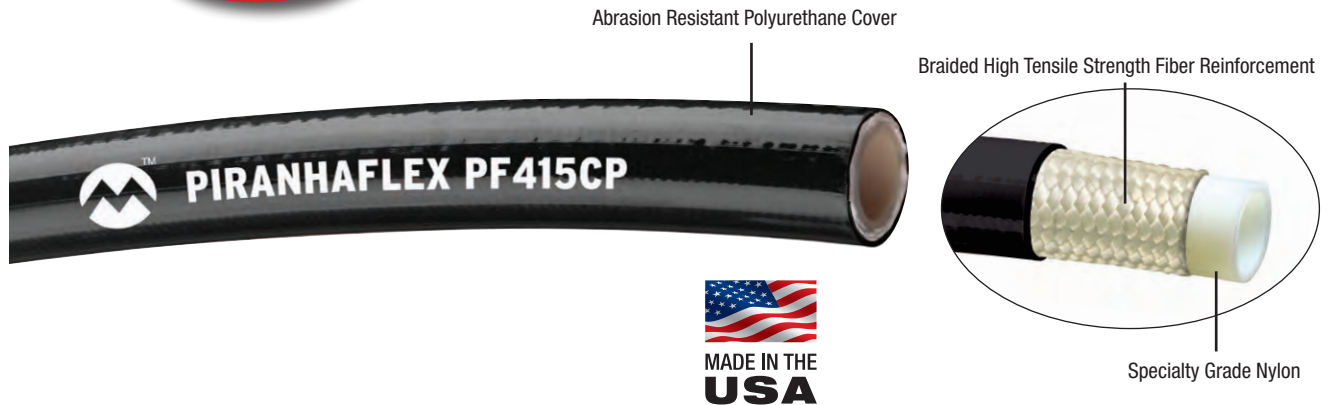

General Applications:

Piranhaflex™ PF415CP Series hose is used in general purpose low pressure hydraulic applications. This hose is intended for use in common industrial hydraulic, construction, material handling and agricultural equipment applications.

Construction:

Piranhaflex™ PF415CP Series hose consists of three individual components bonded to ensure maximum performance.

Tube – Specialty grade nylon.

Reinforcement – Braided high tensile strength fiber reinforcement.

Cover – PF415CP Series hose has a **black** abrasion resistant polyurethane pin pricked cover.

Service Temperature Range:

-40°F (-40°C) to +200°F (+93°C) for petroleum based hydraulic fluids.

Features & Advantages:

- PF415CP Series is a constant 1,500 PSI working pressure in all sizes.
- The cover is a specially formulated; smooth, seamless, perforated, polyether polyurethane compound.

Packaging:

- Hoses supplied in 250 ft. reels. All reels will have no more than 2 pieces, with no piece less than 50' in length.
- All non-standard lengths are treated as a made-to-order item and will require a minimum of 5,000 ft. to manufacture.

Nominal Specifications

Series Number	Size Code	ID		OD		Max. Working Pressure (psi)	Min. Bend. Radius		Weight (lbs/ft)	Coupling Recommendations	
		(in)	(mm)	(in)	(mm)		(in)	(mm)		Two-Piece	Ferrule Non-Skive
PF415CP	04	1/4	6.4	0.410	10.4	1500	1.50	38.1	0.05	PFR3-04	
PF415CP	05	5/16	8.1	0.520	13.2	1500	1.75	44.5	0.07	PFR3-05	
PF415CP	06	3/8	9.7	0.610	15.5	1500	2.50	63.5	0.10	PFR3-06	
PF415CP	08	1/2	13.1	0.750	19.1	1500	3.00	76.2	0.12	PFR3-08	

Freight: Hydraulic Hose can be combined with other KOA products for qualifying prepaid freight orders.

Because we continually examine ways to improve our products, we reserve the right to alter specifications or discontinue products without prior notice.



HOSES

ONE-PIECE B SERIES

ONE-PIECE D SERIES

ONE-PIECE F & P SERIES

TWO-PIECE FERRULES (A & PFR SERIES)

TWO-PIECE INSERTS (A SERIES)

TWO-PIECE INTERLOCK FERRULES & INSERTS (X & Z SERIES)

QUICK RELEASE

ASSEMBLY EQUIPMENT

TECHNICAL INFORMATION

PF354/PF354NC Series



General Applications:

Piranhaflex™ PF354 and PF354NC Series hoses (for non-conductive applications) are ideal for medium pressure hydraulic hose applications for hydraulic oil and lubrication lines.

Construction:

Piranhaflex™ PF354 & PF354NC Series hoses consist of three individual components bonded to ensure maximum performance.

Tube — Seamless nylon inner tube.

Reinforcement — Braided high tensile strength fiber reinforcement.

Cover — PF354 Series hose has a black abrasion resistant polyurethane pin picked cover; PF354NC Series hose has an Orange non-conductive (REACH Compliant), non-pin pricked abrasion resistant polyurethane cover.

Service Temperature Range:

-40°F (-40°C) to +200°F (+93°C) for petroleum based hydraulic fluids.

Features & Advantages:

- Meets or exceeds SAE J517 Standards.
- Tested at ½ bend radius under SAE Standards.
- Exceeds 100R7 impulse requirements.
- PF354NC Series hoses comply with ANSI 92.2 for Vehicle Mounted Aerial Devices.
- Light weight and flexible.
- Ideal for general hydraulic services.

Packaging:

- Hoses supplied in 250 ft. reels & 50 ft. box lengths. All reels will have no more than 2 pieces, with no piece less than 50' in length.
- All 50' boxes contain only 1 piece of hose.
- -16 MTO is available upon request.
- All non-standard lengths are treated as a made-to-order item and will require a minimum of 5,000 ft. to manufacture.
- For Twin Line please refer to page 14 for available stock sizes.

Nominal Specifications

Series Number	Size Code	ID		OD		Max. Working† Pressure (psi)	Min. Bend. Radius		Weight (lbs/ft)	Coupling Recommendations	
		(in)	(mm)	(in)	(mm)		(in)	(mm)		Two-Piece	Ferrule Non-Skive
PF354/PF354NC*	02	1/8	3.6	0.322	8.2	3000	0.75	19	0.03	* F02NPT2	
PF354/PF354NC*	03	3/16	4.8	0.415	10.5	3000	0.75	19	0.05	PFR-03	
PF354/PF354NC*	04	1/4	6.4	0.496	12.6	2750	1.50	38	0.06	PFR-04	
PF354/PF354NC*	05	5/16	8.1	0.580	14.7	2500	1.75	44	0.08	PFR7-05	
PF354/PF354NC*	06	3/8	9.7	0.650	16.5	2250	2.00	51	0.11	PFR-06	
PF354/PF354NC*	08	1/2	13.1	0.834	21.2	2000	3.00	76	0.16	PFR-08	
PF354/PF354NC	12	3/4	19.1	1.050	26.7	1250	6.00	152	0.22	PFR-12	

*Note: These ID sizes comply with ANSI 92.2 for Vehicle Mounted Aerial Devices.

† Minimum burst pressure 4-to-1 safety factor.

Freight: Hydraulic Hose can be combined with other KOA products for qualifying prepaid freight orders.

Because we continually examine ways to improve our products, we reserve the right to alter specifications or discontinue products without prior notice.

HOSES
ONE-PIECE B SERIES
ONE-PIECE D SERIES
ONE-PIECE F & P SERIES
TWO-PIECE FERRULES (A & PFR SERIES)
TWO-PIECE INSERTS (A SERIES)
TWO-PIECE INTERLOCK FERRULES & INSERTS (X & Z SERIES)
QUICK RELEASE
ASSEMBLY EQUIPMENT
TECHNICAL INFORMATION

PFP354 Series



Braided High Tensile Strength Fiber Reinforcement

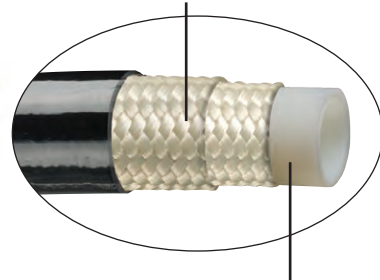

Seamless Nylon Inner Tube



General Applications:

Piranhaflex™ **Plus PFP354** Series is the ideal hose for medium pressure hydraulic lines commonly used on Fork Trucks. The “Plus” refers to the specially engineered low friction cover compound which helps in eliminating hose routing problems between hose sheaves and pulleys. Use of Piranhaflex™ **Plus** helps in extending hose service life with less frequent replacement and allows for increased flexibility and easier routing when hoses are bundled.
(-12 and -16 MTO are available upon request)

Construction:

Piranhaflex™ **PLUS PFP354** Series consists of three individual components bonded to ensure maximum performance.

Tube – Seamless nylon inner tube.

Reinforcement – Braided high tensile strength fiber reinforcement.

Cover – **PFP354** Series has a **black** abrasion resistant / special low friction polyurethane pin pricked cover.

Service Temperature Range:

-40°F (-40°C) to +200°F (+93°C) for petroleum based hydraulic fluids.

Features & Advantages:

- Meets or exceeds SAE J517 Standards.
- Tested at ½ bend radius under SAE Standards.
- Exceeds 100R7 impulse requirements
- Light weight and flexible.
- Special low friction cover eliminates hose routing problems between hose sheaves and pulleys with Fork Truck applications.

Packaging:

- Hoses supplied in 250 ft. reels.
- All reels will have no more than 2 pieces, with no piece less than 50' in length.
- All specials are treated as a made-to-order item and will require a minimum of 5,000 ft. to produce.

Nominal Specifications

Series Number	Size Code	ID		OD		Max. Working† Pressure (psi)	Min. Bend. Radius		Weight (lbs/ft)	Coupling Recommendations	
		(in)	(mm)	(in)	(mm)		(in)	(mm)		Two-Piece	
										Ferrule Non-Skive	
PFP354	04	1/4	6.4	0.496	12.6	2750	1.50	38.1	0.06	PFR-04	
PFP354	06	3/8	9.7	0.650	16.5	2250	2.00	50.8	0.11	PFR-05	
PFP354	08	1/2	13.1	0.834	21.2	2000	3.00	76.2	0.16	PFR-08	

† Minimum burst pressure 4-to-1 safety factor.

Freight: Hydraulic Hose can be combined with other KOA products for qualifying prepaid freight orders.

Because we continually examine ways to improve our products, we reserve the right to alter specifications or discontinue products without prior notice.

PFP354NC PLUS 100R7



PFP354NC Series

Braided High Tensile Strength Fiber Reinforcement

Abrasion Resistant / Special Low Friction Polyurethane Cover

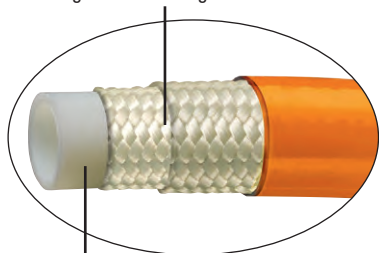

Seamless Nylon Inner Tube



General Applications:

Piranhaflex™ **PLUS** "Non-Conductive" **PFP354NC** Series is the ideal hose for medium pressure hydraulic lines commonly used on utility equipment. The "**PLUS**" refers to the specially engineered low friction cover compound which helps in eliminating hose routing problems when used with utility equipment. Use of Piranhaflex™ **PLUS** helps in extending hose service life with less frequent replacement and allows for increased flexibility and easier routing when hoses are bundled.

Construction:

Piranhaflex™ **PLUS PFP354NC** Series consists of three individual components bonded to ensure maximum performance.

Tube – Seamless nylon inner tube.

Reinforcement – Braided high tensile strength fiber reinforcement.

Cover – PFP354NC Series has an Orange non-conductive (REACH Compliant), non-pin pricked cover.

Service Temperature Range:

-40°F (-40°C) to +200°F (+93°C) for petroleum based hydraulic fluids.

Features & Advantages:

- Meets or exceeds SAE J517 Standards.
- Tested at ½ bend radius under SAE Standards.
- Exceeds 100R7 impulse requirements.
- Light weight and flexible.
- Special low friction cover eliminates hose routing problems with utility equipment applications.

Packaging:

- Hoses supplied in 250 ft. reels.
- All reels will have no more than 2 pieces, with no piece less than 50' in length.
- All specials are treated as a made-to-order item and will require a minimum of 5,000 ft. to produce.

Nominal Specifications

Series Number	Size Code	ID		OD		Max. Working† Pressure (psi)	Min. Bend. Radius		Weight (lbs/ft)	Coupling Recommendations	
		(in)	(mm)	(in)	(mm)		(in)	(mm)		Two-Piece Ferrule Non-Skive	
PFP354NC	04	1/4	6.4	0.496	12.6	2750	1.50	38.1	0.06	PFR-04	
PFP354NC	06	3/8	9.7	0.650	16.5	2250	2.00	50.8	0.11	PFR-06	
PFP354NC	08	1/2	13.1	0.834	21.2	2000	3.00	76.2	0.16	PFR-08	

† Minimum burst pressure 4-to-1 safety factor.

Freight: Hydraulic Hose can be combined with other KOA products for qualifying prepaid freight orders.

Because we continually examine ways to improve our products, we reserve the right to alter specifications or discontinue products without prior notice.



HOSES
ONE-PIECE B SERIES
ONE-PIECE D SERIES
ONE-PIECE F & P SERIES
TWO-PIECE FERRULES (A & PFR SERIES)
TWO-PIECE INSERTS (A SERIES)
TWO-PIECE INTERLOCK FERRULES & INSERTS (X & Z SERIES)
QUICK RELEASE
ASSEMBLY EQUIPMENT
TECHNICAL INFORMATION

PF367/PF367NC Series



General Applications:

Piranhaflex™ PF367 and PF367NC Series (for non-conductive applications) are ideal for medium pressure hydraulic hose applications for hydraulic oil and lubrication lines.

(-02 and -16 MTO are available upon request)

(Twin/Multi Line MTO are available upon request)

Construction:

Piranhaflex™ PF367 and PF367NC Series consist of three individual components bonded to ensure maximum performance.

Tube – Seamless polyester inner tube.

Reinforcement – Braided high tensile strength fiber reinforcement.

Cover – PF367 Series has a black abrasion resistant polyurethane pin pricked cover; PF367NC Series has an orange non-conductive (REACH Compliant), non-pin pricked cover.

Service Temperature Range:

-40°F (-40°C) to +200°F (+93°C) for petroleum based hydraulic fluids.

-40°F (-40°C) to +140°F (+60°C) for water-based and phosphate-ester based hydraulic fluids.

Features & Advantages:

- Meets or exceeds SAE J517 Standards.
- Tested at ½ bend radius under SAE Standards.
- Exceeds 100R7 impulse requirements.
- Light weight and flexible.
- Ideal for general hydraulic services.

Packaging:

- Hoses supplied in 250 ft. reels & 50 ft. box lengths.
- All reels will have no more than 2 pieces, with no piece less than 50' in length.
- All 50' boxes contain only 1 piece of hose.
- All specials are treated as a made-to-order item and will require a minimum of 5,000 ft. to produce.

Nominal Specifications

Series Number	Size Code	ID		OD		Max. Working† Pressure (psi)	Min. Bend. Radius		Weight (lbs/ft)	Coupling Recommendations	
		(in)	(mm)	(in)	(mm)		(in)	(mm)		Two-Piece	Ferrule Non-Skive
PF367/PF367NC	03	3/16	4.8	0.415	10.5	3000	0.75	19.1	0.05	PFR-03	
PF367/PF367NC	04	1/4	6.4	0.496	12.6	2750	1.50	38.1	0.06	PFR-04	
PF367/PF367NC	05	5/16	8.1	0.580	14.7	2500	1.75	44.5	0.08	PFR7-05	
PF367/PF367NC	06	3/8	9.7	0.650	16.5	2250	2.00	50.8	0.11	PFR-06	
PF367/PF367NC	08	1/2	13.1	0.834	21.2	2000	3.00	76.2	0.16	PFR-08	
PF367/PF367NC	12	3/4	19.1	1.050	26.7	1250	6.00	152.4	0.22	PFR-12	

† Minimum burst pressure 4-to-1 safety factor.

Freight: Hydraulic Hose can be combined with other KOA products for qualifying prepaid freight orders.

Because we continually examine ways to improve our products, we reserve the right to alter specifications or discontinue products without prior notice.



PF267/PF267NC Series

Braided High Tensile Strength Fiber Reinforcement

Abrasion Resistant Polyurethane Cover

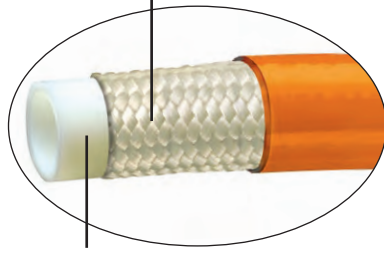

Seamless Polyester Inner Tube



General Applications:

Piranhaflex™ **PF267** and **PF267NC** Series (for nonconductive applications) are ideal for medium pressure hydraulic hose applications for hydraulic oil and lubrication lines.

(-02 and -16 MTO are available upon request)
(Twin/Multi Line MTO are available upon request)

Construction:

Piranhaflex™ **PF267** and **PF267NC** Series consist of three individual components bonded to ensure maximum performance.

Tube – Seamless polyester inner tube.

Reinforcement – Braided high tensile strength fiber reinforcement.

Cover – **PF267** Series has a **black** abrasion resistant polyurethane pin picked cover; **PF267NC Series has an Orange non-conductive (REACH Compliant), non-pin pricked cover.**

Service Temperature Range:

-40°F (-40°C) to +200°F (+93°C) for petroleum based hydraulic fluids.

-40°F (-40°C) to +140°F (+60°C) for water-based and phosphate-ester based hydraulic fluids.

Features & Advantages:

- Meets or exceeds SAE J517 Standards.
- Improved flexural rigidity, up to 16% less force to bend vs competitive 100R7 type hoses.
- Light weight and flexible.
- Improved kink resistance, up to 53% more force required to reach kink initiation vs competitive 100R7 type hose styles.
- **PF267NC Series hoses comply with ANSI 92.2 for Vehicle Mounted Aerial Devices.**
- This new hose construction facilitates installation in very tight areas.

Packaging:

- Hoses supplied in 250 ft. reel lengths.
- All reels will have no more than 2 pieces, with no piece less than 50' in length.
- All 50' boxes contain only 1 piece of hose.
- All specials are treated as a made-to-order item and will require a minimum of 5,000 ft. to produce.

Nominal Specifications

Series Number	Size Code	ID		OD		Max. Working† Pressure (psi)	Min. Bend. Radius		Weight (lbs/ft)	Coupling Recommendations	
		(in)	(mm)	(in)	(mm)		(in)	(mm)		Two-Piece	Ferrule Non-Skive
PF267/ PF267NC*	03	3/16	4.8	0.415	10.5	3000	0.75	19.1	0.05	PFR-03	
PF267/ PF267NC*	04	1/4	6.4	0.496	12.6	2750	1.50	38.1	0.07	PFR-04	
PF267/ PF267NC*	05	5/16	8.1	0.580	14.7	2500	1.75	44.5	0.09	PFR7-05	
PF267/ PF267NC*	06	3/8	9.7	0.651	16.5	2250	2.00	50.8	0.12	PFR-06	
PF267/ PF267NC*	08	1/2	13.1	0.834	21.2	2000	3.00	76.2	0.17	PFR-08	
PF267/ PF267NC	12	3/4	19.1	1.050	26.7	1250	6.00	152.4	0.24	PFR-12	

*Note: These ID sizes comply with ANSI 92.2 for Vehicle Mounted Aerial Devices.

† Minimum burst pressure 4-to-1 safety factor.

Because we continually examine ways to improve our products, we reserve the right to alter specifications or discontinue products without prior notice.



PFAN388NC Series



General Applications:

Piranhaflex™ **PFAN388NC** Series is ideal for medium pressure hydraulic lines commonly used on vehicle mounted aerial devices such as Boom Trucks and Cherry Pickers. Piranhaflex™ **PFAN388NC** Series is ideal for non-conductive medium pressure hydraulic hose applications.

Construction:

Piranhaflex™ **PFAN388NC** Series consists of three individual components bonded to ensure maximum performance.

Tube – Seamless nylon inner tube.

Reinforcement – Braided high tensile strength fiber reinforcement.

Cover – **PFAN388NC** Series has an Orange non-conductive (REACH Compliant), non-pin pricked cover.

Service Temperature Range:

-40°F (-40°C) to +200°F (+93°C) for petroleum based hydraulic fluids.

Features & Advantages:

- Meets or exceeds SAE J517 100R7 Standards.
- Tested at ½ bend radius under SAE Standards.
- Less than 50 microamperes leakage when subjected to 75,000 volts/ft. for 5 minutes.
- **PFAN388NC** Series hose complies with **ANSI 92.2 for Vehicle Mounted Aerial Devices.**
- Light weight and flexible.

Packaging:

- Hoses supplied in 250 ft. reels.
- All reels will have no more than 2 pieces, with no piece less than 50' in length.
- All specials are treated as a made-to-order item and will require a minimum of 5,000 ft. to produce.

Nominal Specifications

Series Number	Size Code	ID		OD		Max. Working† Pressure (psi)	Min. Bend. Radius		Weight (lbs/ft)	Coupling Recommendations	
		(in)	(mm)	(in)	(mm)		(in)	(mm)		Two-Piece	Ferrule Non-Skive
PFAN388NC	04	1/4	6.4	0.496	12.6	3000	1.50	38.1	0.06	PFR-04	
PFAN388NC	06	3/8	9.7	0.650	16.5	3000	2.00	50.8	0.11	PFR-06	
PFAN388NC	08	1/2	13.1	0.834	21.2	3000	3.00	76.2	0.16	PFR-08	

† Minimum burst pressure 3-to-1 safety factor.

Freight: Hydraulic Hose can be combined with other KOA products for qualifying prepaid freight orders.

Because we continually examine ways to improve our products, we reserve the right to alter specifications or discontinue products without prior notice.



PFLT364 Series- Low Temp

Braided High Tensile Strength Fiber Reinforcement

Abrasion Resistant Copolyester Cover

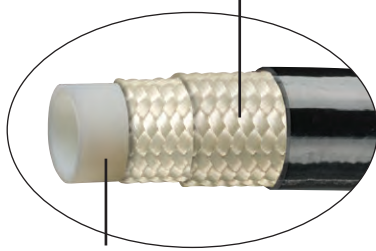

Seamless Copolyester Inner Tube



General Applications:

Piranhaflex™ PFLT364 Series is the ideal hose for medium pressure hydraulic lines commonly used on Fork Trucks to extend hose service life in cold storage applications.

Twin/Multi Line MTO are available upon request.

Construction:

Piranhaflex™ PFLT364 Series consists of three individual components bonded to ensure maximum performance.

Tube – Seamless copolyester inner tube.

Reinforcement – Braided high tensile strength fiber reinforcement.

Cover – PFLT364 Series was a **black** copolyester pin pricked cover.

Service Temperature Range:

-65°F (-65°C) to +200°F (+93°C) for petroleum based hydraulic fluids.

-65°F (-65°C) to +200°F (+93°C) for water-based and phosphate-ester based hydraulic fluids.

Features & Advantages:

- Meets or exceeds SAE J517 & J343 Standards.
- Tested at ½ bend radius under SAE J517 100R7 Standards.
- Exceeds SAE100R7 impulse requirements.
- Light weight and flexible.
- Improved cold temperature flexibility.
- A special copolyester inner tube and cover provides superior low temperature flexibility.

Packaging:

- Hoses supplied in 250 ft. reels.
- All reels will have no more than 2 pieces, with no piece less than 50' in length.
- All specials are treated as a made-to-order item and will require a minimum of 5,000 ft. to produce.

Nominal Specifications

Series Number	Size Code	ID		OD		Max. Working† Pressure (psi)	Min. Bend. Radius		Weight (lbs/ft)	Coupling Recommendations	
		(in)	(mm)	(in)	(mm)		(in)	(mm)		Two-Piece	Ferrule Non-Skive
PFLT364	04	1/4	6.4	0.496	12.6	2750	1.50	38.1	0.06		PFR-04
PFLT364	06	3/8	9.7	0.650	16.5	2250	2.00	50.8	0.11		PFR-06
PFLT364	08	1/2	13.1	0.834	21.2	2000	3.00	76.2	0.16		PFR-08

† Minimum burst pressure 4-to-1 safety factor.

Freight: Hydraulic Hose can be combined with other KOA products for qualifying prepaid freight orders.

Because we continually examine ways to improve our products, we reserve the right to alter specifications or discontinue products without prior notice.

HOSES
ONE-PIECE B SERIES
ONE-PIECE D SERIES
ONE-PIECE F & P SERIES
TWO-PIECE FERRULES (A & PFR SERIES)
TWO-PIECE INSERTS (A SERIES)
TWO-PIECE INTERLOCK FERRULES & INSERTS (X & Z SERIES)
QUICK RELEASE
ASSEMBLY EQUIPMENT
TECHNICAL INFORMATION

PF628/PF628NC Series

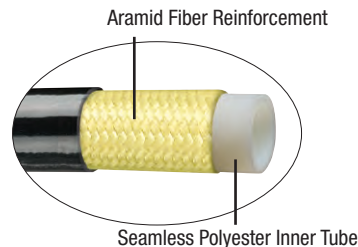

General Applications:

Piranhaflex™ PF628 Series is ideal for general purpose high pressure hydraulic applications with working pressures of 2,250 to 5,000 psi (depending on size). This hose is commonly used in industrial hydraulic construction, material handling, and agricultural equipment. Piranhaflex™ PF628NC Series has an orange, non pin-pricked cover ideal for use in applications where a non-conductive high pressure hydraulic hose is required. Typical applications include: hydraulic tools, lubrication lines and man lifts.

(-03 MTO is available upon request)

(For Twin Line please refer to page 56 for available stock sizes)

Construction:

Piranhaflex™ PF628 and PF628NC Series consist of three individual components chemically bonded to ensure maximum performance.

Tube – Extruded seamless polyester inner tube.

Reinforcement – Aramid fiber reinforcement.

Cover – PF628 Series has a **black** highly abrasion resistant polyurethane pin picked cover; PF628NC Series has an **Orange non-conductive (REACH Compliant), non-pin pricked cover.**

Service Temperature Range:

-40°F (-40°C) to +200°F (+93°C) for petroleum based hydraulic fluids.

-40°F (-40°C) to +140°F (+60°C) for water-based and phosphate-ester based hydraulic fluids.

Features & Advantages:

- Extremely durable.
- Good kink resistance.
- Lightweight-less than about half that of comparable rubber/wire hose.
- Meets or exceeds SAE 100R8 impulse requirements at half of SAE recommended bend radius standards.
- Will not swell or degrade in contact with most hydraulic fluids or oils.
- Highly abrasion resistant.
- Inner tube will not chip or peel in service, eliminating the possibility of system contamination.
- Linear change +/-3% under typical operating pressure.

Packaging:

- Hoses supplied in 250 ft. reels & 50 ft. box lengths.
- All reels will have no more than 2 pieces, with no piece less than 50' in length.
- All 50' boxes contain only 1 piece of hose.
- All specials are treated as a made-to-order item and will require a minimum of 5,000 ft. to produce.

Nominal Specifications

Series Number	Size Code	ID		OD		Max. Working Pressure (psi)	Min. Bend. Radius		Weight (lbs/ft)	Coupling Recommendations	
		(in)	(mm)	(in)	(mm)		(in)	(mm)		Two-Piece	Ferrule Non-Skive
PF628/PF628NC	04	1/4	6.4	0.485	12.3	5000	2.00	50.8	0.07		PFR-04
PF628/PF628NC	06	3/8	9.7	0.630	16.0	4000	2.50	63.5	0.10		PFR-06
PF628/PF628NC	08	1/2	13.1	0.820	20.8	3500	3.50	88.9	0.17		PFR-08
PF628/PF628NC	12	3/4	19.1	1.050	26.7	2250	4.50	114.3	0.20		PFR-12

† Minimum burst pressure 4-to-1 safety factor.

Freight: Hydraulic Hose can be combined with other KOA Products for qualifying prepaid freight orders.

Because we continually examine ways to improve our products, we reserve the right to alter specifications or discontinue products without prior notice.



PF528/PF528NC Series

Braided High Tensile Strength Fiber Reinforcement.

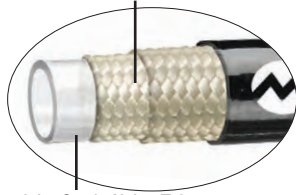

Specialty Grade Nylon Tube



Highly Abrasion Resistant Polyurethane Cover



General Applications:

Piranhaflex™ **PF528** Series is ideal for general purpose high pressure hydraulic applications with working pressures of 2,250 to 5,000 psi (depending on size). This hose is commonly used in industrial hydraulic construction, material handling, and agricultural equipment. Piranhaflex™ **PF528NC** Series has an orange, non pin-pricked cover ideal for use in applications where a non-conductive high pressure hydraulic hose is required. Typical applications include: hydraulic tools, lubrication lines and man lifts.

(-03 & -16 MTO is available upon request)

Construction:

Piranhaflex™ **PF528** and **PF528NC** Series consist of three individual components chemically bonded to ensure maximum performance.

Tube – Specialty grade nylon.

Reinforcement – Braided high tensile strength fiber reinforcement.

Cover – **PF528** Series has a **black** highly abrasion resistant polyurethane pin picked cover; **PF528NC** Series has an **Orange non-conductive (REACH Compliant), non-pin pricked cover.**

Service Temperature Range:

-40°F (-40°C) to +200°F (+93°C) for petroleum based hydraulic fluids.

-40°F (-40°C) to +140°F (+60°C) for water-based and phosphate-ester based hydraulic fluids.

Features & Advantages:

- Lightweight- less than about half that of comparable rubber/wire hose.
- Improved flexural rigidity, up to 17% less force to bend vs competitive 100R8 type hoses.
- Meets or exceeds SAE 100R8 impulse requirements at half of SAE recommended bend radius standards.
- Improved kink resistance, up to 50% more force required to reach kink initiation vs competitive 100R8 type hose styles.
- Will not swell or degrade in contact with most hydraulic fluids or oils.
- Highly abrasion resistant.
- Inner tube will not chip or peel in service, eliminating the possibility of system contamination.

Packaging:

- Hoses supplied in 250 ft. reels.
- All reels will have no more than 2 pieces, with no piece less than 50' in length.
- All specials are treated as a made-to-order item and will require a minimum of 5,000 ft. to produce.

Nominal Specifications

Series Number	Size Code	ID		OD		Max. Working† Pressure (psi)	Min. Bend. Radius		Weight (lbs/ft)	Coupling Recommendations	
		(in)	(mm)	(in)	(mm)		(in)	(mm)		Two-Piece	Ferrule Non-Skive
PF528/ PF528NC	04	1/4	6.5	0.584	14.8	5000	2.00	50	0.112	AFX-04	
PF528/ PF528NC	06	3/8	9.7	0.750	19.1	4000	2.50	64	0.154	AFX-06	
PF528/ PF528NC	08	1/2	12.9	0.935	23.7	3500	3.50	89	0.236	AFX-08	
PF528/ PF528NC	12	3/4	19.1	1.220	30.9	2250	4.50	114	0.352	AFX-12	

† Minimum burst pressure 4-to-1 safety factor.

Freight: Hydraulic Hose can be combined with other KOA products for qualifying prepaid freight orders.

Because we continually examine ways to improve our products, we reserve the right to alter specifications or discontinue products without prior notice.



HOSES
ONE-PIECE B SERIES
ONE-PIECE D SERIES
ONE-PIECE F & P SERIES
TWO-PIECE FERRULES (A & PFR SERIES)
TWO-PIECE INSERTS (A SERIES)
TWO-PIECE INTERLOCK FERRULES & INSERTS (X & Z SERIES)
QUICK RELEASE
ASSEMBLY EQUIPMENT
TECHNICAL INFORMATION

PF427/PF427NC Series



Braided High Tensile Strength Fiber Reinforcement

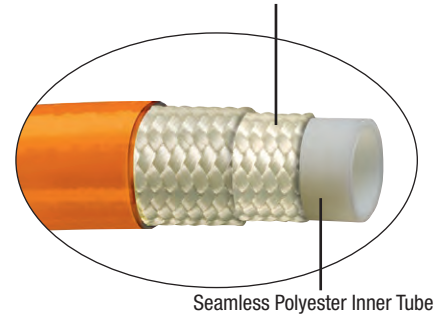

General Applications:

Piranhaflex™ Hydraulic **PF427** Series is ideal for general purpose high pressure hydraulic applications with a constant working pressure of 3,000 psi for each diameter. This hose is commonly used in industrial hydraulic construction, material handling and agricultural equipment. Piranhaflex™ Hydraulic **PF427NC** Series has an orange, non-pin pricked cover, ideal for use in applications where a non conductive, high pressure hydraulic hose is required. Typical applications include: hydraulic tools, lubrication lines and man lifts.

(Twin/Multi Line MTO and available upon request)

Construction:

Piranhaflex™ Hydraulic **PF427** and **PF427NC** Series consist of three individual components bonded to ensure maximum performance.

Tube — Seamless polyester inner tube.

Reinforcement — Braided high tensile strength fiber reinforcement.

Cover — **PF427** Series has a **black** abrasion resistant polyurethane pin pricked cover; **PF427NC** Series has an **Orange non-conductive (REACH Compliant), non-pin pricked cover.**

Service Temperature Range:

-40°F (-40°C) to +200°F (+93°C) for petroleum based hydraulic fluids.

-40°F (-40°C) to +140°F (+60°C) for water-based and phosphate-ester based hydraulic fluids.

Features & Advantages:

- Meets or exceeds SAE J517 Standards.
- Tested at ½ bend radius under SAE Standards.
- Exceeds 100R18 impulse requirements.
- Light weight and flexible.
- Ideal for general hydraulic services.

Packaging:

- Hoses supplied in 250 ft. reels.
- All reels will have no more than 2 pieces, with no piece less than 50' in length.
- All specials are treated as a made-to-order item and will require a minimum of 5,000 ft. to produce.

Nominal Specifications

Series Number	Size Code	ID		OD		Max. Working Pressure (psi)	Min. Bend. Radius		Weight (lbs/ft)	Coupling Recommendations	
		(in)	(mm)	(in)	(mm)		(in)	(mm)		Two-Piece Ferrule Non-Skive	
PF427/ PF427NC	04	1/4	6.4	0.496	12.7	3000	1.50	38.1	0.06	PFR-04	
PF427/ PF427NC	06	3/8	9.7	0.650	16.5	3000	2.00	50.8	0.11	PFR-06	
PF427/ PF427NC	08	1/2	13.1	0.834	21.1	3000	3.00	76.2	0.16	PFR-08	

† Minimum burst pressure 4-to-1 safety factor.

Freight: Hydraulic Hose can be combined with other KOA products for qualifying prepaid freight orders.

Because we continually examine ways to improve our products, we reserve the right to alter specifications or discontinue products without prior notice.

HOSES
ONE-PIECE B SERIES
ONE-PIECE D SERIES
ONE-PIECE F & P SERIES
TWO-PIECE FERRULES (A & PFR SERIES)
TWO-PIECE INSERTS (A SERIES)
TWO-PIECE INTERLOCK FERRULES & INSERTS (X & Z SERIES)
QUICK RELEASE
ASSEMBLY EQUIPMENT
TECHNICAL INFORMATION

Thermoplastic Hydraulic



PF354TL and PF354NCTL Series Twin Line Versions:

PIRANHAFLEX™ PF354TL Series Nylon Tube/Black Cover 100R7 Twin Line Hoses

Part Number	Packaging	Weight (lbs/ft)
PF354TL-04-250R	250' Reel	0.10
PF354TL-06-250R	250' Reel	0.13
PF354TL-08-200R	200' Reel	1.16

PIRANHAFLEX™ PF354NCTL Series Nylon Tube/Orange Cover Non-Conductive 100R7 Twin Line Hoses

Part Number	Packaging	Weight (lbs/ft)
PF354NCTL-04-250R	250' Reel	0.10
PF354NCTL-06-250R	250' Reel	0.13
PF354NCTL-08-200R	200' Reel	1.16

PF628TL and PF628NCTL Series Twin Line Versions:

PIRANHAFLEX™ PF628TL Series Polyester Tube/Black Cover 100R8 Twin Line Hoses

Part Number	Packaging	Weight (lbs/ft)
PF628TL-04-250R	250' Reel	0.14
PF628TL-06-250R	250' Reel	0.20
PF628TL-08-200R	200' Reel	0.34

PIRANHAFLEX™ PF628NCTL Series Polyester Tube/Orange Cover Non-Conductive 100R8 Twin Line Hoses

Part Number	Packaging	Weight (lbs/ft)
PF628NCTL-04-250R	250' Reel	0.14
PF628NCTL-06-250R	250' Reel	0.20
PF628NCTL-08-200R	200' Reel	0.34

Custom Twin and Multi Line hoses are available on request and are made to order.

For more information contact Piranha Hose Products, Inc.

Phone: (231) 779-4390 • Toll-free: (800) 250-5132 • International FAX: (231) 779-4399

Web Site: www.piranhahose.com • E-Mail: sales@piranhahose.com

Freight: Hydraulic Hose can be combined with other KOA products for qualifying prepaid freight orders.

Because we continually examine ways to improve our products, we reserve the right to alter specifications or discontinue products without prior notice.

Piranha Twin Line Process

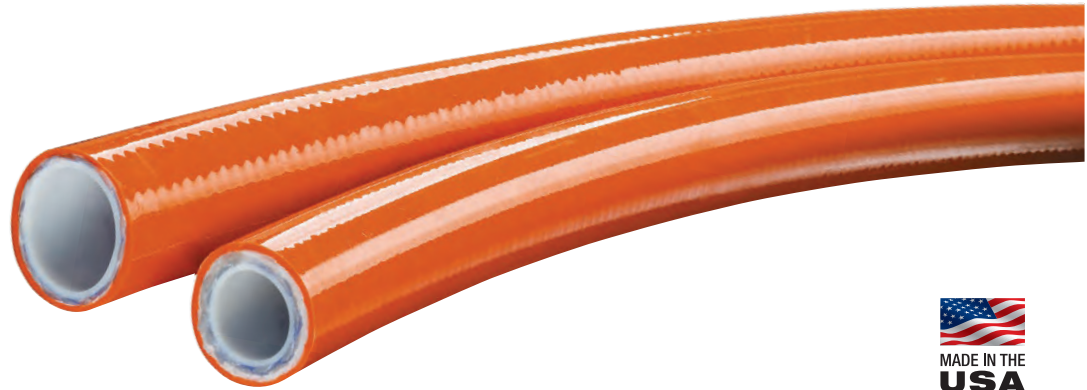

- Bonding of hose sizes from ¼" through 2" ID from available stocked hoses.
- For non-stock hose items, a minimum order of 2,500 ft. is required.
- Split-Back ends are provided; typically as lengths of 12", 18" or 24" for ease of coupling and assembly.
- Intermittent bonding can also be provided in lengths to meet your applications needs.
- Special packaging is available as required to meet your application needs.

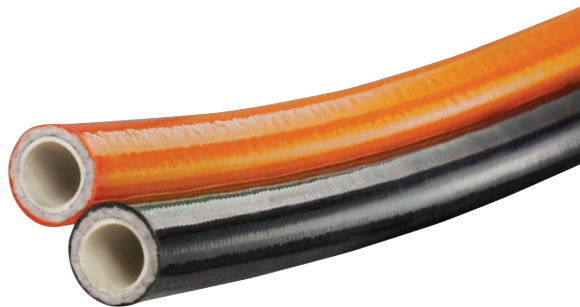

- Color coding of multi-line hose packs is available for identification and easy hook-ups.

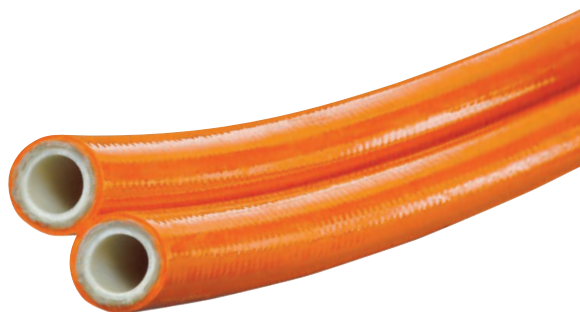

- Combinations of same or different ID's can be provided in a ribbon type configuration.

Custom Twin and Multi Line hoses are available on request and are made to order.

For more information contact Piranha Hose Products, Inc.

Phone: (231) 779-4390 • Toll-free: (800) 250-5132 • International FAX: (231) 779-4399

Web Site: www.piranhahose.com • E-Mail: sales@piranhahose.com

Because we continually examine ways to improve our products, we reserve the right to alter specifications or discontinue products without prior notice.

HOSES
ONE-PIECE B SERIES
ONE-PIECE D SERIES
ONE-PIECE F & P SERIES
TWO-PIECE FERRULES (A & PFR SERIES)
TWO-PIECE INSERTS (A SERIES)
TWO-PIECE INTERLOCK FERRULES & INSERTS (X & Z SERIES)
QUICK RELEASE
ASSEMBLY EQUIPMENT
TECHNICAL INFORMATION

PF321TC Series

Tank Charge – Compressor to tank fill hose



General Applications:

Piranhaflex™ PF321TC Series hose for use with compressed breathing air.

NOTE:

- This hose is intended for stationary applications as a fill hose for breathing air tanks.
- “NOT” for use with explosive gasses such as pure oxygen and hydrogen.
- “NOT” for use between regulator and breathing mask.

Construction:

Piranhaflex™ PF321TC Series hoses consist of three individual components bonded to ensure maximum performance.

Tube – Seamless co-polyester inner tube.

Reinforcement – Aramid fiber reinforcement.

Cover – Blue abrasion resistant (Reach Compliant) polyurethane cover.

Service Temperature Range:

-40°F (-40°C) to +150°F (+65°C)

Features & Advantages:

- Specially compounded tube minimizes extraction of particulates while in service
- Pin-pricked jacket.
- Hose complies with CGA Grade E Breathing Air Standards. Overall air quality depends on all system components.
- Blue colored cover for ease of identification. Other colors available as an MTO (made-to-order).

Packaging:

- Hoses supplied in 250 ft. reels. All reels will have no more than 2 pieces, with no piece less than 50' in length.
- All non-standard lengths are treated as a made-to-order item and will require a minimum of 5,000 ft. to manufacture.

Nominal Specifications

Series Number	Size Code	ID		OD		Max. Working Pressure (psi)	Min. Bend. Radius		Weight (lbs/ft)	Coupling Recommendations	
		(in)	(mm)	(in)	(mm)		(in)	(mm)		Two-Piece	Ferrule Non-Skive
PF321TC	03	3/16	4.8	0.400	10.2	6000	1.50	38.1	0.06		PFR-03
PF321TC	04	1/4	6.4	0.485	12.3	6000	2.00	50.8	0.07		PFR-04

Freight: Hydraulic Hose can be combined with other KOA products for qualifying prepaid freight orders.

Because we continually examine ways to improve our products, we reserve the right to alter specifications or discontinue products without prior notice.

PF344LMT Series Low Moisture Transmission Hose

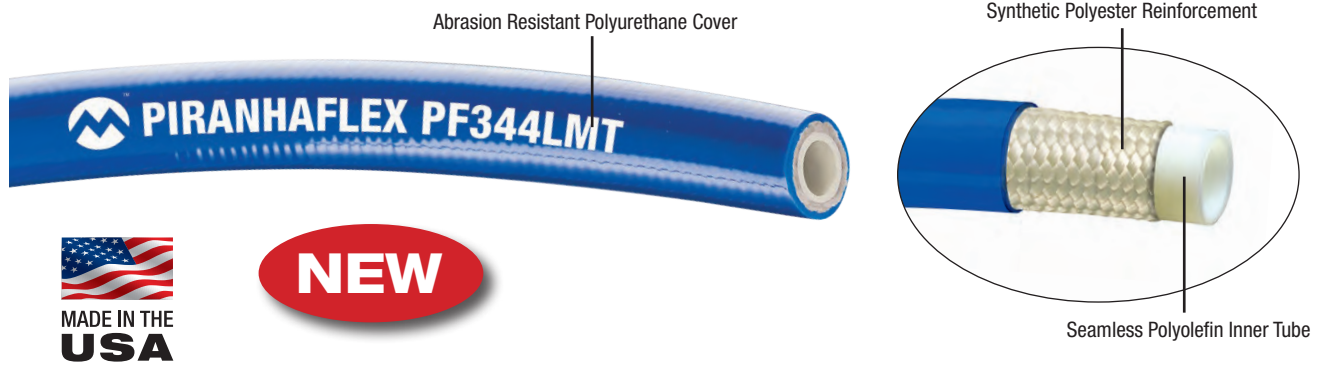

General Applications:

Piranhaflex™ PF344LMT Series hose used in low moisture transmission applications. This hose is intended for use in common industrial applications such as conveying urethane foam components, deionized water transfer, distilled water transfer and pure water transfer.

Construction:

Piranhaflex™ PF344LMT Series hoses consist of three individual components bonded to ensure maximum performance.

Tube – Seamless specialty grade polyolefin.

Reinforcement – Synthetic polyester.

Cover – Blue abrasion resistant (Reach Compliant) polyurethane cover.

Service Temperature Range:

-40°F (-40°C) to +160°F (+71°C)

Features & Advantages:

- Specially compounded tube to minimize the extraction of particulates and minimize moisture transmission.
- The cover is of specialty formulated smooth, seamless, perforated, polyurethane compound.

Packaging:

- Hoses supplied in 250 ft. reels. All reels will have no more than 2 pieces, with no piece less than 50' in length.
- All non-standard lengths are treated as a made-to-order item and will require a minimum of 5,000 ft. to manufacture.

Nominal Specifications

Series Number	Size Code	ID		OD		Max. Working Pressure (psi)	Min. Bend. Radius		Weight (lbs/ft)	Coupling Recommendations	
		(in)	(mm)	(in)	(mm)		(in)	(mm)		Two-Piece	Ferrule Non-Skive
		PF344LMT	04	1/4	6.4		.500	12.7		2750	2.5
PF344LMT	06	3/8	9.7	.650	16.5	2250	3.0	76.2	0.11	PFR-06	
PF344LMT	08	1/2	13.1	.830	21.1	2000	4.0	101.6	0.16	PFR-08	
PF344LMT	12	3/4	19.1	1.18	30.0	1500	5.0	127.0	0.28	AFX-12	
PF344LMT	16	1	25.4	1.46	37.1	1500	6.0	152.4	0.40	AFX-16	

† Minimum burst pressure 4-to-1 safety factor.

Freight: Hydraulic Hose can be combined with other KOA products for qualifying prepaid freight orders.

Because we continually examine ways to improve our products, we reserve the right to alter specifications or discontinue products without prior notice.

HOSES

ONE-PIECE B SERIES

ONE-PIECE D SERIES

ONE-PIECE F & P SERIES

TWO-PIECE FERRULES (A & PFR SERIES)

TWO-PIECE INSERTS (A SERIES)

TWO-PIECE INTERLOCK FERRULES & INSERTS (X & Z SERIES)

QUICK RELEASE

ASSEMBLY EQUIPMENT

TECHNICAL INFORMATION

Non-Conductive Braided Construction 300 PSI Push-On Hose

General Applications:

- Air tools
- Low pressure pneumatic and hydraulic systems
- Lubricating oils/diesel fuel
- Robotic welders in assembly where weld spatter is present
- Water lines in plastic molding industry

Construction:

- **Tube** – Black Nitrile – RMA Class A oil resistance.
- **Reinforcement** – Braided textile – optimum angle for push-on fitting retention.
- **Cover** – PVC/Nitrile blend, RMA Class A oil resistant and MSHA approved.

Service Temperature Range:

-30°F (-34°C) to +180°F (+82°C)

Note: For Push-On Fittings and Quick Disconnect Couplings refer to pages 15-17 of the Kuriyama Industrial Rubber Hoses Catalog.

Features and Advantages:

- **Non-Conductive** – Tested to exceed minimum electrical resistance greater than one (1) megohm per inch of hose length at 1000 volts DC.
- **MSHA approved flame resistant cover.**
- **Superior end retention** – no clamps or ferrules required when using Push-On fittings – ends remain attached at 4:1 burst pressure.
- **Easy to couple** – no tools required.
- **RMA Class “A” tube and cover oil resistance.**
- **Wide range of applications where performance and ease of assembly are demanded.**

Branding: BRAID LOCK™ NON CONDUCTIVE 300 PSI (SIZE) ID FLAME RESISTANT MSHA

Packaging: 1/4", 5/16", 3/8" and 1/2" – 500 ft., 5/8", 3/4" and 1" – 200 ft. On plastic reels, max. 3 pcs. *These are nominal reel footage quantities.

Nominal Specifications

Part Number	Color	ID (in)	OD (in)	Working Pressure (psi)	Reel Length (ft)	Weight (lbs/ft)
BL-04BK	Black	1/4	0.48	300	500	0.09
BL-04BU	Blue	1/4	0.48	300	500	0.09
BL-04GR	Green	1/4	0.48	300	500	0.09
BL-04GY	Grey	1/4	0.48	300	500	0.09
BL-04RD	Red	1/4	0.48	300	500	0.09
BL-04YL	Yellow	1/4	0.48	300	500	0.09
BL-05BK	Black	5/16	0.54	300	500	0.10
BL-06BK	Black	3/8	0.61	300	500	0.12
BL-06BU	Blue	3/8	0.61	300	500	0.12
BL-06GR	Green	3/8	0.61	300	500	0.12
BL-06GY	Grey	3/8	0.61	300	500	0.12
BL-06RD	Red	3/8	0.61	300	500	0.12
BL-06YL	Yellow	3/8	0.61	300	500	0.12
BL-08BK	Black	1/2	0.77	300	500	0.17
BL-08BU	Blue	1/2	0.77	300	500	0.17
BL-08GR	Green	1/2	0.77	300	500	0.17
BL-08GY	Grey	1/2	0.77	300	500	0.17
BL-08RD	Red	1/2	0.77	300	500	0.17
BL-08YL	Yellow	1/2	0.77	300	500	0.17
BL-10BK	Black	5/8	0.89	300	200	0.21
BL-10BU	Blue	5/8	0.89	300	200	0.21
BL-10GR	Green	5/8	0.89	300	200	0.21
BL-10GY	Grey	5/8	0.89	300	200	0.21
BL-10RD	Red	5/8	0.89	300	200	0.21
BL-10YL	Yellow	5/8	0.89	300	200	0.21
BL-12BK	Black	3/4	1.02	300	200	0.24
BL-12BU	Blue	3/4	1.02	300	200	0.24
BL-12GR	Green	3/4	1.02	300	200	0.24
BL-12GY	Grey	3/4	1.02	300	200	0.24
BL-12RD	Red	3/4	1.02	300	200	0.24
BL-12YL	Yellow	3/4	1.02	300	200	0.24
BL-16BU	Blue	1	1.31	300	200	0.33
BL-16RD	Red	1	1.31	300	200	0.33

NEW SIZE

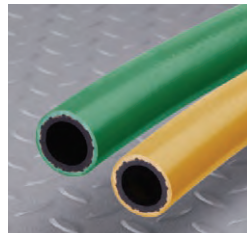
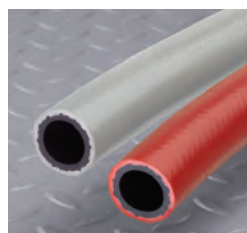

Note: Cut lengths for this product are available from our Kuriyama Schaumburg, IL Warehouse location. Please call (847) 755-0360 or e-mail: sales@kuriyama.com for more information.

Because we continually examine ways to improve our products, we reserve the right to alter specifications or discontinue products without prior notice.

TR4XF – Extra Flexible SAE 100R4 Oil Return Hose

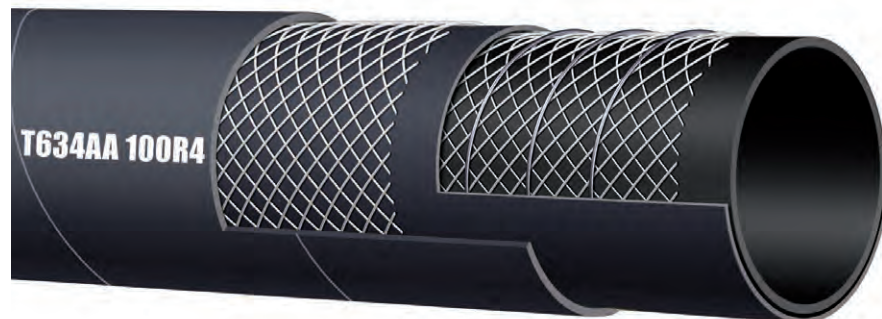

T634AA –
Textile reinforced with four spiral wire helix to prevent collapsing

Meets or exceeds SAE 100R4

General Applications:

Low pressure return lines or suction lines with half the bend radius requirements of SAE J517 100R4, service with petroleum based hydraulic fluids, water-glycol and water-fire resistant hydraulic fluids, oil, lubricants, crude oil, fuel oils and water.

Construction:

Tube – Black, conductive NBR.

Reinforcement – Textile reinforced with four spiral wire helix to prevent collapsing.

Cover – Black CR... oil, fuel, weather, ozone and abrasion-resistant.

Service Temperature Range:

-40°F (-40°C) to +212°F (+100°C) constant operation.

Maximum operating temperature:

+257°F (+125°C)

Air maximum temperature: +175°F (+80°C)

Note: Operating temperatures in excess of +212°F (+100°C) may materially reduce the life of the hose.

Branding:

ALFAGOMMA – Italy – T634 (psi) - SAE 100R4 - (SIZE) - Date

Nominal Specifications

Series Number	Size Code	ID		OD		Max. Working† Pressure (psi)	Min. Bend. Radius		Weight (lbs/ft)	Coupling Recommendations	
		(in)	(mm)	(in)	(mm)		(in)	(mm)		Two-Piece Ferrule Non-Skive	
TR4XF	12	3/4	19.1	1.18	30.0	300	1.5	38.1	0.41	AFX	
TR4XF	16	1	25.4	1.42	36.0	250	2.0	50.8	0.51	AFX	
TR4XF	20	1 1/4	31.8	1.69	43.0	200	2.5	63.5	0.62	AFX	
TR4XF	24	1 1/2	38.1	1.93	49.0	150	3.0	76.2	0.72	AFX	
TR4XF	32	2	50.8	2.44	62.0	100	4.0	101.6	0.93	AFX	
TR4XF	40	2 1/2	63.0	2.99	76.0	60	4.9	125.0	1.47		
TR4XF	48	3	76.0	3.50	89.0	60	5.9	152.0	1.75		

Note: For sizes larger than 2", please refer to Kuriyama's Industrial Rubber Hose catalog, Type T605AA.

† Minimum burst pressure 4-to-1 safety factor.

Freight: Hydraulic Hose can be combined with other KOA products for qualifying prepaid freight orders.

Because we continually examine ways to improve our products, we reserve the right to alter specifications or discontinue products without prior notice.

One-wire braid hydraulic hose – TR5



TR5 – One-wire braid-reinforced

Meets or exceeds
SAE 100 R5
SAE J1402 DOT All
FM VSS 106

General Applications:

Medium pressure service hydraulic petroleum-based oil line in impulse applications; lube oil, diesel fuel lines and oil for Bio-diesel; applications such as air brakes, power steering, turbocharger oil supplies, tilt cab cylinders, transmission coolant, engine coolant and filtration lines. Meets or exceeds requirements of SAE 100 R5 for traditional hydraulic applications.

Construction:

Tube – Oil-resistant synthetic rubber.
Reinforcement – One high tensile steel braid.
Cover – Polyester textile braid.

Service Temperature Range:

-40°F (-40°C) to +212°F (+100°C) constant operation.

Air maximum temperature: +160°F (+70°C)

Branding:

ALFAGOMMA FLEXOR 5 ID ...WP ...MPa (...PSI) SAE 100 R5*

Nominal Specifications

Series Number	Size Code	ID		OD		Max. Working† Pressure (psi)	Min. Bend. Radius		Weight (lbs/ft)	Coupling Recommendations	
		(in)	(mm)	(in)	(mm)		(in)	(mm)		Two-Piece	
							Ferrule Non-Skive	Insert Non-Skive			
TR5	04	3/16	4.8	0.52	13.2	3000	3.0	76.2	0.16	AFX-03	A-03XX
TR5	05	1/4	6.4	0.58	14.8	3000	3.4	86.4	0.19	AFX-04	A-04XX
TR5	06	5/16	7.9	0.68	17.3	2250	4.0	101.6	0.24	AFX-05	A-05XX
TR5	08	13/32	10.3	0.77	19.5	2000	4.6	116.8	0.28	AFX-06	A-06XX
TR5	10	1/2	12.7	0.92	23.4	1750	5.5	149.7	0.38	AFX-08	A-08XX
TR5	12	5/8	15.9	1.08	27.4	1500	6.5	165.1	0.46	AFX-10	A-10XX
TR5	16	7/8	22.2	1.24	31.4	800	7.3	185.4	0.47	AFX-12	A-14XX
TR5	20	1 1/8	28.6	1.50	38.1	625	9.0	228.6	0.58	AFX-16	A-18XX
TR5	24	1 3/8	34.9	1.75	44.5	500	10.5	266.7	0.72	AFX-20	A-22XX
TR5	32	1 13/16	46.0	2.22	56.4	350	13.2	335.3	0.91	AFX-32	A-29XX

† Minimum burst pressure 4-to-1 safety factor.

* Sizes -04 through -12 are DOT Type All approved and branded.

Note: 3/16" through 1" ID hoses supplied on reels.

Freight: Hydraulic Hose can be combined with other KOA products for qualifying prepaid freight orders.

Because we continually examine ways to improve our products, we reserve the right to alter specifications or discontinue products without prior notice.

HOSES
ONE-PIECE B SERIES
ONE-PIECE D SERIES
ONE-PIECE F & P SERIES
TWO-PIECE FERRULES (A & PFR SERIES)
TWO-PIECE INSERTS (A SERIES)
TWO-PIECE INTERLOCK FERRULES & INSERTS (X & Z SERIES)
QUICK RELEASE
ASSEMBLY EQUIPMENT
TECHNICAL INFORMATION

R14 PTFE True Bore Stainless Braid - TR14TB High Temp Hose

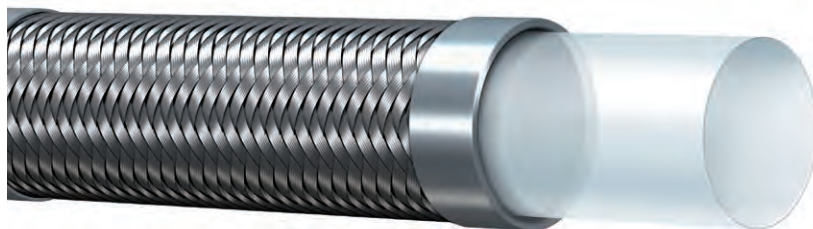

TR14TB - R14

High Tensile Stainless Steel Braid
AISI 304
FDA US Pharmacopeia - Class VI
SAE 100R14

General Applications:

Compressed air, gas, steam, fuel, oil, chemical and pharmaceutical products, particularly suitable for steam piping on injection moulding machines, diathermic oil installations, charging lines for cryogenic gas, compressor discharge lines, automotive, pharmaceutical and food sectors. Solvents, pigments and paint transfer lines. Hydraulic lines in power steering marine applications. Not suitable for molten alkali metals and halogens at high temperature.

Construction:

Tube – Smooth PTFE - high mechanical and vibration resistance, low permeability, dielectrical, fire resistant, food grade (FDA, DVGW, BFR compliant). Chemically inert, non sticking, ozone and weather resistant.

Reinforcement – High tensile stainless steel braid AISI 304.

Service Temperature Range:

-76°F (-60°C) to +500°F (+260°C) constant operation.

Nominal Specifications

Series Number	Size Code	ID		OD		Max Working [†] Pressure (psi)	Min. Bend. Radius		Weight (lbs/ft)	Coupling Recommendations	
		(in)	(mm)	(in)	(mm)		(in)	(mm)		Two-Piece Ferrule Non-Skive	
TR14TB	03	3/16	4.8	0.31	7.8	4000	2.0	50.8	0.06	AFT	
TR14TB	04	1/4	6.4	0.34	8.6	3500	3.0	76.2	0.06	AFT	
TR14TB	05	5/16	7.9	0.46	11.6	3000	4.0	101.6	0.09	AFT	
TR14TB	06	3/8	9.5	0.50	12.7	2600	5.0	127.0	0.10	AFT	
TR14TB	08	1/2	12.7	0.61	15.4	2300	5.5	139.7	0.13	AFT	
TR14TB	10	5/8	15.9	0.72	18.4	2000	6.5	165.1	0.18	AFT	
TR14TB	12	3/4	19.1	0.87	22.1	1600	8.0	203.2	0.22	AFT	
TR14TB	16	1	25.4	1.17	29.8	1000	12.0	304.8	0.35	AFT	

[†] Minimum burst pressure 4-to-1 safety factor.

Freight: Hydraulic Hose can be combined with other KOA products for qualifying prepaid freight orders.

Because we continually examine ways to improve our products, we reserve the right to alter specifications or discontinue products without prior notice.

TF2LT - 2SC/R16 LT

LOW TEMP *(Non-Stock - Made to Order)*



Double compact wire braid hydraulic hose – TF2LT



TF2LT – Double wire braid
Meets or exceeds SAE 100 R16 - EN 857 2SC

General Applications:

High pressure service hose with tight bending radius for low temperature applications with petroleum-based hydraulic fluids, water/glycol, water- and fire-resistant hydraulic fluids, hot oil, grease, lubricants, crude oil, fuel oils, air and water. Excellent impulse performance, exceeding 1,000,000 cycles when tested with appropriate ALFAGOMMA couplings. For air or gas application above 250 PSI (1.7 Mpa) the cover should be pin-pricked.

Construction:

Tube – Synthetic rubber, black... low temperature, oil-resistant.

Reinforcement – Two high tensile steel compact wire braids.

Cover – Synthetic rubber, black... weather, oil, ozone, abrasion and low temperature-resistant.

Service Temperature Range:

-58°F (-50°C) to +212°F (+100°C) constant operation.

Maximum operating temperature:

+257°F (+125°C)

Air maximum temperature: +160°F (+70°C)

Note: Operating temperatures in excess of +212°F (+100°C) may materially reduce the life of the hose.

Branding:

ALFAGOMMA FLEXOPAK 2 LT ID ...WP ...MPa (...PSI) – LOW TEMPERATURE -50°C – EXCEEDS SAE 100R16 - EN 857 2SC DN ...Q/YR

Nominal Specifications

Series Number	Size Code	ID		OD		Max. Working Pressure (psi)	Min. Bend. Radius		Weight (lbs/ft)	Coupling Recommendations	
		(in)	(mm)	(in)	(mm)		(in)	(mm)		AlfaCrimp One-Piece	Two-Piece Ferrule Non-Skive
TF2LT	04	1/4	6.4	0.51	13.0	6000	2.0	50.8	0.19	B	AF1
TF2LT	06	3/8	9.5	0.66	16.8	5000	2.5	63.5	0.27	B	AF1
TF2LT	08	1/2	12.7	0.81	20.6	4500	3.5	88.9	0.35	B	AF1
TF2LT	10	5/8	15.9	0.92	23.4	4000	3.9	99.1	0.41	B	AF1
TF2LT	12	3/4	19.1	1.09	27.6	3500	4.7	119.4	0.55	B	AF1
TF2LT	16	1	25.4	1.40	35.5	3000	5.9	149.9	0.82	B	AF1

† Minimum burst pressure 4-to-1 safety factor.

Freight: Hydraulic Hose can be combined with other KOA products for qualifying prepaid freight orders.

Because we continually examine ways to improve our products, we reserve the right to alter specifications or discontinue products without prior notice.

HOSES
ONE-PIECE B SERIES
ONE-PIECE D SERIES
ONE-PIECE F & P SERIES
TWO-PIECE FERRULES (A & PFR SERIES)
TWO-PIECE INSERTS (A SERIES)
TWO-PIECE INTERLOCK FERRULES & INSERTS (X & Z SERIES)
QUICK RELEASE
ASSEMBLY EQUIPMENT
TECHNICAL INFORMATION

Single wire braid light weight cleaning hose on easy-to-handle reels – TAJ3BK/TAJ3BU



TAJ3BK (Black) – Single wire braid



TAJ3BU (Blue) – Single wire braid

General Applications:

High pressure cleaning hose. For heavy duty use with hot and cold water and detergent fluids, and high pressure cleaning equipment. Extremely flexible, light weight and easy to handle. Use bend restrictors to extend service life.

Not recommended for steam service.

Special identification with embossed layline.

BK = Black Cover

BU = Blue Cover

Construction:

Tube – Synthetic rubber, black... hot water-resistant.

Reinforcement – High tensile steel wire braid.

Cover – Pin-pricked, synthetic rubber, black or (blue, non-marking), weather, oil and abrasion resistant.

Service Temperature Range:

-40°F (-40°C) to +300°F (+155°C) constant operation.

Maximum operating temperature: +300°F (+155°C)

Air maximum temperature: +175°F (+80°C)

Note: Operating temperatures in excess of +300°F (+155°C) may materially reduce the life of the hose.

Branding:

ALFAGOMMA ALFAJET 210 ID ...DN ... 210 Bar WP - 155°C

Nominal Specifications

Series Number	Size Code	ID		OD		Max Working Pressure (psi)	Min. Bend. Radius		Weight (lbs/ft)	Coupling Recommendations	
		(in)	(mm)	(in)	(mm)		(in)	(mm)		AlfaCrimp One-Piece	Two-Piece Ferrule Non-Skive
TAJ3BK	04	1/4	6.4	0.48	12.1	3000	1.9	48.3	0.13	B	AF1
TAJ3BK	05	5/16	7.9	0.56	14.1	3000	2.3	58.4	0.13	B	AF1
TAJ3BK	06	3/8	9.5	0.61	15.6	3000	2.5	63.5	0.19	B	AF1
TAJ3BK	08	1/2	12.7	0.77	19.5	3000	3.5	88.9	0.27	B	AF1
TAJ3BU	04	1/4	6.4	0.48	12.1	3000	1.9	48.3	0.13	B	AF1
TAJ3BU	05	5/16	7.9	0.56	14.1	3000	2.3	58.4	0.13	B	AF1
TAJ3BU	06	3/8	9.5	0.61	15.6	3000	2.5	63.5	0.19	B	AF1
TAJ3BU	08	1/2	12.7	0.77	19.5	3000	3.5	88.9	0.27	B	AF1

† Minimum burst pressure 4-to-1 safety factor.

Freight: Hydraulic Hose can be combined with other KOA products for qualifying prepaid freight orders.

Because we continually examine ways to improve our products, we reserve the right to alter specifications or discontinue products without prior notice.

TAJ5BK/BU - Alfajet 400 Pressure Washer Hose



Double wire braid light weight cleaning hose on easy-to-handle reels – TAJ5BK/TAJ5BU

TAJ5BK (Black) – Double wire braid



TAJ5BU (Blue) – Double wire braid



General Applications:

High pressure cleaning hose. For heavy duty use with hot and cold water and detergent fluids, and high pressure cleaning equipment. Extremely flexible, light weight and easy to handle. Use bend restrictors to extend service life.

Not recommended for steam service.

Special identification with embossed layline.

BK = Black Cover

BU = Blue Cover

Construction:

Tube – Synthetic rubber, black... hot water-resistant.

Reinforcement – Two high tensile steel wire braids.

Cover – Pin-pricked, synthetic rubber, black or (blue, non-marking), weather, oil, ozone and abrasion resistant.

Service Temperature Range:

-40°F (-40°C) to +300°F (+155°C) constant operation.

Maximum operating temperature:

+300°F (+155°C)

Air maximum temperature: +175°F (+80°C)

Note: Operating temperatures in excess of +300°F (+155°C) may materially reduce the life of the hose.

Branding – ALFAGOMMA ALFAJET 400 ID ... DN ... Bar WP - 155°C

Nominal Specifications

Series Number	Size Code	ID		OD		Max Working† Pressure (psi)	Min. Bend. Radius		Weight (lbs/ft)	Coupling Recommendations	
		(in)	(mm)	(in)	(mm)		(in)	(mm)		Alfacrimp One-Piece	Two-Piece Ferrule Non-Skive
TAJ5BK	04	1/4	6.4	0.52	13.2	5850	2.7	68.6	0.18	B	AF1
TAJ5BK	05	5/16	7.9	0.59	14.9	5850	3.0	76.2	0.20	B	AF1
TAJ5BK	06	3/8	9.5	0.66	16.7	5850	3.5	88.9	0.26	B	AF1
TAJ5BK	08	1/2	12.7	0.79	20.1	5850	4.5	114.3	0.34	B	AF1
TAJ5BU	04	1/4	6.4	0.52	13.2	5850	2.7	68.6	0.18	B	AF1
TAJ5BU	05	5/16	7.9	0.59	14.9	5850	3.0	76.2	0.20	B	AF1
TAJ5BU	06	3/8	9.5	0.66	16.7	5850	3.5	88.9	0.26	B	AF1
TAJ5BU	08	1/2	12.7	0.79	20.1	5850	4.5	114.3	0.34	B	AF1

† Minimum burst pressure 4-to-1 safety factor.

Freight: Hydraulic Hose can be combined with other KOA products for qualifying prepaid freight orders.

Because we continually examine ways to improve our products, we reserve the right to alter specifications or discontinue products without prior notice.



HOSES
ONE-PIECE B SERIES
ONE-PIECE D SERIES
ONE-PIECE F & P SERIES
TWO-PIECE FERRULES (A & PFR SERIES)
TWO-PIECE INSERTS (A SERIES)
TWO-PIECE INTERLOCK FERRULES & INSERTS (X & Z SERIES)
QUICK RELEASE
ASSEMBLY EQUIPMENT
TECHNICAL INFORMATION

Flexor Rig™ Slim Hole Rotary Drilling Hose



Flexor Rig™ – 6 Spirals

MSHA IC-152/16 approved flame resistance



ABT2K– 4 Spirals

MSHA IC-152/16 approved flame resistance
ISO 18752/CC 1,000,000+ impulse cycles all sizes



General Applications:

Rotary hose, specially designed for use in portable, work-over and seismograph drilling rigs.

Construction:

Tube — Oil resistant synthetic rubber.

Reinforcement — Four spiral wires for sizes -40 and -48. Six spiral wires for size -32.

Cover — Minetuff abrasion, ozone, hydrocarbon and flame resistant synthetic pin pricked rubber.

Service Temperature Range:

-40°F (-40°C) to +250°F (+121°C) constant operation.

Ambient temperature:

-40°F (-40°C) to +200°F (+100°C)

Note: Operating temperatures in excess of +250°F (+121°C) may materially reduce the life of the hose.

Branding:

ALFAGOMMA FLEXOR RIG ID – SLIM HOLE ROTARY –...WP ...MPa (...PSI) – DN – IN...MSHA IC-152/16 – Q/YR

Alfagomma Alfabiotech 2K Minetuff 2000 PSI Hydraulic Service - 3200 PSI Slim Hole Rotary Service MSHA IC-152/16 Made in Italy

Length:

100' and 200' lengths

Nominal Specifications

Series Number	Size Code	Construction	ID		OD		Max. Working Pressure (psi)	Min. Bend. Radius		Weight (lbs/ft)	Coupling Recommendations		
			(In)	(mm)	(In)	(mm)		(In)	(mm)		AlfaCrimp One-Piece	Two-Piece Interlock	
FLEXOR RIG-32	32	6 Spiral	2	50.8	2.76	70.2	5000	21.6	550	4.14	M	F	XF1
ABT2K-40	40	4 Spiral	2 1/2	63.5	3.11	79.0	3200	28.3	720	3.33			XF1
ABT2K-48	48	4 Spiral	3	76.2	3.64	92.5	3200	33.1	840	3.64			VS4 – External Skive

FLEXOR RIG † Minimum burst pressure 4-to-1 safety factor for ID size 2".

ABT2K *Note: Slim Hole Rotary Hose Working Pressure 3200 psi, Hydraulic Service 2000 psi.

† Minimum burst pressure 4-to-1 hydraulic service/2.5-to-1 slim hole rotary.

Freight: Hydraulic Hose can be combined with other KOA products for qualifying prepaid freight orders.

Because we continually examine ways to improve our products, we reserve the right to alter specifications or discontinue products without prior notice.

Flexor Rig Oilwell Cementing

NEW



AT10KOC - 6 wire spiral

MSHA IC-152/25 approved flame resistance



General Applications:

Very high pressure hydraulic lines. Also suitable for fuel oil, anti-freeze solutions, air and water. Special compact construction designed to operate at tight bend radius in demanding applications. Specially designed for oil well cementing.

Construction:

Tube – Oil resistant synthetic rubber and biodegradable hydraulic fluids.

Reinforcement – Six high tensile steel spirals.

Cover – Abrasion, ozone and hydrocarbon resistant synthetic rubber: Special “SUPERTUFF” cover for excellent abrasion resistance and long service life in heavy duty applications.

Service Temperature Range:

-40°F (-40°C) to +250°F (+121°C)

Branding:

ALFAGOMMA Flexor Rig Oilwell Cementing 10K MSHA IC- 152/25 - MADE IN ITALY

Length: 200 ft.

Note: Available with integral Fig. 1502 coupling or API threaded male extra-long hexagon fittings

Nominal Specifications

Series Number	Size Code	ID		OD		Max Working [†] Pressure (psi)	Min. Bend. Radius		Weight (lbs/ft)	Coupling Recommendations	
		(in)	(mm)	(in)	(mm)		(in)	(mm)		Two-Piece Ferrule Interlock	
AT10KOC	32	2	50.8	2.83	71.9	10000	25.5	647.7	4.37	ZF1	

[†]2.5-to-1 Minimum Burst Pressure Rating.

Freight: Hydraulic Hose can be combined with other KOA products for qualifying prepaid freight orders.

Because we continually examine ways to improve our products, we reserve the right to alter specifications or discontinue products without prior notice.

- HOSES
- ONE-PIECE B SERIES
- ONE-PIECE D SERIES
- ONE-PIECE F & P SERIES
- TWO-PIECE FERRULES (A & PFR SERIES)
- TWO-PIECE INSERTS (A SERIES)
- TWO-PIECE INTERLOCK FERRULES & INSERTS (X & Z SERIES)
- QUICK RELEASE
- ASSEMBLY EQUIPMENT
- TECHNICAL INFORMATION

WB10 - Waterblast MINETUFF



Waterblast Hose WB 10

NEW

**WB10 –
4 wire spiral**



General Applications:

High pressure water jetting

Construction:

Tube – Oil and water resistant synthetic rubber.

Reinforcement – Four high tensile steel spirals.

Cover – Oil, water and ozone resistant synthetic rubber.

Service Temperature Range:

Constant operation: +14°F (-10°C) to +158°F (+70°C)

Branding:

Dunlop Hiflex

Length:

Random length coils, all in multiples of 50 feet.

Examples: 200', 250', 300', 350'

Nominal Specifications

Series Number	Size Code	ID		OD		Max Working† Pressure (psi)	Min. Bend. Radius		Weight (lbs/ft)	Coupling Recommendations	
		(in)	(mm)	(in)	(mm)		(in)	(mm)		Two-Piece	
										Ferrule Skive	Ferrule Interlock
WB10	06	3/8	9.5	0.79	20.1	10000	6.0	152.4	0.37	AS4	
WB10	08	1/2	12.7	0.97	24.6	10000	8.0	203.2	0.54		XF2
WB10	12	3/4	19.1	1.24	31.4	10000	8.2	208.3	0.99		XF2
WB10	16	1	25.4	1.51	38.2	10000	11.0	279.4	1.37		XF2

† Minimum burst pressure: 2.5-to-1 safety factor.

Freight: Hydraulic Hose can be combined with other KOA products for qualifying prepaid freight orders.

Because we continually examine ways to improve our products, we reserve the right to alter specifications or discontinue products without prior notice.



HOSES
ONE-PIECE B SERIES
ONE-PIECE D SERIES
ONE-PIECE F & P SERIES
TWO-PIECE FERRULES (A & PFR SERIES)
TWO-PIECE INSERTS (A SERIES)
TWO-PIECE INTERLOCK FERRULES & INSERTS (X & Z SERIES)
QUICK RELEASE
ASSEMBLY EQUIPMENT
TECHNICAL INFORMATION

Waterblast Hose WB 15



NEW

**WB15 -
4 wire spiral**

General Applications:

High pressure water jetting

Construction:

- Tube** – Oil and water resistant synthetic rubber.
- Reinforcement** – Four high tensile steel spirals.
- Cover** – Oil, water and ozone resistant synthetic rubber.

Service Temperature Range:

Constant operation: +14°F (-10°C) to +158°F (+70°C)

Branding:

Dunlop Hiflex

Length:

Random length coils, all in multiples of 50 feet.
Examples: 200', 250', 300', 350'

Nominal Specifications

Series Number	Size Code	ID		OD		Max Working [†] Pressure (psi)	Min. Bend. Radius		Weight (lbs/ft)	Coupling Recommendations	
		(in)	(mm)	(in)	(mm)		(in)	(mm)		Two-Piece	
										Ferrule	Interlock
WB15	08	1/2	12.7	1.00	25.4	16000	8.0	203.2	0.75	WF9	
WB15	12	3/4	19.1	1.25	31.8	14500	11.0	279.4	1.13	WF9	

[†] Minimum burst pressure: 2.5:1 safety factor.

Freight: Hydraulic Hose can be combined with other KOA products for qualifying prepaid freight orders.

Because we continually examine ways to improve our products, we reserve the right to alter specifications or discontinue products without prior notice.

WB20 - Waterblast MINETUFF



Waterblast Hose WB 20

NEW

**WB20 –
4 wire spiral**



General Applications:

High pressure water jetting

Construction:

Tube – Oil and water resistant synthetic rubber.

Reinforcement – Four high tensile steel spirals and one steel braid.

Cover – Oil, water and ozone resistant synthetic rubber.

Service Temperature Range:

Constant operation: +14°F (-10°C) to +158°F (+70°C)

Branding:

Dunlop Hiflex

Length:

Random length coils, all in multiples of 50 feet.

Examples: 200', 250', 300', 350'

Nominal Specifications

Series Number	Size Code	ID		OD		Max Working [†] Pressure (psi)	Min. Bend. Radius		Weight (lbs/ft)	Coupling Recommendations
		(in)	(mm)	(in)	(mm)		(in)	(mm)		Two-Piece Ferrule Interlock
WB20	04	1/4	6.0	0.64	16.2	20000	4.92	125	0.41	WF9
WB20	06	3/8	10.0	0.87	22.0	20000	5.91	150	0.69	WF8
WB20	08	1/2	13.0	1.16	29.5	20000	7.87	200	0.97	WF8
WB20	12	3/4	19.0	1.38	35.0	20000	11.81	300	1.70	WF8

[†] Minimum burst pressure: 2.5-to-1 safety factor.

Freight: Hydraulic Hose can be combined with other KOA products for qualifying prepaid freight orders.

Because we continually examine ways to improve our products, we reserve the right to alter specifications or discontinue products without prior notice.



HOSES
ONE-PIECE B SERIES
ONE-PIECE D SERIES
ONE-PIECE F & P SERIES
TWO-PIECE FERRULES (A & PFR SERIES)
TWO-PIECE INSERTS (A SERIES)
TWO-PIECE INTERLOCK FERRULES & INSERTS (X & Z SERIES)
QUICK RELEASE
ASSEMBLY EQUIPMENT
TECHNICAL INFORMATION

TOP COAT

**ALFAGOMMA TOP COAT
OVER 10 TIMES HIGHER
THAN STANDARD**



TOP COAT

- ▲ **TESTED IN ACCORDANCE WITH ASTM B117-03 AND UNI ISO 9227 STANDARDS**
- ▲ **OVER 500 HOURS CORROSION PREVENTION IN SALT SPRAY FOG TO WHITE RUST**
- ▲ **MORE THAN 1000 HOURS CORROSION RESISTANCE TO RED RUST**

Resistance to red rust in salt fog
(test in compliance with ISO 9227)

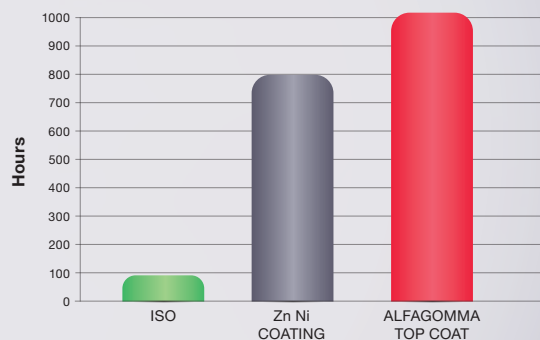

Fitting Configuration Chart



HOSES
ONE-PIECE B SERIES
ONE-PIECE D SERIES
ONE-PIECE F & P SERIES
TWO-PIECE FERRULES (A & PFR SERIES)
TWO-PIECE INSERTS (A SERIES)
TWO-PIECE INTERLOCK FERRULES & INSERTS (X & Z SERIES)
QUICK RELEASE
ASSEMBLY EQUIPMENT
TECHNICAL INFORMATION

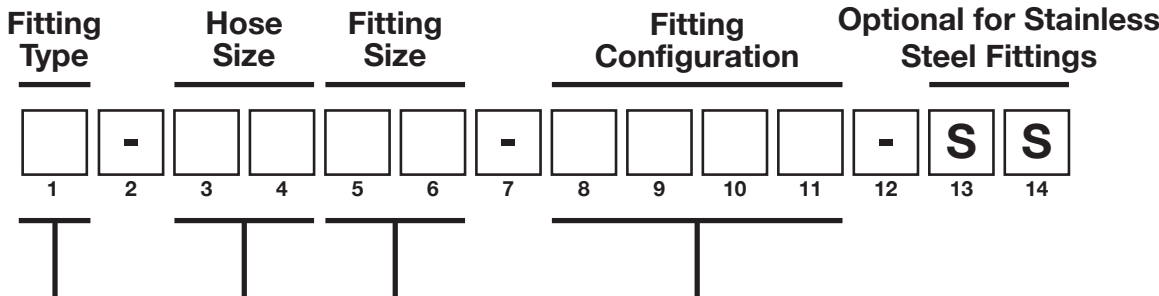

1-Piece Series	Hose Size	Fitting Size
B	-02 or 1/8"	-02 or 1/8"
D	-03 or 3/16"	-03 or 3/16"
F	-04 or 1/4"	-04 or 1/4"
P	-05 or 5/16"	-05 or 5/16"
	-06 or 3/8"	-06 or 3/8"
2-Piece Series		
A	-08 or 1/2"	-08 or 1/2"
X	-10 or 5/8"	-10 or 5/8"
Z	-12 or 3/4"	-12 or 3/4"
V	-14 or 7/8"	-14 or 7/8"
	-16 or 1"	-16 or 1"
	-20 or 1 1/4"	-20 or 1 1/4"
	-24 or 1 1/2"	-24 or 1 1/2"
	-32 or 2"	-32 or 2"
	-40 or 2 1/2"	-40 or 2 1/2"
	-48 or 3"	-48 or 3"

TYPE	SUFFIX	DESCRIPTION
NPTF	FNPR	Female National Pipe Rigid
	FPMS	Female Pipe Straight Mechanical Swivel
	FNPS	Female National Pipe Swivel
	MNPT	Male Pipe NPTF
	MNPS	Male National Pipe Swivel
	MPS9	Male Pipe Swivel 90 Degree
JIC	FJSH	Female JIC Single Hex Swivel
	FJDH	Female JIC Double Hex Swivel
	FJ45	Female JIC 45 Degree Swivel
	FJ9L	Female JIC 90 Degree Long Swivel
	FJ9M	Female JIC 90 Degree Medium Swivel
	FJ9S	Female JIC 90 Degree Short Swivel
	MJIC	Male JIC
SAE	FSAE	Female SAE Swivel
	FAE4	Female SAE 45 Degree Swivel
	FAE9	Female SAE 90 Degree Swivel
	MORB	Male O-Ring Boss
	MOBS	Male O-Ring Boss Swivel
	MBS9	Male O-Ring Boss Swivel 90 Degree
	MIFL	Male Inverted Flare
	MIF4	Male Inverted Flare 45 Degree
MIF9	Male Inverted Flare 90 Degree	
MSAE	Male SAE	
ORFS	FOFS	Female O-Ring Face Seal Swivel
	F045	Female O-Ring Face Seal 45 Degree Swivel
	F09L	Female O-Ring Face Seal 90 Degree Long Swivel
	F09M	Female O-Ring Face Seal 90 Degree Medium Swivel
	F09S	Female O-Ring Face Seal 90 Degree Short Swivel
	MOFS	Male O-Ring Face Seal
SAE Flange Code 61	C61S	Code 61 Flange Straight
	C612	Code 61 Flange 22.5 Degree
	C613	Code 61 Flange 30 Degree
	C614	Code 61 Flange 45 Degree
	C616	Code 61 Flange 60 Degree
C619	Code 61 Flange 90 Degree	
SAE Flange Code 62	C62S	Code 62 Flange Straight
	C624	Code 62 Flange 45 Degree
	C629	Code 62 Flange 90 Degree

Fitting Configuration Chart – Fitting Type Explanation

B Series – One-piece non-skive crimp fitting for all braided hoses up to 1" ID.

D Series – One-piece non-skive crimp fitting for wire braided hoses above 1" ID and 4 wire spiral hose Alfabiotech 3000 1 1/4" ID thru 2" ID and Alfabiotech 4000 3/8" ID thru 1 1/4" ID.

F Series – One-piece non-skive crimp fitting for Alfabiotech 4000 2" ID, Alfabiotech 5000 3/4" ID thru 2" ID and Alfabiotech 6000 3/4" thru 1 1/4".

P Series – One-piece non-skive crimp fitting for use with Piranhaflex™ PF321TC hose only.

A Series – Two-piece insert for all wire and textile braided hoses, thermoplastic hose, Flexor 4 and PTFE hose 3/16" thru 2" and Alfabiotech 3000 1 1/4" and 1 1/2", Alfabiotech 4000 3/8" thru 1 1/4" along with some smaller ID spiral wire reinforced hoses.

X Series – Two-piece Interlock insert for spiral wire reinforced hoses. Requires both internal and external skiving and a XF1 or XF2 Interlock ferrule to perform properly.

Z Series – Two-piece Interlock insert for Alfatech 6000 (AT6K) in 2" size only. Requires both internal and external skiving and a ZF1 Interlock ferrule to perform properly.

V Series – Two-piece insert for Flexor Rig/Alfabiotech 2000, 2 1/2" and 3" ID size only. Requires a VS4 skive ferrule to perform properly.

Because we continually examine ways to improve our products, we reserve the right to alter specifications or discontinue products without prior notice.

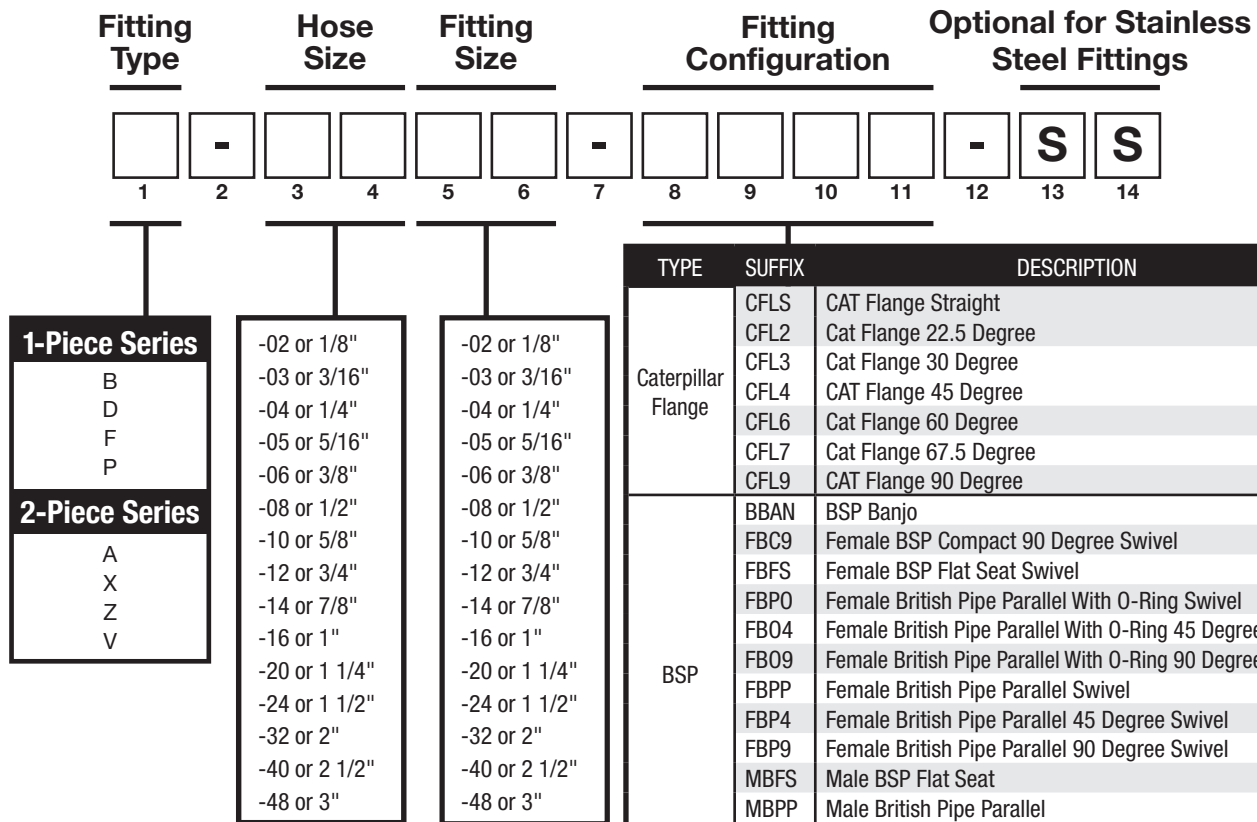

- 1-Piece Series**
- B
 - D
 - F
 - P
- 2-Piece Series**
- A
 - X
 - Z
 - V

- | | |
|---------------|---------------|
| -02 or 1/8" | -02 or 1/8" |
| -03 or 3/16" | -03 or 3/16" |
| -04 or 1/4" | -04 or 1/4" |
| -05 or 5/16" | -05 or 5/16" |
| -06 or 3/8" | -06 or 3/8" |
| -08 or 1/2" | -08 or 1/2" |
| -10 or 5/8" | -10 or 5/8" |
| -12 or 3/4" | -12 or 3/4" |
| -14 or 7/8" | -14 or 7/8" |
| -16 or 1" | -16 or 1" |
| -20 or 1 1/4" | -20 or 1 1/4" |
| -24 or 1 1/2" | -24 or 1 1/2" |
| -32 or 2" | -32 or 2" |
| -40 or 2 1/2" | -40 or 2 1/2" |
| -48 or 3" | -48 or 3" |

TYPE	SUFFIX	DESCRIPTION	
Caterpillar Flange	CFLS	CAT Flange Straight	
	CFL2	Cat Flange 22.5 Degree	
	CFL3	Cat Flange 30 Degree	
	CFL4	CAT Flange 45 Degree	
	CFL6	Cat Flange 60 Degree	
	CFL7	Cat Flange 67.5 Degree	
	CFL9	CAT Flange 90 Degree	
	BSP	BBAN	BSP Banjo
		FBC9	Female BSP Compact 90 Degree Swivel
FBFS		Female BSP Flat Seat Swivel	
FBP0		Female British Pipe Parallel With O-Ring Swivel	
FB04		Female British Pipe Parallel With O-Ring 45 Degree Swivel	
FB09		Female British Pipe Parallel With O-Ring 90 Degree Swivel	
FBPP		Female British Pipe Parallel Swivel	
FBP4		Female British Pipe Parallel 45 Degree Swivel	
FBP9		Female British Pipe Parallel 90 Degree Swivel	
MBFS		Male BSP Flat Seat	
MBPP		Male British Pipe Parallel	
MBPT		Male British Pipe Tapered/JIS	
Metric		FMFS	Female Metric French Swivel
	FMOH	Female Metric O-Ring Heavy Swivel	
	FM4H	Female Metric O-Ring 45 Degree Heavy Swivel	
	FM9H	Female Metric O-Ring 90 Degree Heavy Swivel	
	FMOL	Female Metric O-Ring Light Swivel	
	FM4L	Female Metric O-Ring 45 Degree Light Swivel	
	FM6S	Female Metric 60 Degree Seat DIN 3863	
	FM9L	Female Metric O-Ring 90 Degree Light Swivel	
	MBAN	Metric Banjo	
	MMFR	Male Metric French Solid	
	MMSH	Male Metric Solid-Heavy	
	MMSL	Male Metric Solid-Light	
	MSPS	Metric Stand Pipe Straight	
MSP4	Metric Stand Pipe 45 Degree		
MSP9	Metric Stand Pipe 90 Degree		
JIS	FJIS	Female JIS Swivel	
	FJS4	Female JIS 45 Degree Swivel	
	FJS9	Female JIS 90 Degree Swivel	
	FKOS	Female Komatsu Swivel	
	KFST	Komatsu Flange Straight	
	KF45	Komatsu Flange 45 Degree	
KF90	Komatsu Flange 90 Degree		
API	FHUN	Female Hammer Union	
	MAPI	Male API Pipe Thread	
	MHUN	Male Hammer Union	
Other	BTTF	Bite Type Tube Fitting	
	FGRT	Female Grease Tap	
	FPWS	Female Pressure Washer Swivel	
	HMEN	Hose Mender	

Fitting Configuration Chart – Fitting Type Explanation

B Series – One-piece non-skive crimp fitting for all braided hoses up to 1" ID.

D Series – One-piece non-skive crimp fitting for wire braided hoses above 1" ID and 4 wire spiral hose Alfabiotech 3000 1 1/4" ID thru 2" ID and Alfabiotech 4000 3/8" ID thru 1 1/4" ID.

F Series – One-piece non-skive crimp fitting for Alfabiotech 4000 2" ID, Alfabiotech 5000 3/4" ID thru 2" ID and Alfabiotech 6000 3/4" thru 1 1/4".

P Series – One-piece non-skive crimp fitting for use with Piranhaflex™ PF321TC hose only.

A Series – Two-piece insert for all wire and textile braided hoses, thermoplastic hose, Flexor 4 and PTFE hose 3/16" thru 2" and Alfabiotech 3000 1 1/4" and 1 1/2", Alfabiotech 4000 3/8" thru 1 1/4" along with some smaller ID spiral wire reinforced hoses.

X Series – Two-piece Interlock insert for spiral wire reinforced hoses. Requires both internal and external skiving and a XF1 or XF2 Interlock ferrule to perform properly.

Z Series – Two-piece Interlock insert for Alfatech 6000 (AT6K) in 2" size only. Requires both internal and external skiving and a ZF1 Interlock ferrule to perform properly.

V Series – Two-piece insert for Flexor Rig/Alfabiotech 2000, 2 1/2" and 3" ID size only. Requires a VS4 skive ferrule to perform properly.

Because we continually examine ways to improve our products, we reserve the right to alter specifications or discontinue products without prior notice.

Alfacrimp One-Piece Fitting Selection Chart for B, D, & F Series



- HOSES
- ONE-PIECE B SERIES
- ONE-PIECE D SERIES
- ONE-PIECE F & P SERIES
- TWO-PIECE FERRULES (A & PFR SERIES)
- TWO-PIECE INSERTS (A SERIES)
- TWO-PIECE INTERLOCK FERRULES & INSERTS (X & Z SERIES)
- QUICK RELEASE
- ASSEMBLY EQUIPMENT
- TECHNICAL INFORMATION

Hose	Page No.	Size	-04	-05	-06	-08	-10	-12	-16	-20	-24	-32	-40	-48
		DIN	6	8	10	12	16	19	25	32	38	51	63	76
		(in)	1/4	5/16	3/8	1/2	5/8	3/4	1	1 1/4	1 1/2	2	2 1/2	3
ABT3K - ALFABIOTECH 3000 MINETUFF	30									D	D	D		
ABT4K - ALFABIOTECH 4000 MINETUFF	31							D	D			F		
ABT5K - ALFABIOTECH 5000 MINETUFF	32							F	F	F	F	F		
ABT5KST - ALFABIOTECH 5000 SUPERTUFF	39							F	F	F	F	F		
ABT6K - ALFABIOTECH 6000 MINETUFF	34							F	F	F				
ABT6KST - ALFABIOTECH 6000 SUPERTUFF	40							F	F	F				
ALFAJET 210 TAJ3BK/TAJ3BU	67		B	B	B	B								
ALFAJET 400 TAJ5BK/TAJ5BU	68		B	B	B	B								
AT3KMT - ALFATECH 3000 MINETUFF	26		B	B	B	B	B	B						
AT3KST - ALFATECH 3000 SUPERTUFF	37		B		B	B		B	B					
FLEXOR RIG - SLIM HOLE ROTARY	69								F	F	F	F		
TR1MT - 1SN/R1AT MINETUFF	23		B	B	B	B	B	B			D	D	D	
TF2MT - 2SC/R16 MINETUFF	25		B	B	B	B	B	B					B	B
TF2LT - 2SC/R16 LOW TEMP	66		B		B	B	B	B						
TF2ST - 2SC/R16 SUPERTUFF	38		B		B	B	B	B						
TR2MT - 2SN/R2AT MINETUFF	24		B	B	B	B	B	B						
T1SNNTT - 1SN/R1AT TEMP TECH	43		B		B	B		B	B					
T2SNNTT - 2SN/R2AT TEMP TECH	44		B		B		B	B	B					
TF2HO - HOT OILER HOSE	70										D			





Because we continually examine ways to improve our products, we reserve the right to alter specifications or discontinue products without prior notice.









One-Piece AlfaCrimp B Series Fittings Index

HOSES
ONE-PIECE B SERIES
ONE-PIECE D SERIES
ONE-PIECE F & P SERIES
TWO-PIECE FERRULES (A & PFR SERIES)
TWO-PIECE INSERTS (A SERIES)
TWO-PIECE INTERLOCK FERRULES & INSERTS (X & Z SERIES)
QUICK RELEASE
ASSEMBLY EQUIPMENT
TECHNICAL INFORMATION

NPTF

	NPTF Male 60° Seat.....	84
	NPTF Male Swivel 60° Seat.....	85
	NPTF Female.....	86
	NPSM Female	86
	90° Compact NPTF Male Swivel 60° Seat.....	85





JIC

	JIC Male 37° Cone	89
	JIC Female 37° Seat	90
	JIC Female 37° Seat Dual Hex.....	91
	45° JIC Female 37° Seat.....	92
	90° JIC Female 37° Seat Short Drop.....	93
	90° JIC Female 37° Seat Medium Drop.....	94
	90° JIC Female 37° Seat Long Drop	95







SAE

	SAE Male O-Ring Boss	87
---	----------------------------	----



SAE (continued)

	SAE Male Swivel O-Ring Boss	87
	Bite Type Tube Fitting.....	88
	SAE Male 90° Compact Swivel O-Ring Boss	88
	SAE Female Swivel 45° Seat.....	95

ORFS

	ORFS Male	96
	ORFS Female with Stem Hexagon.....	97
	45° ORFS Female.....	98
	90° ORFS Female Short Drop.....	99
	90° ORFS Female Medium Drop	100
	90° ORFS Female Long Drop.....	100

SAE Flange Code 61

	Flange SAE 3000 PSI J518 Code 61	101
	45° Flange SAE 3000 PSI J518 Code 61	101
	90° Flange SAE 3000 PSI J518 Code 61	102

Because we continually examine ways to improve our products, we reserve the right to alter specifications or discontinue products without prior notice.

One-Piece AlfaCrimp B Series Fittings Index

SAE Flange Code 62

	Flange SAE 6000 PSI J518 Code 62.....	102
	45° Flange SAE 6000 PSI J518 Code 62.....	103
	90° Flange SAE 6000 PSI J518 Code 62.....	103

BSP

	BSPP Female 60° Cone with O-Ring.....	105
	BSPP Female Flat Seat	105
	BSPP Male Parallel 60° Flare.....	104
	BSPT/JIS Male Tapered	104
	45° BSPP Female 60° cone with O-Ring 45.....	106
	90° Compact BSPP Female 60° Cone.....	106
	90° BSPP Female 60° Cone with O-Ring	107

Metric

	Metric Straight Standpipe DIN 2353.....	107
--	--	-----

	Metric Male 24° Seat - Light DIN 3853.....	108
--	---	-----

	Metric Female 24° Cone with O-Ring - Light DIN 3865.....	108
--	---	-----

	45° Metric Female 24° Cone with O-Ring - Light DIN 3865.....	109
--	---	-----

	90° Metric Female 24° Cone with O-Ring - Light DIN 3865.....	109
--	---	-----

	Metric Male 24° Seat - Heavy DIN 3853.....	110
--	---	-----

	Metric Female 24° Cone with O-Ring - Heavy DIN 3865.....	110
--	---	-----

	45° Metric Female 24° Cone with O-Ring - Heavy DIN 3865.....	111
--	---	-----

	90° Metric Female 24° Cone with O-Ring - Heavy DIN 3865.....	111
--	---	-----

Other

	JIS Female 60° Seat Flare B 8363 (Type F).....	112
--	---	-----

	Komatsu Female.....	112
--	---------------------	-----

	Hose Mender.....	84
--	------------------	----

	Female Grease Trap	112
--	--------------------------	-----

Because we continually examine ways to improve our products, we reserve the right to alter specifications or discontinue products without prior notice.

AlfaCrimp One-Piece Fittings - B Series



HOSES
ONE-PIECE B SERIES
ONE-PIECE D SERIES
ONE-PIECE F & P SERIES
TWO-PIECE FERRULES (A & PFR SERIES)
TWO-PIECE INSERTS (A SERIES)
TWO-PIECE INTERLOCK FERRULES & INSERTS (X & Z SERIES)
QUICK RELEASE
ASSEMBLY EQUIPMENT
TECHNICAL INFORMATION

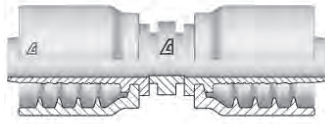

Hose Mender

Part Number	Dash Size	Hose ID Size		Weight (lbs/each)
		(in)	(mm)	
B-0404-HMEN	04	1/4	6.4	0.13
B-0505-HMEN	05	5/16	7.9	0.15
B-0606-HMEN	06	3/8	9.5	0.18
B-0808-HMEN	08	1/2	12.7	0.25
B-1010-HMEN	10	5/8	15.9	0.32
B-1212-HMEN	12	3/4	19.0	0.56
B-1616-HMEN	16	1	25.4	1.00

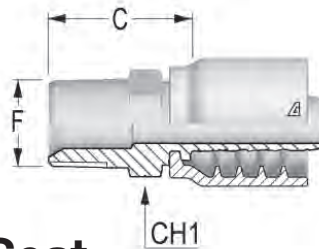

NPTF Male 60° Seat

Part Number	Dash Size	Hose ID Size		F Thread		C Cut-Off Factor (mm)	CH1 (mm)	Weight (lbs/each)
		(in)	(mm)	Dash Size	Size (in) - TPI			
B-0402-MNPT	04	1/4	6.4	02	1/8-27	21.3	14.0	0.11
B-0404-MNPT	04	1/4	6.4	04	1/4-18	26.8	14.3	0.13
B-0406-MNPT	04	1/4	6.4	06	3/8-18	27.8	19.0	0.15
B-0408-MNPT	04	1/4	6.4	08	1/2-14	31.3	22.0	0.17
B-0504-MNPT	05	5/16	7.9	04	1/4-18	26.8	17.0	0.14
B-0506-MNPT	05	5/16	7.9	06	3/8-18	27.8	19.0	0.17
B-0604-MNPT	06	3/8	9.5	04	1/4-18	26.8	17.0	0.16
B-0606-MNPT	06	3/8	9.5	06	3/8-18	27.8	19.0	0.18
B-0608-MNPT	06	3/8	9.5	08	1/2-14	31.3	22.0	0.24
B-0806-MNPT	08	1/2	12.7	06	3/8-18	28.6	19.0	0.22
B-0808-MNPT	08	1/2	12.7	08	1/2-14	32.1	22.0	0.27
B-0812-MNPT	08	1/2	12.7	12	3/4-14	34.1	27.0	0.31
B-1008-MNPT	10	5/8	15.9	08	1/2-14	33.1	24.0	0.31
B-1012-MNPT	10	5/8	15.9	12	3/4-14	34.1	27.0	0.35
B-1208-MNPT	12	3/4	19.0	08	1/2-14	33.6	27.0	0.39
B-1212-MNPT	12	3/4	19.0	12	3/4-14	34.6	27.0	0.44
B-1216-MNPT	12	3/4	19.0	16	1-11 1/2	43.6	36.0	0.63
B-1612-MNPT	16	1	25.4	12	3/4-14	44.0	27.0	0.74
B-1616-MNPT	16	1	25.4	16	1-11 1/2	44.4	36.0	0.77
B-1620-MNPT	16	1	25.4	20	1 1/4-11 1/2	47.4	46.0	1.04

Because we continually examine ways to improve our products, we reserve the right to alter specifications or discontinue products without prior notice.



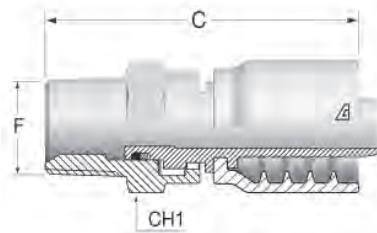

NPTF Male Swivel 60° Seat

Part Number	Dash Size	Hose ID Size		F Thread		C Cut-Off Factor (mm)	CH1 (mm)	Weight (lbs/each)
		(in)	(mm)	Dash Size	Size (in) - TPI			
B-0404-MNPS	04	1/4	6.4	04	1/4-18	37.6	17	0.16
B-0406-MNPS	04	1/4	6.4	06	3/8-18	39.5	22	0.22
B-0604-MNPS	06	3/8	9.5	04	1/4-18	39.6	17	0.18
B-0606-MNPS	06	3/8	9.5	06	3/8-18	37.5	22	0.24
B-0608-MNPS	06	3/8	9.5	08	1/2-14	43.5	25	0.30
B-0806-MNPS	08	1/2	12.7	06	3/8-18	38.3	22	0.33
B-0808-MNPS	08	1/2	12.7	08	1/2-14	42.3	25	0.59
B-1212-MNPS	12	3/4	19.0	12	3/4-14	50.1	32	0.99
B-1616-MNPS	16	1	25.4	16	1-11 1/2	57.9	41	1.06

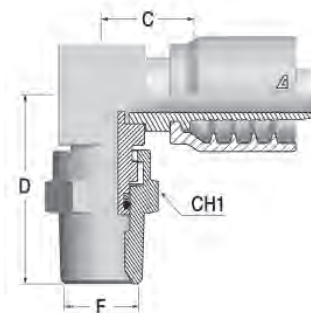

90° Compact NPTF Male Swivel 60° Seat

Part Number	Dash Size	Hose ID Size		F Thread		C Cut-Off Factor (mm)	D Drop (mm)	CH1 (mm)	Weight (lbs/each)
		(in)	(mm)	Dash Size	Size (in) - TPI				
B-0404-MPS9	04	1/4	6.4	04	1/4-18	17	39	17	0.28
B-0406-MPS9	04	1/4	6.4	06	3/8-18	19	39	22	0.34
B-0604-MPS9	06	3/8	9.5	04	1/4-18	17	41	17	0.40
B-0606-MPS9	06	3/8	9.5	06	3/8-18	20	41	22	0.50
B-0608-MPS9	06	3/8	9.5	08	1/2-14	22	41	25	0.59
B-0806-MPS9	08	1/2	12.7	06	3/8-18	23	48	22	0.70
B-0808-MPS9	08	1/2	12.7	08	1/2-14	22	48	25	0.81
B-1212-MPS9	12	3/4	19.0	12	3/4-14	27	61	32	0.90
B-1616-MPS9	16	1	25.4	16	1-11 1/2	35	70	41	1.01

Because we continually examine ways to improve our products, we reserve the right to alter specifications or discontinue products without prior notice.

AlfaCrimp One-Piece Fittings - B Series



HOSES
ONE-PIECE B SERIES
ONE-PIECE D SERIES
ONE-PIECE F & P SERIES
TWO-PIECE FERRULES (A & PFR SERIES)
TWO-PIECE INSERTS (A SERIES)
TWO-PIECE INTERLOCK FERRULES & INSERTS (X & Z SERIES)
QUICK RELEASE
ASSEMBLY EQUIPMENT
TECHNICAL INFORMATION

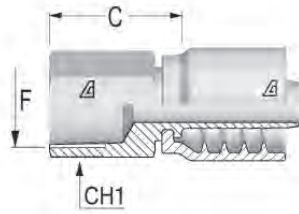

NPTF Female

Part Number	Dash Size	Hose ID Size		F Thread		C Cut-Off Factor (mm)	CH1 (mm)	Weight (lbs/each)
		(in)	(mm)	Dash Size	Size (in) - TPI			
B-0404-FNPR	04	1/4	6.4	04	1/4-18	27.8	19	0.16
B-0606-FNPR	06	3/8	9.5	06	3/8-18	28.8	22	0.20
B-0808-FNPR	08	1/2	12.7	08	1/2-14	35.6	25	0.29
B-1212-FNPR	12	3/4	19.0	12	3/4-14	38.1	32	0.48
B-1616-FNPR	16	1	25.4	16	1-11 1/2	44.9	38	0.74

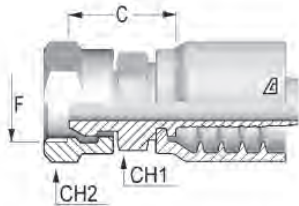

NPSM Female

Part Number	Dash Size	Hose ID Size		F Thread		C Cut-Off Factor (mm)	CH1 (mm)	CH2 (mm)	Weight (lbs/each)
		(in)	(mm)	Dash Size	Size (in) - TPI				
B-0404-FPMS	04	1/4	6.4	04	1/4-18	24.3	17	19	0.17
B-0606-FPMS	06	3/8	9.5	06	3/8-18	25.8	19	22	0.23
B-0808-FPMS	08	1/2	12.7	08	1/2-14	27.6	22	27	0.31
B-1212-FPMS	12	3/4	19.0	12	3/4-14	28.6	27	32	0.63
B-1616-FPMS	16	1	25.4	16	1-11 1/2	35.4	36	38	0.88

Because we continually examine ways to improve our products, we reserve the right to alter specifications or discontinue products without prior notice.



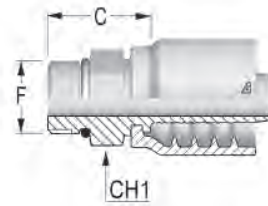

SAE Male O-Ring Boss

Part Number	Dash Size	Hose ID Size		F Thread		C Cut-Off Factor (mm)	CH1 (mm)	Weight (lbs/each)
		(in)	(mm)	Dash Size	Size (in) - TPI			
B-0404-MORB	04	1/4	6.4	04	7/16-20	20.3	14	0.11
B-0405-MORB	04	1/4	6.4	05	1/2-20	21.3	16	0.12
B-0406-MORB	04	1/4	6.4	06	9/16-18	22.3	17	0.12
B-0606-MORB	06	3/8	9.5	06	9/16-18	23.3	19	0.16
B-0608-MORB	06	3/8	9.5	08	3/4-16	24.3	22	0.19
B-0610-MORB	06	3/8	9.5	10	7/8-14	26.8	27	0.24
B-0808-MORB	08	1/2	12.7	08	3/4-16	25.1	22	0.23
B-0810-MORB	08	1/2	12.7	10	7/8-14	27.6	27	0.28
B-0812-MORB	08	1/2	12.7	12	1 1/16-12	32.1	32	0.37
B-1010-MORB	10	5/8	15.9	10	7/8-14	29.8	27	0.39
B-1012-MORB	10	5/8	15.9	12	1 1/16-12	32.1	32	0.41
B-1210-MORB	12	3/4	19.0	10	7/8-14	28.1	27	0.39
B-1212-MORB	12	3/4	19.0	12	1 1/16-12	32.6	32	0.48
B-1216-MORB	12	3/4	19.0	16	1 5/16-12	34.6	38	0.61
B-1616-MORB	16	1	25.4	16	1 5/16-12	35.4	38	0.73

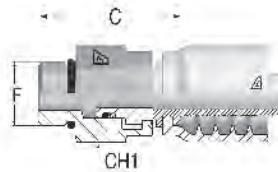

SAE Male Swivel O-Ring Boss

Part Number	Dash Size	Hose ID Size		F Thread		C Cut-Off Factor (mm)	CH1 (mm)	Weight (lbs/each)
		(in)	(mm)	Dash Size	Size (in) - TPI			
B-0404-MOBS	04	1/4	6.4	04	7/16-20	33.1	17	0.19
B-0405-MOBS	04	1/4	6.4	05	1/2-20	37.6	17	0.20
B-0406-MOBS	04	1/4	6.4	06	9/16-18	42.5	22	0.20
B-0606-MOBS	06	3/8	9.5	06	9/16-18	40.5	22	0.22
B-0608-MOBS	06	3/8	9.5	08	3/4-16	43.5	25	0.24
B-0808-MOBS	08	1/2	12.7	08	3/4-16	42.3	25	0.38
B-0810-MOBS	08	1/2	12.7	10	7/8-14	43.8	25	0.40
B-1212-MOBS	12	3/4	19.0	12	1 1/16-12	49.6	32	0.50
B-1616-MOBS	16	1	25.4	16	1 5/16-12	52.0	38	1.00

Because we continually examine ways to improve our products, we reserve the right to alter specifications or discontinue products without prior notice.

AlfaCrimp One-Piece Fittings - B Series



HOSES
ONE-PIECE B SERIES
ONE-PIECE D SERIES
ONE-PIECE F & P SERIES
TWO-PIECE FERRULES (A & PFR SERIES)
TWO-PIECE INSERTS (A SERIES)
TWO-PIECE INTERLOCK FERRULES & INSERTS (X & Z SERIES)
QUICK RELEASE
ASSEMBLY EQUIPMENT
TECHNICAL INFORMATION

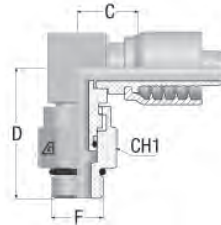

SAE Male 90° Compact Swivel O-Ring Boss

Part Number	Dash Size	Hose ID Size		F Thread		C Cut-Off Factor (mm)	D Drop (mm)	CH1 (mm)	Weight (lbs/each)
		(in)	(mm)	Dash Size	Size (in) - TPI				
B-0404-MBS9	04	1/4	6.4	04	7/16-20	17	35	17	0.22
B-0405-MBS9	04	1/4	6.4	05	1/2-20	17	35	17	0.25
B-0406-MBS9	04	1/4	6.4	06	9/16-18	19	42	22	0.26
B-0606-MBS9	06	3/8	9.5	06	9/16-18	20	44	22	0.27
B-0608-MBS9	06	3/8	9.5	08	3/4-16	22	45	25	0.30
B-0808-MBS9	08	1/2	12.7	08	3/4-16	23	48	25	0.44
B-0810-MBS9	08	1/2	12.7	10	7/8-14	23	50	25	0.48
B-1212-MBS9	12	3/4	19.0	12	1 1/16-12	27	60	32	0.60
B-1616-MBS9	16	1	25.4	16	1 5/16-12	30	64	38	1.10

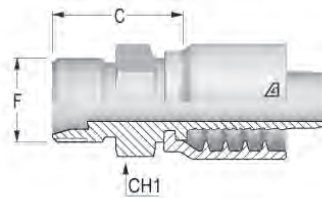

Bite Type Tube Fitting (Does Not Include Nut or Ferrule)

Part Number	Dash Size	Hose ID Size		F Thread		C Cut-Off Factor (mm)	CH1 (mm)	Weight (lbs/each)
		(in)	(mm)	Dash Size	Size (in) - TPI			
B-0404-BTTF	04	1/4	6.4	04	7/16-20	21.8	12	0.13
B-0506-BTTF	05	5/16	7.9	06	1/2-20	24.2	16	0.18
B-0606-BTTF	06	3/8	9.5	06	9/16-18	24.2	16	0.18
B-0608-BTTF	06	3/8	9.5	08	3/4-16	27.6	22	0.25
B-0808-BTTF	08	1/2	12.7	08	3/4-16	28.4	22	0.28
B-1212-BTTF	12	3/4	19.0	12	1 1/16-12	33.1	30	0.44
B-1616-BTTF	16	1	25.4	16	1 5/16-12	37.9	36	0.95

Because we continually examine ways to improve our products, we reserve the right to alter specifications or discontinue products without prior notice.



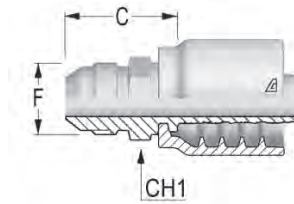

JIC Male 37° Cone

Part Number	Dash Size	Hose ID Size		F Thread		C Cut-Off Factor (mm)	CH1 (mm)	Weight (lbs/each)
		(in)	(mm)	Dash Size	Size (in) - TPI			
B-0404-MJIC	04	1/4	6.4	04	7/16-20	25.3	12	0.10
B-0405-MJIC	04	1/4	6.4	05	1/2-20	25.3	14	0.11
B-0406-MJIC	04	1/4	6.4	06	9/16-18	26.3	17	0.13
B-0505-MJIC	05	5/16	7.9	05	1/2-20	25.3	14	0.13
B-0506-MJIC	05	5/16	7.9	06	9/16-18	26.3	17	0.14
B-0606-MJIC	06	3/8	9.5	06	9/16-18	26.3	17	0.15
B-0608-MJIC	06	3/8	9.5	08	3/4-16	29.8	19	0.19
B-0610-MJIC	06	3/8	9.5	10	7/8-14	33.8	24	0.24
B-0808-MJIC	08	1/2	12.7	08	3/4-16	30.6	19	0.22
B-0810-MJIC	08	1/2	12.7	10	7/8-14	34.6	24	0.28
B-0812-MJIC	08	1/2	12.7	12	1 1/16-12	37.1	27	0.33
B-1010-MJIC	10	5/8	15.9	10	7/8-14	34.6	24	0.31
B-1012-MJIC	10	5/8	15.9	12	1 1/16-12	37.1	27	0.37
B-1212-MJIC	12	3/4	19.0	12	1 1/16-12	37.6	27	0.44
B-1214-MJIC	12	3/4	19.0	14	1 3/16-12	40.1	32	0.51
B-1216-MJIC	12	3/4	19.0	16	1 5/16-12	42.6	36	0.62
B-1616-MJIC	16	1	25.4	16	1 5/16-12	43.4	36	0.75
B-1620-MJIC	16	1	25.4	20	1 5/8-12	46.9	46	1.01

Because we continually examine ways to improve our products, we reserve the right to alter specifications or discontinue products without prior notice.

AlfaCrimp One-Piece Fittings - B Series



HOSES

ONE-PIECE B SERIES

ONE-PIECE D SERIES

ONE-PIECE F & P SERIES

TWO-PIECE FERRULES (A & PFR SERIES)

TWO-PIECE INSERTS (A SERIES)

TWO-PIECE INTERLOCK FERRULES & INSERTS (X & Z SERIES)

QUICK RELEASE

ASSEMBLY EQUIPMENT

TECHNICAL INFORMATION

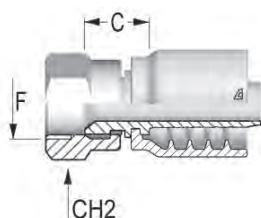

JIC Female 37° Seat

Part Number	Dash Size	Hose ID Size		F Thread		C Cut-Off Factor (mm)	CH2 (mm)	Weight (lbs/each)
		(in)	(mm)	Dash Size	Size (in) - TPI			
B-0404-FJSH	04	1/4	6.4	04	7/16-20	14.6	16	0.12
B-0405-FJSH	04	1/4	6.4	05	1/2-20	15.3	17	0.13
B-0406-FJSH	04	1/4	6.4	06	9/16-18	15.3	19	0.14
B-0505-FJSH	05	5/16	7.9	05	1/2-20	15.3	17	0.14
B-0506-FJSH	05	5/16	7.9	06	9/16-18	15.3	19	0.15
B-0606-FJSH	06	3/8	9.5	06	9/16-18	15.3	19	0.16
B-0608-FJSH	06	3/8	9.5	08	3/4-16	17.8	25	0.23
B-0806-FJSH	08	1/2	12.7	06	9/16-18	18.3	19	0.26
B-0808-FJSH	08	1/2	12.7	08	3/4-16	18.6	25	0.27
B-0810-FJSH	08	1/2	12.7	10	7/8-14	19.6	27	0.29
B-0812-FJSH	08	1/2	12.7	12	1 1/16-12	22.1	32	0.36
B-1010-FJSH	10	5/8	15.9	10	7/8-14	19.6	27	0.32
B-1012-FJSH	10	5/8	15.9	12	1 1/16-12	20.1	32	0.39
B-1210-FJSH	12	3/4	19.0	10	7/8-14	20.1	27	0.40
B-1212-FJSH	12	3/4	19.0	12	1 1/16-12	20.6	32	0.46
B-1214-FJSH	12	3/4	19.0	14	1 3/16-12	19.9	36	0.52
B-1216-FJSH	12	3/4	19.0	16	1 5/16-12	22.1	38	0.56
B-1616-FJSH	16	1	25.4	16	1 5/16-12	23.9	38	0.69
B-1620-FJSH	16	1	25.4	20	1 5/8-12	26.5	50	1.03

Because we continually examine ways to improve our products, we reserve the right to alter specifications or discontinue products without prior notice.



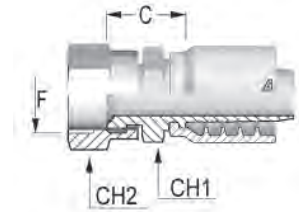

JIC Female 37° Seat Dual Hex

Part Number	Dash Size	Hose ID Size		F Thread		C Cut-Off Factor (mm)	CH1 (mm)	CH2 (mm)	Weight (lbs/each)
		(in)	(mm)	Dash Size	Size (in) - TPI				
B-0404-FJDH	04	1/4	6.4	04	7/16-20	19.6	14	16	0.13
B-0405-FJDH	04	1/4	6.4	05	1/2-20	20.3	14	17	0.14
B-0406-FJDH	04	1/4	6.4	06	9/16-18	20.3	14	19	0.15
B-0506-FJDH	05	5/16	7.9	06	9/16-18	20.3	14	19	0.16
B-0604-FJDH	06	3/8	9.5	04	7/16-20	20.6	17	16	0.17
B-0606-FJDH	06	3/8	9.5	06	9/16-18	21.3	17	19	0.18
B-0608-FJDH	06	3/8	9.5	08	3/4-16	24.8	19	25	0.26
B-0610-FJDH	06	3/8	9.5	10	7/8-14	25.8	22	27	0.29
B-0806-FJDH	08	1/2	12.7	06	9/16-18	23.1	19	19	0.24
B-0808-FJDH	08	1/2	12.7	08	3/4-16	25.6	19	25	0.30
B-0810-FJDH	08	1/2	12.7	10	7/8-14	26.6	22	27	0.32
B-0812-FJDH	08	1/2	12.7	12	1 1/16-12	28.1	25	32	0.41
B-1008-FJDH	10	5/8	15.9	08	3/4-16	26.6	24	25	0.37
B-1010-FJDH	10	5/8	15.9	10	7/8-14	27.6	24	27	0.37
B-1012-FJDH	10	5/8	15.9	12	1 1/16-12	28.1	25	32	0.45
B-1210-FJDH	12	3/4	19.0	10	7/8-14	28.1	27	27	0.50
B-1212-FJDH	12	3/4	19.0	12	1 1/16-12	28.6	27	32	0.52
B-1214-FJDH	12	3/4	19.0	14	1 3/16-12	29.9	32	36	0.62
B-1216-FJDH	12	3/4	19.0	16	1 5/16-12	32.1	32	38	0.65
B-1612-FJDH	16	1	25.4	12	1 1/16-12	31.4	32	32	0.75
B-1616-FJDH	16	1	25.4	16	1 5/16-12	32.9	32	38	0.77
B-1620-FJDH	16	1	25.4	20	1 5/8-12	37.5	41	50	1.05

Because we continually examine ways to improve our products, we reserve the right to alter specifications or discontinue products without prior notice.

AlfaCrimp One-Piece Fittings - B Series



HOSES

ONE-PIECE B SERIES

ONE-PIECE D SERIES

ONE-PIECE F & P SERIES

TWO-PIECE FERRULES (A & PFR SERIES)

TWO-PIECE INSERTS (A SERIES)

TWO-PIECE INTERLOCK FERRULES & INSERTS (X & Z SERIES)

QUICK RELEASE

ASSEMBLY EQUIPMENT

TECHNICAL INFORMATION

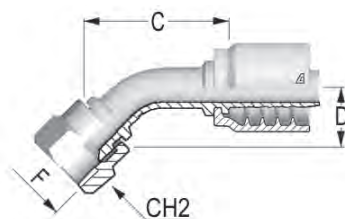

45° JIC Female 37° Seat

Part Number	Dash Size	Hose ID Size		F Thread		C Cut-Off Factor (mm)	D Drop (mm)	CH2 (mm)	Weight (lbs/each)
		(in)	(mm)	Dash Size	Size (in) - TPI				
B-0404-FJ45	04	1/4	6.4	04	7/16-20	36.6	10	16	0.14
B-0405-FJ45	04	1/4	6.4	05	1/2-20	37.2	12	17	0.15
B-0406-FJ45	04	1/4	6.4	06	9/16-18	39.4	11	19	0.16
B-0506-FJ45	05	5/16	7.9	06	9/16-18	42.8	12	19	0.19
B-0606-FJ45	06	3/8	9.5	06	9/16-18	46.3	11	19	0.20
B-0608-FJ45	06	3/8	9.5	08	3/4-16	47.2	15	25	0.26
B-0806-FJ45	08	1/2	12.7	06	9/16-18	50.2	15	19	0.30
B-0808-FJ45	08	1/2	12.7	08	3/4-16	51.6	15	25	0.32
B-0810-FJ45	08	1/2	12.7	10	7/8-14	50.7	16	27	0.34
B-0812-FJ45	08	1/2	12.7	12	1 1/16-12	57.0	21	32	0.45
B-1010-FJ45	10	5/8	15.7	10	7/8-14	62.2	19	27	0.46
B-1012-FJ45	10	5/8	15.9	12	1 1/16-12	68.6	21	32	0.55
B-1212-FJ45	12	3/4	19.0	12	1 1/16-12	67.5	21	32	0.64
B-1216-FJ45	12	3/4	19.0	16	1 5/16-12	71.4	26	38	0.82
B-1616-FJ45	16	1	25.4	16	1 5/16-12	79.4	24	38	1.02
B-1620-FJ45	16	1	25.4	20	1 5/8-12	83.8	37	50	1.07

Because we continually examine ways to improve our products, we reserve the right to alter specifications or discontinue products without prior notice.



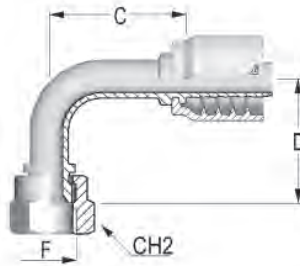

90° JIC Female 37° Seat Short Drop

Part Number	Dash Size	Hose ID Size		F Thread		C Cut-Off Factor (mm)	D Drop (mm)	CH2 (mm)	Weight (lbs/each)
		(in)	(mm)	Dash Size	Size (in) - TPI				
B-0404-FJ9S	04	1/4	6.4	04	7/16-20	27.0	21.0	16	0.14
B-0405-FJ9S	04	1/4	6.4	05	1/2-20	26.5	23.5	17	0.15
B-0406-FJ9S	04	1/4	6.4	06	9/16-18	31.0	23.0	19	0.16
B-0506-FJ9S	05	5/16	7.9	06	9/16-18	31.5	23.0	19	0.20
B-0606-FJ9S	06	3/8	9.5	06	9/16-18	42.3	23.0	19	0.20
B-0608-FJ9S	06	3/8	9.5	08	3/4-16	48.8	29.0	25	0.28
B-0806-FJ9S	08	1/2	12.7	06	9/16-18	44.6	29.0	25	0.32
B-0808-FJ9S	08	1/2	12.7	08	3/4-16	46.4	29.0	25	0.34
B-0810-FJ9S	08	1/2	12.7	10	7/8-14	45.8	32.0	27	0.36
B-0812-FJ9S	08	1/2	12.7	12	1 1/16-12	37.3	46.0	32	0.46
B-1010-FJ9S	10	5/8	15.9	10	7/8-14	49.0	32.0	27	0.49
B-1012-FJ9S	10	5/8	15.9	12	1 1/16-12	47.9	48.0	32	0.56
B-1212-FJ9S	12	3/4	19.0	12	1 1/16-12	58.2	46.0	32	0.70
B-1216-FJ9S	12	3/4	19.0	16	1 5/16-12	53.6	53.0	38	0.83
B-1616-FJ9S	16	1	25.4	16	1 5/16-12	74.0	56.0	38	1.14

Because we continually examine ways to improve our products, we reserve the right to alter specifications or discontinue products without prior notice.

AlfaCrimp One-Piece Fittings - B Series



- HOSES
- ONE-PIECE B SERIES
- ONE-PIECE D SERIES
- ONE-PIECE F & P SERIES
- TWO-PIECE FERRULES (A & PFR SERIES)
- TWO-PIECE INSERTS (A SERIES)
- TWO-PIECE INTERLOCK FERRULES & INSERTS (X & Z SERIES)
- QUICK RELEASE
- ASSEMBLY EQUIPMENT
- TECHNICAL INFORMATION

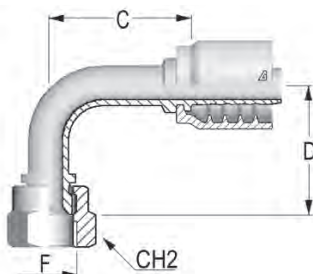

90° JIC Female 37° Seat Medium Drop

Part Number	Dash Size	Hose ID Size		F Thread		C Cut-Off Factor (mm)	D Drop (mm)	CH2 (mm)	Weight (lbs/each)
		(in)	(mm)	Dash Size	Size (in) - TPI				
B-0404-FJ9M	04	1/4	6.4	04	7/16-20	34.2	32.0	16	0.16
B-0405-FJ9M	04	1/4	6.4	05	1/2-20	25.7	30.0	17	0.16
B-0406-FJ9M	04	1/4	6.4	06	9/16-18	28.5	38.0	19	0.17
B-0505-FJ9M	05	5/16	7.9	05	1/2-20	34.2	32.0	17	0.19
B-0506-FJ9M	05	5/16	7.9	06	9/16-18	33.2	35.0	19	0.22
B-0606-FJ9M	06	3/8	9.5	06	9/16-18	31.3	35.0	19	0.22
B-0608-FJ9M	06	3/8	9.5	08	3/4-16	39.5	41.0	25	0.30
B-0808-FJ9M	08	1/2	12.7	08	3/4-16	37.2	40.0	25	0.35
B-0810-FJ9M	08	1/2	12.7	10	7/8-14	43.3	47.0	27	0.40
B-0812-FJ9M	08	1/2	12.7	12	1 1/16-12	42.8	58.0	32	0.49
B-1010-FJ9M	10	5/8	15.9	10	7/8-14	49.4	48.0	27	0.51
B-1012-FJ9M	10	5/8	15.9	12	1 1/16-12	47.9	58.0	32	0.60
B-1212-FJ9M	12	3/4	19.0	12	1 1/16-12	52.4	54.0	32	0.70
B-1216-FJ9M	12	3/4	19.0	16	1 5/16-12	52.6	72.0	38	0.86
B-1616-FJ9M	16	1	25.4	16	1 5/16-12	72.6	71.5	38	1.19
B-1620-FJ9M	16	1	25.4	20	1 5/8-12	72.6	78.0	50	1.21

Because we continually examine ways to improve our products, we reserve the right to alter specifications or discontinue products without prior notice.



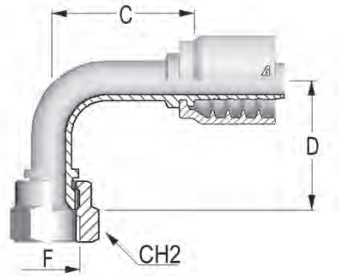

90° JIC Female 37° Seat Long Drop

Part Number	Dash Size	Hose ID Size		F Thread		C Cut-Off Factor (mm)	D Drop (mm)	CH2 (mm)	Weight (lbs/each)
		(in)	(mm)	Dash Size	Size (in) - TPI				
B-0404-FJ9L	04	1/4	6.4	04	7/16-20	30.8	46	16	0.17
B-0405-FJ9L	04	1/4	6.4	05	1/2-20	26.0	45	17	0.20
B-0406-FJ9L	04	1/4	6.4	06	9/16-18	26.0	54	17	0.27
B-0606-FJ9L	06	3/8	9.5	06	9/16-18	43.3	54	19	0.27
B-0608-FJ9L	06	3/8	9.5	08	3/4-16	46.8	64	25	0.28
B-0808-FJ9L	08	1/2	12.7	08	3/4-16	49.9	64	25	0.33
B-0810-FJ9L	08	1/2	12.7	10	7/8-14	37.3	65	27	0.42
B-1010-FJ9L	10	5/8	15.9	10	7/8-14	49.9	65	27	0.68
B-1212-FJ9L	12	3/4	19.0	12	1 1/16-12	54.1	95	32	0.84
B-1216-FJ9L	12	3/4	19.0	16	1 5/16-12	66.4	103	38	1.00
B-1616-FJ9L	16	1	25.4	16	1 5/16-12	78.6	114	38	1.14

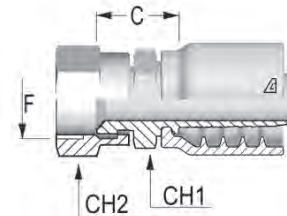

SAE Female Swivel 45° Seat

Part Number	Dash Size	Hose ID Size		F Thread		C Cut-Off Factor (mm)	CH1 (mm)	CH2 (mm)	Weight (lbs/each)
		(in)	(mm)	Dash Size	Size (in) - TPI				
B-0606-FSAE	06	3/8	9.5	06	5/8-18	23.3	19	22	0.23
B-1212-FSAE	12	3/4	19.0	12	1 1/16-14	28.6	27	32	0.52

Because we continually examine ways to improve our products, we reserve the right to alter specifications or discontinue products without prior notice.

AlfaCrimp One-Piece Fittings - B Series



HOSES

ONE-PIECE B SERIES

ONE-PIECE D SERIES

ONE-PIECE F & P SERIES

TWO-PIECE FERRULES (A & PFR SERIES)

TWO-PIECE INSERTS (A SERIES)

TWO-PIECE INTERLOCK FERRULES & INSERTS (X & Z SERIES)

QUICK RELEASE

ASSEMBLY EQUIPMENT

TECHNICAL INFORMATION

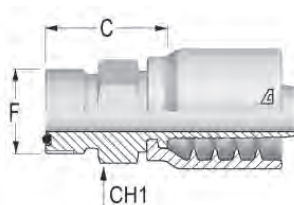

ORFS Male

Part Number	Dash Size	Hose ID Size		F Thread		C Cut-Off Factor (mm)	CH1 (mm)	Weight (lbs/each)
		(in)	(mm)	Dash Size	Size (in) - TPI			
B-0404-MOFS	04	1/4	6.4	04	9/16-18	22.3	17	0.13
B-0406-MOFS	04	1/4	6.4	06	11/16-16	24.3	19	0.15
B-0606-MOFS	06	3/8	9.5	06	11/16-16	24.3	19	0.17
B-0608-MOFS	06	3/8	9.5	08	13/16-16	26.3	22	0.21
B-0610-MOFS	06	3/8	9.5	10	1-14	29.8	27	0.28
B-0808-MOFS	08	1/2	12.7	08	13/16-16	27.1	22	0.24
B-0810-MOFS	08	1/2	12.7	10	1-14	30.6	27	0.32
B-0812-MOFS	08	1/2	12.7	12	1 3/16-12	34.1	32	0.43
B-1010-MOFS	10	5/8	15.9	10	1-14	30.6	27	0.35
B-1012-MOFS	10	5/8	15.9	12	1 3/16-12	34.1	32	0.47
B-1210-MOFS	12	3/4	19.0	10	1-14	34.6	32	0.51
B-1212-MOFS	12	3/4	19.0	12	1 3/16-12	34.6	32	0.53
B-1216-MOFS	12	3/4	19.0	16	1 7/16-12	38.1	41	0.74
B-1616-MOFS	16	1	25.4	16	1 7/16-12	37.9	38	0.81
B-1620-MOFS	16	1	25.4	20	1 11/16-12	39.9	46	1.00

Because we continually examine ways to improve our products, we reserve the right to alter specifications or discontinue products without prior notice.



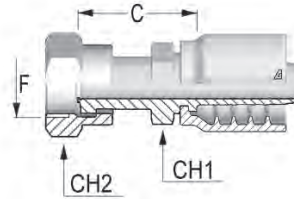

ORFS Female with Stem Hexagon

Part Number	Dash Size	Hose ID Size		F Thread		C Cut-Off Factor (mm)	CH1 (mm)	CH2 (mm)	Weight (lbs/each)
		(in)	(mm)	Dash Size	Size (in) - TPI				
B-0404-FOFS	04	1/4	6.4	04	9/16-18	27.3	14	17	0.14
B-0406-FOFS	04	1/4	6.4	06	11/16-16	30.3	17	22	0.20
B-0408-FOFS	04	1/4	6.4	08	13/16-16	35.3	22	24	0.27
B-0506-FOFS	05	5/16	7.9	06	11/16-16	30.3	17	22	0.21
B-0606-FOFS	06	3/8	9.5	06	11/16-16	30.3	17	22	0.22
B-0608-FOFS	06	3/8	9.5	08	13/16-16	35.3	22	24	0.28
B-0806-FOFS	08	1/2	12.7	06	11/16-16	32.1	19	22	0.27
B-0808-FOFS	08	1/2	12.7	08	13/16-16	36.1	22	24	0.31
B-0810-FOFS	08	1/2	12.7	10	1-14	39.6	24	30	0.40
B-0812-FOFS	08	1/2	12.7	12	1 3/16-12	42.1	30	36	0.62
B-1010-FOFS	10	5/8	15.9	10	1-14	39.6	24	30	0.44
B-1012-FOFS	10	5/8	15.9	12	1 3/16-12	42.1	30	36	0.64
B-1210-FOFS	12	3/4	19.0	10	1-14	40.1	27	30	0.53
B-1212-FOFS	12	3/4	19.0	12	1 3/16-12	42.6	30	36	0.68
B-1216-FOFS	12	3/4	19.0	16	1 7/16-12	48.6	36	41	0.95
B-1612-FOFS	16	1	25.4	12	1 3/16-12	45.4	32	36	0.89
B-1616-FOFS	16	1	25.4	16	1 7/16-12	49.4	36	41	1.02
B-1620-FOFS	16	1	25.4	20	1 11/16-12	50.4	41	50	1.38

Because we continually examine ways to improve our products, we reserve the right to alter specifications or discontinue products without prior notice.

AlfaCrimp One-Piece Fittings - B Series



HOSES

ONE-PIECE B SERIES

ONE-PIECE D SERIES

ONE-PIECE F & P SERIES

TWO-PIECE FERRULES (A & PFR SERIES)

TWO-PIECE INSERTS (A SERIES)

TWO-PIECE INTERLOCK FERRULES & INSERTS (X & Z SERIES)

QUICK RELEASE

ASSEMBLY EQUIPMENT

TECHNICAL INFORMATION

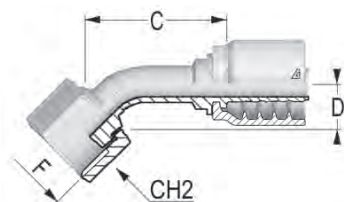

45° ORFS Female

Part Number	Dash Size	Hose ID Size		F Thread		C Cut-Off Factor (mm)	D Drop (mm)	CH2 (mm)	Weight (lbs/each)
		(in)	(mm)	Dash Size	Size (in) - TPI				
B-0404-F045	04	1/4	6.4	04	9/16-18	41.1	11.0	17	0.15
B-0406-F045	04	1/4	6.4	06	11/16-16	46.1	11.0	22	0.19
B-0506-F045	05	5/16	7.9	06	11/16-16	46.3	12.0	22	0.22
B-0606-F045	06	3/8	9.5	06	11/16-16	47.4	12.0	22	0.23
B-0608-F045	06	3/8	9.5	08	13/16-16	51.2	15.0	24	0.27
B-0806-F045	08	1/2	12.7	06	11/16-16	47.1	16.0	22	0.26
B-0808-F045	08	1/2	12.7	08	13/16-16	47.1	16.0	24	0.29
B-0810-F045	08	1/2	12.7	10	1-14	50.4	16.5	30	0.43
B-1010-F045	10	5/8	15.9	10	1-14	57.7	17.0	30	0.49
B-1012-F045	10	5/8	15.9	12	1 3/16-12	63.1	21.0	36	0.64
B-1212-F045	12	3/4	19.0	12	1 3/16-12	63.5	21.0	36	0.76
B-1216-F045	12	3/4	19.0	16	1 7/16-12	70.7	24.0	41	0.88
B-1616-F045	16	1	25.4	16	1 7/16-12	82.4	26.0	41	1.12
B-1620-F045	16	1	25.4	20	1 11/16-12	85.4	26.0	50	1.42

Because we continually examine ways to improve our products, we reserve the right to alter specifications or discontinue products without prior notice.



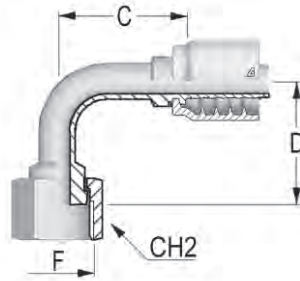

90° ORFS Female Short Drop

Part Number	Dash Size	Hose ID Size		F Thread		C Cut-Off Factor (mm)	D Drop (mm)	CH2 (mm)	Weight (lbs/each)
		(in)	(mm)	Dash Size	Size (in) - TPI				
B-0404-F09S	04	1/4	6.4	04	9/16-18	28.5	21.0	17	0.15
B-0406-F09S	04	1/4	6.4	06	11/16-16	32.0	23.0	22	0.19
B-0506-F09S	05	5/16	7.9	06	11/16-16	32.0	25.0	22	0.23
B-0606-F09S	06	3/8	9.5	06	11/16-16	41.8	25.0	22	0.23
B-0608-F09S	06	3/8	9.5	08	13/16-16	41.8	29.0	24	0.27
B-0808-F09S	08	1/2	12.7	08	13/16-16	39.8	29.0	24	0.31
B-0810-F09S	08	1/2	12.7	10	1-14	46.3	32.5	30	0.45
B-0812-F09S	08	1/2	12.7	12	1 3/16-12	50.1	35.0	36	0.69
B-1010-F09S	10	5/8	15.9	10	1-14	52.3	32.5	30	0.52
B-1012-F09S	10	5/8	15.9	12	1 3/16-12	55.4	49.0	36	0.71
B-1212-F09S	12	3/4	19.0	12	1 3/16-12	60.6	51.0	36	0.84
B-1216-F09S	12	3/4	19.0	16	1 7/16-12	61.6	56.0	41	0.77
B-1616-F09S	16	1	25.4	16	1 7/16-12	80.0	58.0	41	1.27
B-1620-F09S	16	1	25.4	20	1 11/16-12	85.4	26.0	50	1.62

Because we continually examine ways to improve our products, we reserve the right to alter specifications or discontinue products without prior notice.

AlfaCrimp One-Piece Fittings - B Series



HOSES
ONE-PIECE B SERIES
ONE-PIECE D SERIES
ONE-PIECE F & P SERIES
TWO-PIECE FERRULES (A & PFR SERIES)
TWO-PIECE INSERTS (A SERIES)
TWO-PIECE INTERLOCK FERRULES & INSERTS (X & Z SERIES)
QUICK RELEASE
ASSEMBLY EQUIPMENT
TECHNICAL INFORMATION

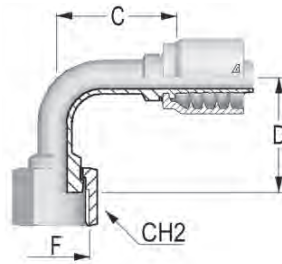

90° ORFS Female Medium Drop

Part Number	Dash Size	Hose ID Size		F Thread		C Cut-Off Factor (mm)	D Drop (mm)	CH2 (mm)	Weight (lbs/each)
		(in)	(mm)	Dash Size	Size (in) - TPI				
B-0404-F09M	04	1/4	6.4	04	9/16-18	29.8	32	17	0.17
B-0406-F09M	04	1/4	6.4	06	11/16-16	37.3	38	22	0.22
B-0506-F09M	05	5/16	7.9	06	11/16-16	40.7	34	22	0.26
B-0606-F09M	06	3/8	9.5	06	11/16-16	41.8	38	22	0.25
B-0608-F09M	06	3/8	9.5	08	13/16-16	43.8	41	24	0.30
B-0808-F09M	08	1/2	12.7	08	13/16-16	34.8	42	24	0.32
B-0810-F09M	08	1/2	12.7	10	1-14	48.3	47	30	0.48
B-1010-F09M	10	5/8	15.9	10	1-14	55.4	44	30	0.55
B-1012-F09M	10	5/8	15.9	12	1 3/16-12	55.4	58	36	0.73
B-1212-F09M	12	3/4	19.0	12	1 3/16-12	61.6	58	36	0.87
B-1216-F09M	12	3/4	19.0	16	1 7/16-12	65.5	71	41	1.05
B-1616-F09M	16	1	25.4	16	1 7/16-12	82.6	66	41	1.31
B-1620-F09M	16	1	25.4	20	1 11/16-12	82.6	78	50	1.69

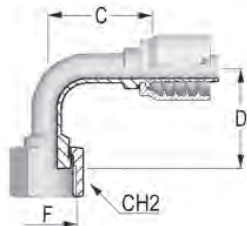

90° ORFS Female Long Drop

Part Number	Dash Size	Hose ID Size		F Thread		C Cut-Off Factor (mm)	D Drop (mm)	CH2 (mm)	Weight (lbs/each)
		(in)	(mm)	Dash Size	Size (in) - TPI				
B-0404-F09L	04	1/4	6.4	04	9/16-18	32.8	46	17	0.18
B-0406-F09L	04	1/4	6.4	06	11/16-16	34.8	54	22	0.23
B-0506-F09L	05	5/16	7.9	06	11/16-16	32.0	54	22	0.28
B-0606-F09L	06	3/8	9.5	06	11/16-16	41.8	54	22	0.26
B-0608-F09L	06	3/8	9.5	08	13/16-16	46.8	64	24	0.33
B-0808-F09L	08	1/2	12.7	08	13/16-16	38.3	64	24	0.35
B-0810-F09L	08	1/2	12.7	10	1-14	46.3	70	30	0.50
B-1010-F09L	10	5/8	15.9	10	1-14	55.4	70	30	0.61
B-1212-F09L	12	3/4	19.0	12	1 3/16-12	61.6	96	36	0.97
B-1216-F09L	12	3/4	19.0	16	1 5/16-12	72.1	104	41	1.33
B-1616-F09L	16	1	25.4	16	1 5/16-12	82.6	114	41	1.53

Because we continually examine ways to improve our products, we reserve the right to alter specifications or discontinue products without prior notice.



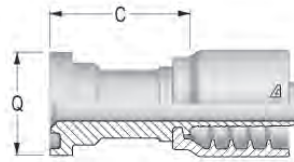

Flange SAE 3000 PSI J518 Code 61

Part Number	Dash Size	Hose ID Size		Flange		Q (mm)	C Cut-Off Factor (mm)	Weight (lbs/each)
		(in)	(mm)	Dash Size	(in)			
B-0808-C61S	08	1/2	12.7	08	1/2	30.2	41.0	0.35
B-0812-C61S	08	1/2	12.7	12	3/4	38.1	42.0	0.44
B-1212-C61S	12	3/4	19.0	12	3/4	38.1	42.5	0.57
B-1216-C61S	12	3/4	19.0	16	1	44.5	50.5	0.71
B-1616-C61S	16	1	25.4	16	1	44.5	51.4	0.90
B-1620-C61S	16	1	25.4	20	1 1/4	50.8	53.9	1.00

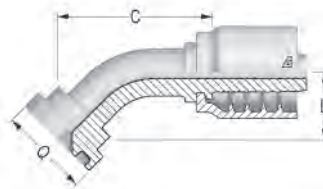

45° Flange SAE 3000 PSI J518 Code 61

Part Number	Dash Size	Hose ID Size		Flange		Q (mm)	C Cut-Off Factor (mm)	D Drop (mm)	Weight (lbs/each)
		(in)	(mm)	Dash Size	(in)				
B-0808-C614	08	1/2	12.7	08	1/2	30.2	43.7	22.0	0.35
B-0812-C614	08	1/2	12.7	12	3/4	38.1	50.4	26.0	0.48
B-1012-C614	10	5/8	15.9	12	3/4	38.1	55.1	26.0	0.53
B-1212-C614	12	3/4	19.0	12	3/4	38.1	63.8	32.0	0.73
B-1216-C614	12	3/4	19.0	16	1	44.5	68.0	29.0	0.84
B-1616-C614	16	1	25.4	16	1	44.5	72.8	33.5	1.08
B-1620-C614	16	1	25.4	20	1 1/4	50.8	72.3	36.0	1.16

Because we continually examine ways to improve our products, we reserve the right to alter specifications or discontinue products without prior notice.

AlfaCrimp One-Piece Fittings - B Series



HOSES
ONE-PIECE B SERIES
ONE-PIECE D SERIES
ONE-PIECE F & P SERIES
TWO-PIECE FERRULES (A & PFR SERIES)
TWO-PIECE INSERTS (A SERIES)
TWO-PIECE INTERLOCK FERRULES & INSERTS (X & Z SERIES)
QUICK RELEASE
ASSEMBLY EQUIPMENT
TECHNICAL INFORMATION

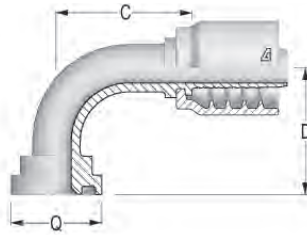

90° Flange SAE 3000 PSI J518 Code 61

Part Number	Dash Size	Hose ID Size		Flange		Q (mm)	C Cut-Off Factor (mm)	D Drop (mm)	Weight (lbs/each)
		(in)	(mm)	Dash Size	(in)				
B-0808-C619	08	1/2	12.7	08	1/2	30.2	45.8	42.0	0.39
B-0812-C619	08	1/2	12.7	12	3/4	38.1	45.3	51.0	0.52
B-1212-C619	12	3/4	19.0	12	3/4	38.1	59.7	58.0	0.81
B-1216-C619	12	3/4	19.0	16	1	44.5	66.2	64.5	0.97
B-1616-C619	16	1	25.4	16	1	44.5	70.6	67.0	1.18
B-1620-C619	16	1	25.4	20	1 1/4	50.8	73.6	71.0	1.30
B-1624-C619	16	1	25.4	24	1 1/2	60.3	93.1	75.0	2.07

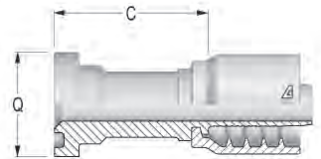

Flange SAE 6000 PSI J518 Code 62

Part Number	Dash Size	Hose ID Size		Flange		Q (mm)	C Cut-Off Factor (mm)	Weight (lbs/each)
		(in)	(mm)	Dash Size	(in)			
B-0808-C62S	08	1/2	12.7	08	1/2	31.8	47.0	0.39
B-0812-C62S	08	1/2	12.7	12	3/4	41.3	52.0	0.56
B-1212-C62S	12	3/4	19.0	12	3/4	41.3	52.5	0.69
B-1216-C62S	12	3/4	19.0	16	1	47.6	55.5	0.85
B-1612-C62S	16	1	25.4	12	3/4	41.3	56.4	0.89
B-1616-C62S	16	1	25.4	16	1	47.6	56.4	1.03
B-1620-C62S	16	1	25.4	20	1 1/4	54.0	63.4	1.27

Because we continually examine ways to improve our products, we reserve the right to alter specifications or discontinue products without prior notice.



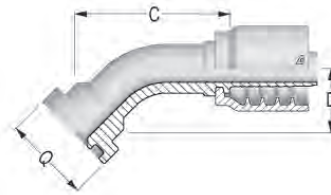

45° Flange SAE 6000 PSI J518 Code 62

Part Number	Dash Size	Hose ID Size		Flange		Q (mm)	C Cut-Off Factor (mm)	D Drop (mm)	Weight (lbs/each)
		(in)	(mm)	Dash Size	(in)				
B-0808-C624	08	1/2	12.7	08	1/2	31.8	46.6	23.0	0.39
B-0812-C624	08	1/2	12.7	12	3/4	41.3	67.2	30.5	0.67
B-1212-C624	12	3/4	19.0	12	3/4	41.3	71.4	31.0	0.85
B-1216-C624	12	3/4	19.0	16	1	47.6	65.2	33.5	1.00
B-1616-C624	16	1	25.4	16	1	47.6	81.9	36.0	1.23
B-1620-C624	16	1	25.4	20	1 1/4	54.0	78.4	39.0	1.47

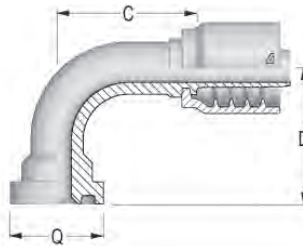

90° Flange SAE 6000 PSI J518 Code 62

Part Number	Dash Size	Hose ID Size		Flange		Q (mm)	C Cut-Off Factor (mm)	D Drop (mm)	Weight (lbs/each)
		(in)	(mm)	Dash Size	(in)				
B-0808-C629	08	1/2	12.7	08	1/2	31.8	47.8	46	0.43
B-0812-C629	08	1/2	12.7	12	3/4	41.3	47.8	54	0.67
B-1012-C629	10	5/8	15.9	12	3/4	41.3	49.9	55	0.67
B-1212-C629	12	3/4	19.0	12	3/4	41.3	63.2	61	0.92
B-1216-C629	12	3/4	19.0	16	1	47.6	63.2	66	1.09
B-1616-C629	16	1	25.4	16	1	47.6	73.6	75	1.36
B-1620-C629	16	1	25.4	20	1 1/4	54.0	77.6	78	1.60

Because we continually examine ways to improve our products, we reserve the right to alter specifications or discontinue products without prior notice.

AlfaCrimp One-Piece Fittings - B Series



HOSES
ONE-PIECE B SERIES
ONE-PIECE D SERIES
ONE-PIECE F & P SERIES
TWO-PIECE FERRULES (A & PFR SERIES)
TWO-PIECE INSERTS (A SERIES)
TWO-PIECE INTERLOCK FERRULES & INSERTS (X & Z SERIES)
QUICK RELEASE
ASSEMBLY EQUIPMENT
TECHNICAL INFORMATION

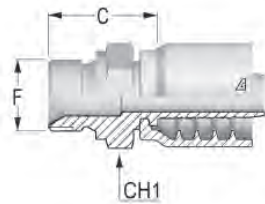

BSPP Male Parallel 60° Flare

Part Number	Dash Size	Hose ID Size		F Thread		C Cut-Off Factor (mm)	CH1 (mm)	Weight (lbs/each)
		(in)	(mm)	Dash Size	Size (in) - TPI			
B-0402-MBPP	04	1/4	6.4	02	1/8-28	21.7	14	0.10
B-0404-MBPP	04	1/4	6.4	04	1/4-19	26.3	19	0.14
B-0406-MBPP	04	1/4	6.4	06	3/8-19	27.8	22	0.17
B-0506-MBPP	05	5/16	7.9	06	3/8-19	27.8	22	0.18
B-0606-MBPP	06	3/8	9.5	06	3/8-19	27.8	22	0.19
B-0608-MBPP	06	3/8	9.5	08	1/2-14	31.3	27	0.25
B-0806-MBPP	08	1/2	12.7	06	3/8-19	28.6	22	0.23
B-0808-MBPP	08	1/2	12.7	08	1/2-14	32.1	27	0.29
B-0810-MBPP	08	1/2	12.7	10	5/8-14	36.1	30	0.32
B-0812-MBPP	08	1/2	12.7	12	3/4-14	34.1	32	0.39
B-1010-MBPP	10	5/8	15.9	10	5/8-14	36.1	30	0.36
B-1012-MBPP	10	5/8	15.9	12	3/4-14	34.1	32	0.42
B-1212-MBPP	12	3/4	19.0	12	3/4-14	34.6	32	0.50
B-1216-MBPP	12	3/4	19.0	16	1-11	39.6	41	0.69
B-1616-MBPP	16	1	25.4	16	1-11	40.4	41	0.83
B-1620-MBPP	16	1	25.4	20	1 1/4-11	42.4	50	1.12

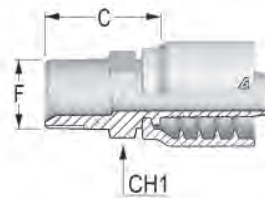

BSPT/JIS Male Tapered

Part Number	Dash Size	Hose ID Size		F Thread		C Cut-Off Factor (mm)	CH1 (mm)	Weight (lbs/each)
		(in)	(mm)	Dash Size	Size (in) - TPI			
B-0402-MBPT	04	1/4	6.4	02	1/8-28	21.3	12	0.10
B-0404-MBPT	04	1/4	6.4	04	1/4-19	26.8	17	0.13
B-0406-MBPT	04	1/4	6.4	06	3/8-19	27.8	19	0.15
B-0506-MBPT	05	5/16	7.9	06	3/8-19	27.8	19	0.16
B-0606-MBPT	06	3/8	9.5	06	3/8-19	27.8	19	0.18
B-0608-MBPT	06	3/8	9.5	08	1/2-14	32.3	22	0.24
B-0808-MBPT	08	1/2	12.7	08	1/2-14	33.1	22	0.27
B-1012-MBPT	10	5/8	15.9	12	3/4-14	34.1	27	0.35
B-1212-MBPT	12	3/4	19.0	12	3/4-14	34.6	27	0.44
B-1216-MBPT	12	3/4	19.0	16	1-11	43.6	36	0.63
B-1616-MBPT	16	1	25.4	16	1-11	44.4	36	0.77

Because we continually examine ways to improve our products, we reserve the right to alter specifications or discontinue products without prior notice.



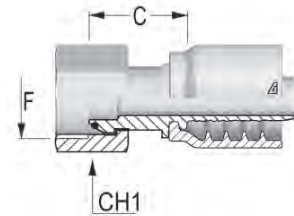

BSPP Female 60° Cone with O-Ring

Part Number	Dash Size	Hose ID Size		F Thread		C Cut-Off Factor (mm)	CH1 (mm)	Weight (lbs/each)
		(in)	(mm)	Dash Size	Size (in) - TPI			
B-0404-FBPO	04	1/4	6.4	04	1/4-19	16.0	19	0.15
B-0406-FBPO	04	1/4	6.4	06	3/8-19	16.0	22	0.19
B-0506-FBPO	05	5/16	7.9	06	3/8-19	23.3	22	0.20
B-0604-FBPO	06	3/8	9.5	04	1/4-19	17.3	19	0.18
B-0606-FBPO	06	3/8	9.5	06	3/8-19	17.0	22	0.21
B-0608-FBPO	06	3/8	9.5	08	1/2-14	24.3	27	0.27
B-0808-FBPO	08	1/2	12.7	08	1/2-14	18.0	27	0.30
B-0810-FBPO	08	1/2	12.7	10	5/8-14	28.4	27	0.32
B-0812-FBPO	08	1/2	12.7	12	3/4-14	22.0	32	0.41
B-1010-FBPO	10	5/8	15.9	10	5/8-14	17.1	27	0.28
B-1012-FBPO	10	5/8	15.9	12	3/4-14	20.0	32	0.43
B-1212-FBPO	12	3/4	19.0	12	3/4-14	20.6	32	0.43
B-1216-FBPO	12	3/4	19.0	16	1-11	34.0	38	0.64
B-1616-FBPO	16	1	25.4	16	1-11	23.9	38	0.66
B-1620-FBPO	16	1	25.4	20	1 1/4-11	39.4	50	1.18

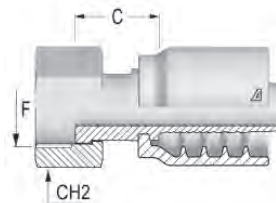

BSPP Female Flat Seat

Part Number	Dash Size	Hose ID Size		F Thread		C Cut-Off Factor (mm)	CH2 (mm)	Weight (lbs/each)
		(in)	(mm)	Dash Size	Size (in) - TPI			
B-0606-FBFS	06	3/8	9.5	06	3/8-19	20.3	22	0.20
B-0608-FBFS	06	3/8	9.5	08	1/2-14	20.8	27	0.27
B-0808-FBFS	08	1/2	12.7	08	1/2-14	21.6	27	0.30
B-1212-FBFS	12	3/4	19.0	12	3/4-14	18.1	32	0.42

Because we continually examine ways to improve our products, we reserve the right to alter specifications or discontinue products without prior notice.

AlfaCrimp One-Piece Fittings - B Series



HOSES

ONE-PIECE B SERIES

ONE-PIECE D SERIES

ONE-PIECE F & P SERIES

TWO-PIECE FERRULES (A & PFR SERIES)

TWO-PIECE INSERTS (A SERIES)

TWO-PIECE INTERLOCK FERRULES & INSERTS (X & Z SERIES)

QUICK RELEASE

ASSEMBLY EQUIPMENT

TECHNICAL INFORMATION

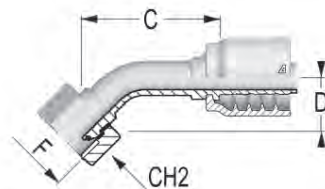

45° BSPP Female 60° Cone with O-Ring

Part Number	Dash Size	Hose ID Size		F Thread		C Cut-Off Factor (mm)	D Drop (mm)	CH2 (mm)	Weight (lbs/each)
		(in)	(mm)	Dash Size	Size (in) - TPI				
B-0404-FB04	04	1/4	6.4	04	1/4-19	45.5	15.0	19	0.17
B-0406-FB04	04	1/4	6.4	06	3/8-19	41.5	18.0	22	0.21
B-0506-FB04	05	5/16	7.9	06	3/8-19	45.1	19.0	22	0.24
B-0606-FB04	06	3/8	9.5	06	3/8-19	49.9	20.5	22	0.25
B-0608-FB04	06	3/8	9.5	08	1/2-14	45.7	21.0	27	0.31
B-0808-FB04	08	1/2	12.7	08	1/2-14	55.0	21.0	27	0.36
B-0810-FB04	08	1/2	12.7	10	5/8-14	57.2	23.0	27	0.38
B-0812-FB04	08	1/2	12.7	12	3/4-14	56.7	23.0	32	0.46
B-1010-FB04	10	5/8	15.9	10	5/8-14	64.0	21.5	27	0.42
B-1012-FB04	10	5/8	15.9	12	3/4-14	66.5	22.5	32	0.54
B-1212-FB04	12	3/4	19.0	12	3/4-14	67.6	28.0	32	0.57
B-1216-FB04	12	3/4	19.0	16	1-11	74.5	31.5	38	0.85
B-1616-FB04	16	1	25.4	16	1-11	72.5	34.0	38	1.03

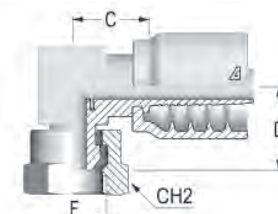

90° Compact BSPP Female 60° Cone

Part Number	Dash Size	Hose ID Size		F Thread		C Cut-Off Factor (mm)	D Drop (mm)	CH2 (mm)	Weight (lbs/each)
		(in)	(mm)	Dash Size	Size (in) - TPI				
B-0404-FBC9	04	3/8	6.4	04	1/4-19	16.8	19.5	19	0.13
B-0606-FBC9	06	3/8	9.5	06	3/8-19	19.5	21.5	22	0.16
B-0808-FBC9	08	1/2	12.7	08	1/2-14	22.2	22.5	27	0.27
B-1212-FBC9	12	3/4	19.0	12	3/4-14	26.7	31.0	32	0.66
B-1616-FBC9	16	1	25.4	16	1-11	34.5	27.5	38	0.96

Because we continually examine ways to improve our products, we reserve the right to alter specifications or discontinue products without prior notice.



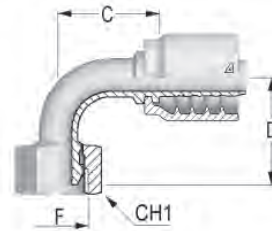

90° BSPP Female 60° Cone with O-Ring

Part Number	Dash Size	Hose ID Size		F Thread		C Cut-Off Factor (mm)	D Drop (mm)	CH1 (mm)	Weight (lbs/each)
		(in)	(mm)	Dash Size	Size (in) - TPI				
B-0404-FB09	04	1/4	6.4	04	1/4-19	29.3	29.0	19	0.17
B-0406-FB09	04	1/4	6.4	06	3/8-19	29.8	31.0	22	0.22
B-0506-FB09	05	5/16	7.9	06	3/8-19	33.2	36.0	22	0.25
B-0606-FB09	06	3/8	9.5	06	3/8-19	34.8	42.0	22	0.26
B-0608-FB09	06	3/8	9.5	08	1/2-14	34.3	35.5	27	0.32
B-0808-FB09	08	1/2	12.7	08	1/2-14	35.8	41.0	27	0.37
B-0810-FB09	08	1/2	12.7	10	5/8-14	42.5	44.0	27	0.40
B-0812-FB09	08	1/2	12.7	12	3/4-14	42.5	43.0	32	0.48
B-1010-FB09	10	5/8	15.9	10	5/8-14	47.9	47.0	27	0.47
B-1012-FB09	10	5/8	15.9	12	3/4-14	51.9	49.0	32	0.57
B-1212-FB09	12	3/4	19.0	12	3/4-14	53.5	53.0	32	0.66
B-1216-FB09	12	3/4	19.0	16	1-11	54.0	61.0	38	0.91
B-1616-FB09	16	1	25.4	16	1-11	75.1	69.0	38	1.16
B-1620-FB09	16	1	25.4	20	1 1/4-11	75.1	88.5	50	1.68

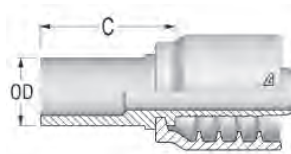

Metric Straight Standpipe DIN 2353

Part Number	Dash Size	Hose ID Size		Dash Size	Tube OD (mm)	C Cut-Off Factor (mm)	Weight (lbs/each)
		(in)	(mm)				
B-0408-MSPS	04	1/4	6.4	08	8	30.2	0.10
B-0610-MSPS	06	3/8	9.5	10	10	30.3	0.13
B-0815-MSPS	08	1/2	12.7	15	15	32.1	0.20
B-0816-MSPS	08	1/2	12.7	16	16	37.1	0.22

Because we continually examine ways to improve our products, we reserve the right to alter specifications or discontinue products without prior notice.

AlfaCrimp One-Piece Fittings - B Series



HOSES
ONE-PIECE B SERIES
ONE-PIECE D SERIES
ONE-PIECE F & P SERIES
TWO-PIECE FERRULES (A & PFR SERIES)
TWO-PIECE INSERTS (A SERIES)
TWO-PIECE INTERLOCK FERRULES & INSERTS (X & Z SERIES)
QUICK RELEASE
ASSEMBLY EQUIPMENT
TECHNICAL INFORMATION

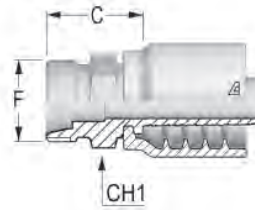

Metric Male 24° Seat - Light DIN 3853

Part Number	Dash Size	Hose ID Size		F Thread Dia x Pitch	Tube OD (mm)	C Cut-Off Factor (mm)	CH1 (mm)	Weight (lbs/each)
		(in)	(mm)					
B-0412-MMSL	04	1/4	6.4	12x1.5	6	21.3	14	0.11
B-0414-MMSL	04	1/4	6.4	14x1.5	8	21.3	14	0.11
B-0416-MMSL	04	1/4	6.4	16x1.5	10	23.3	17	0.12
B-0516-MMSL	05	5/16	7.9	16x1.5	10	23.3	17	0.14
B-0518-MMSL	05	5/16	7.9	18x1.5	12	24.3	19	0.15
B-0616-MMSL	06	3/8	9.5	16x1.5	10	23.3	17	0.15
B-0618-MMSL	06	3/8	9.5	18x1.5	12	24.3	19	0.16
B-0622-MMSL	06	3/8	9.5	22x1.5	15	25.3	22	0.19
B-0822-MMSL	08	1/2	12.7	22x1.5	15	26.1	22	0.23
B-0826-MMSL	08	1/2	12.7	26x1.5	18	27.1	27	0.28
B-1026-MMSL	10	5/8	15.9	26x1.5	18	27.1	27	0.32
B-1230-MMSL	12	3/4	19.0	30x2.0	22	31.6	32	0.45
B-1636-MMSL	16	1	25.4	36x2.0	28	34.4	36	0.66

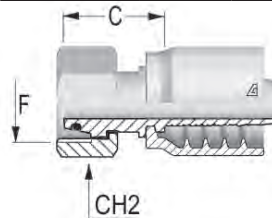

Metric Female 24° Cone with O-Ring - Light DIN 3865

Part Number	Dash Size	Hose ID Size		F Thread Dia x Pitch	Tube OD (mm)	C Cut-Off Factor (mm)	CH2 (mm)	Weight (lbs/each)
		(in)	(mm)					
B-0412-FMOL	04	1/4	6.4	12x1.5	6	24.8	14	0.11
B-0414-FMOL	04	1/4	6.4	14x1.5	8	24.4	17	0.13
B-0416-FMOL	04	1/4	6.4	16x1.5	10	25.4	19	0.15
B-0516-FMOL	05	5/16	7.9	16x1.5	10	25.4	19	0.16
B-0616-FMOL	06	3/8	9.5	16x1.5	10	25.4	19	0.18
B-0618-FMOL	06	3/8	9.5	18x1.5	12	25.4	22	0.20
B-0622-FMOL	06	3/8	9.5	22x1.5	15	27.4	27	0.27
B-0822-FMOL	08	1/2	12.7	22x1.5	15	28.2	27	0.30
B-0826-FMOL	08	1/2	12.7	26x1.5	18	29.2	32	0.38
B-1026-FMOL	10	5/8	15.9	26x1.5	18	29.2	32	0.40
B-1230-FMOL	12	3/4	19.0	30x2.0	22	31.7	36	0.55
B-1636-FMOL	16	1	25.4	36x2.0	28	33.6	41	0.77

Because we continually examine ways to improve our products, we reserve the right to alter specifications or discontinue products without prior notice.



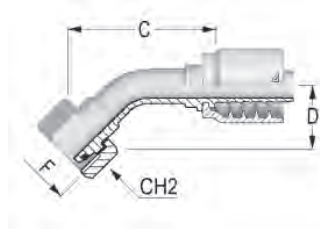

45° Metric Female 24° Cone with O-Ring - Light DIN 3865

Part Number	Dash Size	Hose ID Size		F Thread Dia x Pitch	Tube OD (mm)	C Cut-Off Factor (mm)	D Drop (mm)	CH2 (mm)	Weight (lbs/each)
		(in)	(mm)						
B-0414-FM4L	04	1/4	6.4	14x1.5	8	43.0	17.5	17	0.15
B-0416-FM4L	04	1/4	6.4	16x1.5	10	42.0	20.0	19	0.17
B-0516-FM4L	05	5/16	7.9	16x1.5	10	47.5	20.0	19	0.19
B-0616-FM4L	06	3/8	9.5	16x1.5	10	46.8	20.0	19	0.21
B-0618-FM4L	06	3/8	9.5	18x1.5	12	46.8	19.5	22	0.23
B-0822-FM4L	08	1/2	12.7	22x1.5	15	55.0	21.0	27	0.35
B-1026-FM4L	10	5/8	15.9	26x1.5	18	65.3	24.0	32	0.50
B-1230-FM4L	12	3/4	19.0	30x2.0	22	69.4	32.0	36	0.69
B-1636-FM4L	16	1	25.4	36x2.0	28	91.4	32.0	41	1.09

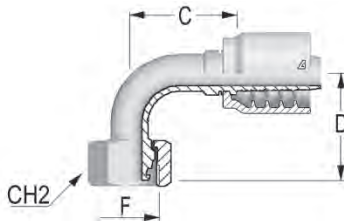

90° Metric Female 24° Cone with O-Ring - Light DIN 3865

Part Number	Dash Size	Hose ID Size		F Thread Dia x Pitch	Tube OD (mm)	C Cut-Off Factor (mm)	D Drop (mm)	CH2 (mm)	Weight (lbs/each)
		(in)	(mm)						
B-0412-FM9L	04	1/4	6.4	12x1.5	6	29.5	26.0	14	0.13
B-0414-FM9L	04	1/4	6.4	14x1.5	8	28.3	32.5	17	0.15
B-0416-FM9L	04	1/4	6.4	16x1.5	10	28.3	32.5	19	0.17
B-0418-FM9L	04	1/4	6.4	18x1.5	12	28.3	35.0	22	0.20
B-0516-FM9L	05	5/16	7.9	16x1.5	10	33.7	38.0	19	0.20
B-0616-FM9L	06	3/8	9.5	16x1.5	10	32.8	38.0	19	0.22
B-0618-FM9L	06	3/8	9.5	18x1.5	12	32.8	39.0	22	0.25
B-0822-FM9L	08	1/2	12.7	22x1.5	15	39.8	40.5	27	0.36
B-1026-FM9L	10	5/8	15.9	26x1.5	18	51.4	48.0	32	0.53
B-1030-FM9L	10	5/8	15.9	30x2.0	22	52.4	49.0	36	0.62
B-1230-FM9L	12	3/4	19.0	30x2.0	22	52.1	59.0	36	0.75
B-1636-FM9L	16	1	25.4	36x2.0	28	77.6	68.0	41	1.23

Because we continually examine ways to improve our products, we reserve the right to alter specifications or discontinue products without prior notice.

AlfaCrimp One-Piece Fittings - B Series



HOSES
ONE-PIECE B SERIES
ONE-PIECE D SERIES
ONE-PIECE F & P SERIES
TWO-PIECE FERRULES (A & PFR SERIES)
TWO-PIECE INSERTS (A SERIES)
TWO-PIECE INTERLOCK FERRULES & INSERTS (X & Z SERIES)
QUICK RELEASE
ASSEMBLY EQUIPMENT
TECHNICAL INFORMATION

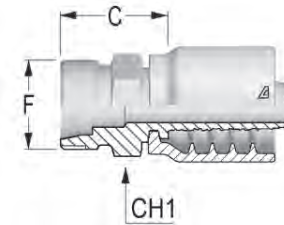

Metric Male 24° Seat - Heavy DIN 3853

Part Number	Dash Size	Hose ID Size		F Thread Dia x Pitch	Tube OD (mm)	C Cut-Off Factor (mm)	CH1 (mm)	Weight (lbs/each)
		(in)	(mm)					
B-0418-MMSH	04	1/4	6.4	18x1.5	10	25.3	19	0.15
B-0520-MMSH	05	5/16	7.9	20x1.5	12	25.3	22	0.18
B-0620-MMSH	06	3/8	9.5	20x1.5	12	25.3	22	0.19
B-0622-MMSH	06	3/8	9.5	22x1.5	14	27.3	22	0.21
B-0824-MMSH	08	1/2	12.7	24x1.5	16	29.1	24	0.27
B-1030-MMSH	10	5/8	15.9	30x2.0	20	33.1	32	0.41
B-1230-MMSH	12	3/4	19.0	30x2.0	20	37.6	36	0.49
B-1236-MMSH	12	3/4	19.0	36x2.0	25	33.6	32	0.60
B-1642-MMSH	16	1	25.4	42x2.0	30	42.4	46	0.98

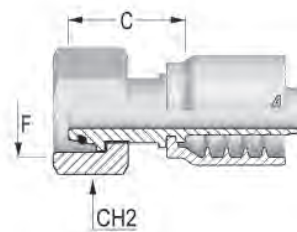

Metric Female 24° Cone with O-Ring - Heavy DIN 3865

Part Number	Dash Size	Hose ID Size		F Thread Dia x Pitch	Tube OD (mm)	C Cut-Off Factor (mm)	CH2 (mm)	Weight (lbs/each)
		(in)	(mm)					
B-0416-FMOH	04	1/4	6.4	16x1.5	8	27.7	19	0.15
B-0418-FMOH	04	1/4	6.4	18x1.5	10	27.6	22	0.19
B-0520-FMOH	05	5/16	7.9	20x1.5	12	27.6	24	0.21
B-0618-FMOH	06	3/8	9.5	18x1.5	10	27.6	22	0.21
B-0620-FMOH	06	3/8	9.5	20x1.5	12	27.6	24	0.23
B-0622-FMOH	06	3/8	9.5	22x1.5	14	31.1	27	0.30
B-0820-FMOH	08	1/2	12.7	20x1.5	12	31.9	24	0.27
B-0824-FMOH	08	1/2	12.7	24x1.5	16	31.7	30	0.37
B-1030-FMOH	10	5/8	15.9	30x2.0	20	36.5	36	0.56
B-1230-FMOH	12	3/4	19.0	30x2.0	20	37.0	36	0.65
B-1236-FMOH	12	3/4	19.0	36x2.0	25	39.6	46	0.94
B-1636-FMOH	16	1	25.4	36x2.0	25	41.0	46	1.06
B-1642-FMOH	16	1	25.4	42x2.0	30	43.1	50	1.20

Because we continually examine ways to improve our products, we reserve the right to alter specifications or discontinue products without prior notice.



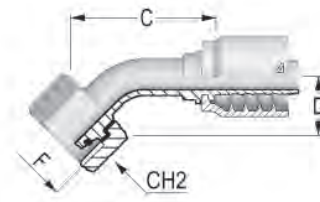

45° Metric Female 24° Cone with O-Ring - Heavy DIN 3865

Part Number	Dash Size	Hose ID Size		F Thread Dia x Pitch	Tube OD (mm)	C Cut-Off Factor (mm)	D Drop (mm)	CH2 (mm)	Weight (lbs/each)
		(in)	(mm)						
B-0416-FM4H	04	1/4	6.4	16x1.5	8	48.6	16.0	19	0.17
B-0418-FM4H	04	1/4	6.4	18x1.5	10	43.5	19.0	22	0.21
B-0520-FM4H	05	5/16	7.9	20x1.5	12	48.1	21.0	24	0.25
B-0620-FM4H	06	3/8	9.5	20x1.5	12	50.6	20.0	24	0.26
B-0622-FM4H	06	3/8	9.5	22x1.5	14	52.9	21.0	27	0.32
B-0824-FM4H	08	1/2	12.7	24x1.5	16	55.8	21.5	30	0.41
B-1030-FM4H	10	5/8	15.9	30x2.0	20	66.3	30.0	36	0.65
B-1236-FM4H	12	3/4	19.0	36x2.0	25	69.5	33.0	46	1.06
B-1642-FM4H	16	1	25.4	42x2.0	30	110.3	40.5	50	1.60

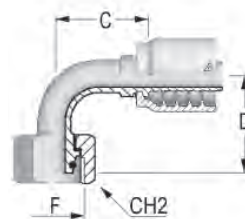

90° Metric Female 24° Cone with O-Ring - Heavy DIN 3865

Part Number	Dash Size	Hose ID Size		F Thread Dia x Pitch	Tube OD (mm)	C Cut-Off Factor (mm)	D Drop (mm)	CH2 (mm)	Weight (lbs/each)
		(in)	(mm)						
B-0416-FM9H	04	1/4	6.4	16x1.5	8	27.3	33.0	19	0.17
B-0418-FM9H	04	1/4	6.4	18x1.5	10	26.8	34.0	22	0.20
B-0520-FM9H	05	5/16	7.9	20x1.5	12	33.2	39.0	24	0.27
B-0618-FM9H	06	3/8	9.5	18x1.5	10	34.3	38.5	24	0.27
B-0620-FM9H	06	3/8	9.5	20x1.5	12	34.3	38.5	24	0.28
B-0622-FM9H	06	3/8	9.5	22x1.5	14	34.3	40.5	27	0.33
B-0824-FM9H	08	1/2	12.7	24x1.5	16	39.8	41.5	30	0.42
B-1030-FM9H	10	5/8	15.9	30x2.0	20	47.9	55.0	36	0.68
B-1230-FM9H	12	3/4	19.0	30x2.0	20	50.6	58.0	36	0.84
B-1236-FM9H	12	3/4	19.0	36x2.0	25	50.6	59.5	46	1.14
B-1642-FM9H	16	1	25.4	42x2.0	30	75.6	79.0	50	1.65

Because we continually examine ways to improve our products, we reserve the right to alter specifications or discontinue products without prior notice.

AlfaCrimp One-Piece Fittings - B Series



HOSES
ONE-PIECE B SERIES
ONE-PIECE D SERIES
ONE-PIECE F & P SERIES
TWO-PIECE FERRULES (A & PFR SERIES)
TWO-PIECE INSERTS (A SERIES)
TWO-PIECE INTERLOCK FERRULES & INSERTS (X & Z SERIES)
QUICK RELEASE
ASSEMBLY EQUIPMENT
TECHNICAL INFORMATION

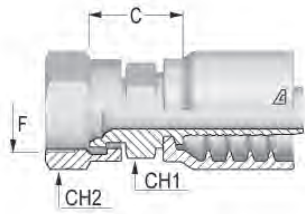

Komatsu Female

Part Number	Dash Size	Hose ID Size		F Thread		C Cut-Off Factor (mm)	CH1 (mm)	CH2 (mm)	Weight (lbs/each)
		(in)	(mm)	Dash Size	Size (in) - TPI				
B-0414-FKOS	04	1/4	6.4	14	14x1.5	20.8	17	19	0.17
B-0618-FKOS	06	3/8	9.5	18	18x1.5	21.8	19	22	0.21
B-0822-FKOS	08	1/2	12.7	22	22x1.5	23.6	22	27	0.31
B-1024-FKOS	10	5/8	15.9	24	24x1.5	27.1	30	32	0.51
B-1230-FKOS	12	3/4	19.0	30	30x1.5	27.6	30	36	0.61
B-1633-FKOS	16	1	25.4	33	33x1.5	35.7	36	41	1.01

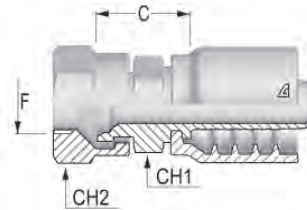

JIS Female 60° Seat Flare B 8363 (type F)

Part Number	Dash Size	Hose ID Size		F Thread		C Cut-Off Factor (mm)	CH1 (mm)	CH2 (mm)	Weight (lbs/each)
		(in)	(mm)	Dash Size	Size (in) - TPI				
B-0404-FJIS	04	1/4	6.4	04	1/4-19	20.8	17	19	0.16
B-0606-FJIS	06	3/8	9.5	06	3/8-19	21.8	19	22	0.21
B-0808-FJIS	08	1/2	12.7	08	1/2-14	23.6	22	27	0.31
B-1212-FJIS	12	3/4	19.0	12	3/4-14	27.1	30	36	0.58
B-1616-FJIS	16	1	25.4	16	1-11	32.9	36	41	0.87

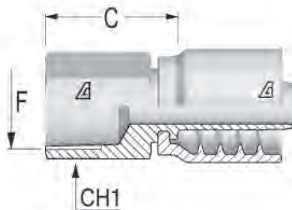

Female Grease Tap

Part Number	Dash Size	Hose ID Size		F Thread Size (in)	C Cut-Off Factor (mm)	Hex Dia. CH2 (mm)	Weight (lbs/each)
		(in)	(mm)				
B-0404-FGRT	04	1/4	6.4	1/2-27	23.3	19	0.07

Because we continually examine ways to improve our products, we reserve the right to alter specifications or discontinue products without prior notice.



One-Piece AlfaCrimp D Series Fittings Index

HOSES
ONE-PIECE B SERIES
ONE-PIECE D SERIES
ONE-PIECE F & P SERIES
TWO-PIECE FERRULES (A & PFR SERIES)
TWO-PIECE INSERTS (A SERIES)
TWO-PIECE INTERLOCK FERRULES & INSERTS (X & Z SERIES)
QUICK RELEASE
ASSEMBLY EQUIPMENT
TECHNICAL INFORMATION

NPTF



NPTF Male 60° Seat 116



NPTF Male Swivel 60° Seat 116



NPTF Female Rigid 117



NPSM Female 117



API Male 116

JIC



JIC Male 37° 119



JIC Female Swivel 37° Seat
Dual Hex 119-120



45° JIC Female Swivel 37°
Seat 120



90° JIC Female Swivel 37°
Seat Short Drop 121



90° JIC Female Swivel 37°
Seat Medium Drop 121



90° JIC Female Swivel 37°
Seat Long Drop 122

SAE



SAE Male O-Ring Boss 118



SAE Female Swivel 45° Seat 118

ORFS



ORFS Male 122



ORFS Female 123



45° ORFS Female 123



90° ORFS Female ISO 12151-1
Short Drop 124



90° ORFS Female ISO 12151-1
Medium Drop 124



90° ORFS Female ISO 12151-1
Long Drop 125

SAE Flange Code 61



O-Ring Flange SAE J518 Code 61
Straight 125



22° O-Ring Flange SAE J518 Code
61 126



30° O-Ring Flange SAE J518 Code
61 126



45° O-Ring Flange SAE J518 Code
61 127

Because we continually examine ways to improve our products, we reserve the right to alter specifications or discontinue products without prior notice.

One-Piece AlfaCrimp D Series Fittings Index

 **60° O-Ring Flange SAE J518 Code 61** 127

 **90° O-Ring Flange SAE J518 Code 61** 128

SAE Flange Code 62

 **Flange 6000 PSI SAE J518 Code 62** 128

 **45° Flange 6000 PSI SAE J518 Code 62** 129

 **90° Flange 6000 PSI SAE J518 Code 62** 129

BSP

 **BSP/JIS Male Tapered**.....130

 **BSP Male Parallel 60° Seat**130

 **BSP O-Ring Female Swivel 60° Cone** 131

 **45° BSP O-Ring Female Swivel 60° Cone** 132

 **90° BSP O-Ring Female Swivel 60° Cone** 133

Metric

 **Metric Male 24° Seat DIN 3853 – Light**134

 **Metric Male 24° Seat DIN 3861 – Heavy** 136

 **Metric Swivel Female O-Ring 24° Seat DIN 3865 – Light** 134

 **Metric Swivel Female O-Ring 24° Seat DIN 3865 – Heavy**136

 **45° Metric O-Ring Female Swivel 24° Seat DIN 3865 – Light** 135

 **45° Metric O-Ring Female Swivel 24° Seat DIN 3865 – Heavy** 137

 **90° Metric O-Ring Female Swivel 24° Seat DIN 3865 – Light**..... 135

 **90° Metric O-Ring Female Swivel 24° Seat DIN 3865 – Heavy** 137

HOSES

ONE-PIECE
B SERIES

ONE-PIECE
D SERIES

ONE-PIECE
F & P SERIES

TWO-PIECE FERRULES
(A & PFR SERIES)

TWO-PIECE INSERTS
(A-SERIES)

TWO-PIECE INTERLOCK
FERRULES & INSERTS
(X & Z-SERIES)

QUICK
RELEASE

ASSEMBLY
EQUIPMENT

TECHNICAL
INFORMATION

Because we continually examine ways to improve our products, we reserve the right to alter specifications or discontinue products without prior notice.

AlfaCrimp One-Piece Fittings - D Series



HOSES
ONE-PIECE B SERIES
ONE-PIECE D SERIES
ONE-PIECE F & P SERIES
TWO-PIECE FERRULES (A & PFR SERIES)
TWO-PIECE INSERTS (A SERIES)
TWO-PIECE INTERLOCK FERRULES & INSERTS (X & Z SERIES)
QUICK RELEASE
ASSEMBLY EQUIPMENT
TECHNICAL INFORMATION

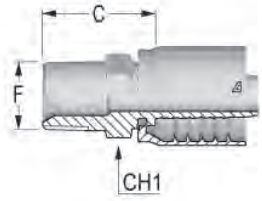

NPTF Male 60° Seat

Part Number	Dash Size	Hose ID Size		F Thread		C Cut-Off Factor (mm)	CH1 (mm)	Weight (lbs/each)
		(in)	(mm)	Dash Size	Size (in) - TPI			
D-0604-MNPT	06	3/8	9.5	04	1/4-18	26.8	17	0.18
D-0606-MNPT	06	3/8	9.5	06	3/8-18	27.8	19	0.20
D-0608-MNPT	06	3/8	9.5	08	1/2-14	31.3	22	0.27
D-0806-MNPT	08	1/2	12.7	06	3/8-18	28.6	19	0.25
D-0808-MNPT	08	1/2	12.7	08	1/2-14	32.1	22	0.31
D-0812-MNPT	08	1/2	12.7	12	3/4-14	34.1	27	0.36
D-1012-MNPT	10	5/8	15.9	12	3/4-14	34.1	27	0.40
D-1212-MNPT	12	3/4	19.0	12	3/4-14	34.6	27	0.50
D-1216-MNPT	12	3/4	19.0	16	1-11 1/2	43.6	36	0.70
D-1616-MNPT	16	1	25.4	16	1-11 1/2	44.4	36	0.97
D-1620-MNPT	16	1	25.4	20	1 1/4-11 1/2	47.4	46	1.23
D-2020-MNPT	20	1 1/4	31.8	20	1 1/4-11 1/2	49.0	46	1.40
D-2024-MNPT	20	1 1/4	31.8	24	1 1/2-11 1/2	50.5	50	1.53
D-2424-MNPT	24	1 1/2	38.1	24	1 1/2-11 1/2	50.5	50	1.79
D-3232-MNPT	32	2	50.8	32	2-11 1/2	54.2	65	2.69

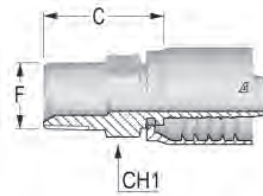

API Male

Part Number	Dash Size	Hose ID Size		F Thread		C Cut-Off Factor (mm)	CH1 (mm)	Weight (lbs/each)
		(in)	(mm)	Dash Size	Size (in) - TPI			
D-2424-MAPI	24	1 1/2	38.1	24	1 1/2-11 1/2	80.3	50	2.50

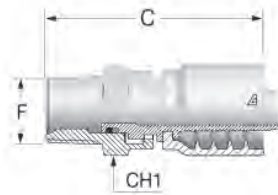

NPTF Male Swivel 60° Seat

Part Number	Dash Size	Hose ID Size		F Thread		C Cut-Off Factor (mm)	CH1 (mm)	Weight (lbs/each)
		(in)	(mm)	Dash Size	Size (in) - TPI			
D-1212-MNPS	12	3/4	19.0	12	3/4-14	50.1	32	0.55
D-1616-MNPS	16	1	25.4	16	1-11 1/2	57.9	41	1.06

Because we continually examine ways to improve our products, we reserve the right to alter specifications or discontinue products without prior notice.



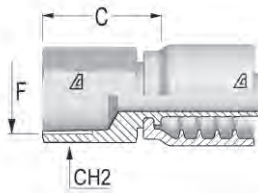

NPTF Female Rigid

Part Number	Dash Size	Hose ID Size		F Thread		C Cut-Off Factor (mm)	CH2 (mm)	Weight (lbs/each)
		(in)	(mm)	Dash Size	Size (in) - TPI			
D-1212-FNPR	12	3/4	19.0	12	3/4-14	38.1	32	0.58
D-1616-FNPR	16	1	25.4	16	1-11 1/2	44.9	38	1.01

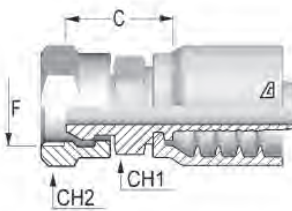

NPSM Female

Part Number	Dash Size	Hose ID Size		F Thread		C Cut-Off Factor (mm)	CH1 (mm)	CH2 (mm)	Weight (lbs/each)
		(in)	(mm)	Dash Size	Size (in) - TPI				
D-1212-FPMS	12	3/4	19.0	12	3/4-14	28.6	32	32	0.61
D-1616-FPMS	16	1	25.4	16	1-11 1/2	35.4	38	36	1.02

Because we continually examine ways to improve our products, we reserve the right to alter specifications or discontinue products without prior notice.

AlfaCrimp One-Piece Fittings - D Series



HOSES

ONE-PIECE B SERIES

ONE-PIECE D SERIES

ONE-PIECE F & P SERIES

TWO-PIECE FERRULES (A & PFR SERIES)

TWO-PIECE INSERTS (A SERIES)

TWO-PIECE INTERLOCK FERRULES & INSERTS (X & Z SERIES)

QUICK RELEASE

ASSEMBLY EQUIPMENT

TECHNICAL INFORMATION

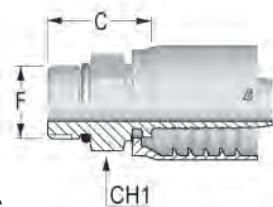

SAE Male O-Ring Boss

Part Number	Dash Size	Hose ID Size		F Thread		C Cut-Off Factor (mm)	CH1 (mm)	Weight (lbs/each)
		(in)	(mm)	Dash Size	Size (in) - TPI			
D-0606-MORB	06	3/8	9.5	06	9/16-18	23.3	19	0.19
D-0608-MORB	06	3/8	9.5	08	3/4-16	24.3	22	0.23
D-0610-MORB	06	3/8	9.5	10	7/8-14	26.8	27	0.27
D-0808-MORB	08	1/2	12.7	08	3/4-16	25.1	22	0.28
D-0810-MORB	08	1/2	12.7	10	7/8-14	27.6	27	0.36
D-0812-MORB	08	1/2	12.7	12	1 1/16-12	32.1	32	0.36
D-1210-MORB	12	3/4	19.0	10	7/8-14	28.1	27	0.48
D-1212-MORB	12	3/4	19.0	12	1 1/16-12	32.6	32	0.55
D-1216-MORB	12	3/4	19.0	16	1 5/16-12	34.6	38	0.68
D-1616-MORB	16	1	25.4	16	1 5/16-12	35.4	38	0.98

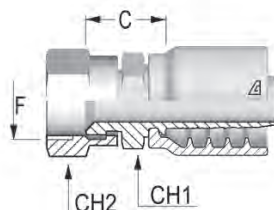

SAE Female Swivel 45° Seat

Part Number	Dash Size	Hose ID Size		F Thread		C Cut-Off Factor (mm)	CH1 (mm)	CH2 (mm)	Weight (lbs/each)
		(in)	(mm)	Dash Size	Size (in) - TPI				
D-1212-FSAE	12	3/4	19.0	12	1 1/16-14	29.6	32	27	0.59

continued on the next page

Because we continually examine ways to improve our products, we reserve the right to alter specifications or discontinue products without prior notice.



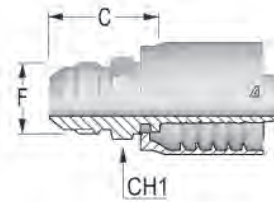

JIC Male 37°

Part Number	Dash Size	Hose ID Size		F Thread		C Cut-Off Factor (mm)	CH1 (mm)	Weight (lbs/each)
		(in)	(mm)	Dash Size	Size (in) - TPI			
D-0606-MJIC	06	3/8	9.5	06	9/16-18	26.3	17	0.18
D-0608-MJIC	06	3/8	9.5	08	3/4-16	29.8	19	0.22
D-0808-MJIC	08	1/2	12.7	08	3/4-16	30.6	19	0.25
D-0810-MJIC	08	1/2	12.7	10	7/8-14	34.6	24	0.30
D-0812-MJIC	08	1/2	12.7	12	1 1/16-12	37.1	27	0.36
D-1010-MJIC	10	5/8	15.9	10	7/8-14	34.6	24	0.36
D-1012-MJIC	10	5/8	15.9	12	1 1/16-12	37.1	27	0.41
D-1212-MJIC	12	3/4	19.0	12	1 1/16-12	37.6	27	0.51
D-1214-MJIC	12	3/4	19.0	14	1 3/16-12	40.1	32	0.60
D-1216-MJIC	12	3/4	19.0	16	1 5/16-12	42.6	36	0.78
D-1616-MJIC	16	1	25.4	16	1 5/16-12	43.4	36	0.94
D-1620-MJIC	16	1	25.4	20	1 5/8-12	46.9	46	1.21
D-2020-MJIC	20	1 1/4	31.8	20	1 5/8-12	48.5	46	1.39
D-2024-MJIC	20	1 1/4	31.8	24	1 7/8-12	53.0	50	1.63
D-2424-MJIC	24	1 1/2	38.1	24	1 7/8-12	52.5	50	1.85
D-3232-MJIC	32	2	50.8	32	2 1/2-12	60.0	60	3.13

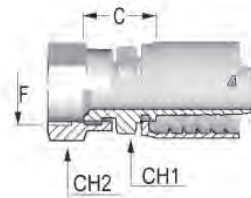

JIC Female Swivel 37° Seat Dual Hex

Part Number	Dash Size	Hose ID Size		F Thread		C Cut-Off Factor (mm)	CH1 (mm)	CH2 (mm)	Weight (lbs/each)
		(in)	(mm)	Dash Size	Size (in) - TPI				
D-0606-FJDH	06	3/8	9.5	06	9/16-18	21.3	17	19	0.21
D-0608-FJDH	06	3/8	9.5	08	3/4-16	24.8	19	25	0.28
D-0806-FJDH	08	1/2	12.7	06	9/16-18	23.1	19	19	0.34
D-0808-FJDH	08	1/2	12.7	08	3/4-16	25.6	19	25	0.29
D-0810-FJDH	08	1/2	12.7	10	7/8-14	26.6	22	27	0.36
D-0812-FJDH	08	1/2	12.7	12	1 1/16-12	28.1	25	32	0.44
D-1010-FJDH	10	5/8	15.9	10	7/8-14	27.6	24	27	0.45
D-1210-FJDH	12	3/4	19.0	10	7/8-14	29.1	27	27	0.55
D-1212-FJDH	12	3/4	19.0	12	1 1/16-12	28.6	27	32	0.59

Because we continually examine ways to improve our products, we reserve the right to alter specifications or discontinue products without prior notice.

AlfaCrimp One-Piece Fittings - D Series



HOSES
ONE-PIECE B SERIES
ONE-PIECE D SERIES
ONE-PIECE F & P SERIES
TWO-PIECE FERRULES (A & PFR SERIES)
TWO-PIECE INSERTS (A SERIES)
TWO-PIECE INTERLOCK FERRULES & INSERTS (X & Z SERIES)
QUICK RELEASE
ASSEMBLY EQUIPMENT
TECHNICAL INFORMATION

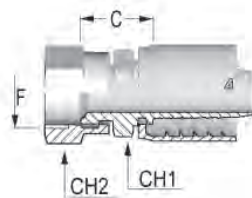

(continued)

JIC Female Swivel 37° Seat Dual Hex

Part Number	Dash Size	Hose ID Size		F Thread		C Cut-Off Factor (mm)	CH1 (mm)	CH2 (mm)	Weight (lbs/each)
		(in)	(mm)	Dash Size	Size (in) - TPI				
D-1214-FJDH	12	3/4	19.0	14	1 3/16-12	26.8	27	22	0.68
D-1216-FJDH	12	3/4	19.0	16	1 5/16-12	32.1	32	38	0.73
D-1612-FJDH	16	1	25.4	12	1 1/16-12	31.4	32	32	0.98
D-1616-FJDH	16	1	25.4	16	1 5/16-12	32.9	32	38	1.06
D-2020-FJDH	20	1 1/4	31.8	20	1 5/8-12	39.1	41	50	1.45
D-2424-FJDH	24	1 1/2	38.1	24	1 7/8-12	43.4	50	55	2.45
D-3232-FJDH	32	2	50.8	32	2 1/2-12	49.0	65	70	3.24

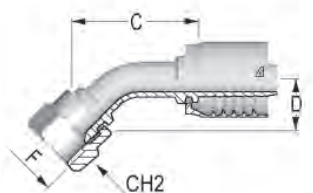

45° JIC Female Swivel 37° Seat

Part Number	Dash Size	Hose ID Size		F Thread		C Cut-Off Factor (mm)	D Drop (mm)	CH2 (mm)	Weight (lbs/each)
		(in)	(mm)	Dash Size	Size (in) - TPI				
D-0606-FJ45	06	3/8	9.5	06	9/16-18	46.3	11.0	19	0.24
D-0608-FJ45	06	3/8	9.5	08	3/4-16	47.2	15.0	25	0.30
D-0808-FJ45	08	1/2	12.7	08	3/4-16	51.6	15.0	25	0.37
D-0810-FJ45	08	1/2	12.7	10	7/8-14	50.7	16.0	27	0.40
D-0812-FJ45	08	1/2	12.7	12	1 1/16-12	57.0	21.0	32	0.53
D-1010-FJ45	10	5/8	15.9	10	7/8-14	62.2	19.0	27	0.57
D-1012-FJ45	10	5/8	15.9	12	1 1/16-12	68.6	21.0	32	0.56
D-1212-FJ45	12	3/4	19.0	12	1 1/16-12	67.5	21.0	32	0.86
D-1214-FJ45	12	3/4	19.0	14	1 3/16-12	61.0	22.5	36	0.75
D-1216-FJ45	12	3/4	19.0	16	1 5/16-12	71.4	26.0	38	0.86
D-1616-FJ45	16	1	25.4	16	1 5/16-12	79.4	24.0	38	1.31
D-1620-FJ45	16	1	25.4	20	1 5/8-12	83.8	37.0	50	1.71
D-2020-FJ45	20	1 1/4	31.8	20	1 5/8-12	97.1	37.0	50	2.06
D-2024-FJ45	20	1 1/4	31.8	24	1 7/8-12	107.0	42.0	55	2.24
D-2424-FJ45	24	1 1/2	38.1	24	1 7/8-12	112.7	43.0	55	2.67
D-3232-FJ45	32	2	50.8	32	2 1/2-12	159.9	67.0	70	3.48

Because we continually examine ways to improve our products, we reserve the right to alter specifications or discontinue products without prior notice.



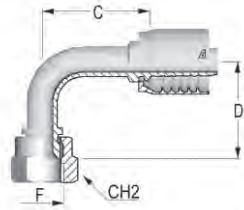

90° JIC Female Swivel 37° Seat Short Drop

Part Number	Dash Size	Hose ID Size		F Thread		C Cut-Off Factor (mm)	D Drop (mm)	CH2 (mm)	Weight (lbs/each)
		(in)	(mm)	Dash Size	Size (in) - TPI				
D-0606-FJ9S	06	3/8	9.5	06	9/16-18	32.5	23.0	19	0.22
D-0608-FJ9S	06	3/8	9.5	08	3/4-16	32.5	28.0	25	0.29
D-0808-FJ9S	08	1/2	12.7	08	3/4-16	37.0	29.0	25	0.39
D-0810-FJ9S	08	1/2	12.7	10	7/8-14	38.0	32.0	27	0.41
D-0812-FJ9S	08	1/2	12.7	12	1 1/16-12	37.3	46.0	32	0.52
D-1010-FJ9S	10	5/8	15.9	10	7/8-14	49.0	32.0	27	0.59
D-1012-FJ9S	10	5/8	15.9	12	1 1/16-12	48.0	48.0	32	0.64
D-1212-FJ9S	12	3/4	19.0	12	1 1/16-12	58.2	46.0	32	0.86
D-1216-FJ9S	12	3/4	19.0	16	1 1/16-12	53.6	53.0	38	0.96
D-1616-FJ9S	16	1	25.4	16	1 5/16-12	74.0	56.0	38	1.32

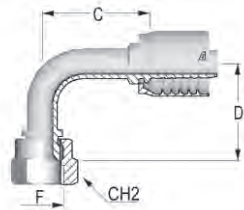

90° JIC Female Swivel 37° Seat Medium Drop

Part Number	Dash Size	Hose ID Size		F Thread		C Cut-Off Factor (mm)	D Drop (mm)	CH2 (mm)	Weight (lbs/each)
		(in)	(mm)	Dash Size	Size (in) - TPI				
D-0606-FJ9M	06	3/8	9.5	06	9/16-18	31.3	35.0	19	0.24
D-0608-FJ9M	06	3/8	9.5	08	3/4-16	39.5	41.0	25	0.31
D-0808-FJ9M	08	1/2	12.7	08	3/4-16	37.2	40.0	25	0.40
D-0810-FJ9M	08	1/2	12.7	10	7/8-14	43.3	47.0	27	0.44
D-0812-FJ9M	08	1/2	12.7	12	1 1/16-12	42.8	58.0	32	0.49
D-1010-FJ9M	10	5/8	15.9	10	7/8-14	49.4	48.0	27	0.58
D-1012-FJ9M	10	5/8	15.9	12	1 1/16-12	47.9	58.0	32	0.66
D-1212-FJ9M	12	3/4	19.0	12	1 1/16-12	52.4	54.0	32	0.91
D-1214-FJ9M	12	3/4	19.0	14	1 3/16-12	52.6	56.0	36	0.95
D-1216-FJ9M	12	3/4	19.0	16	1 5/16-12	52.6	72.0	38	1.03
D-1616-FJ9M	16	1	25.4	16	1 5/16-12	72.6	71.5	38	1.45
D-1620-FJ9M	16	1	25.4	20	1 5/8-12	72.6	78.0	50	1.91
D-2020-FJ9M	20	1 1/4	31.8	20	1 5/8-12	82.4	78.0	50	2.32
D-2024-FJ9M	20	1 1/4	31.8	24	1 7/8-12	87.3	82.0	55	2.64
D-2424-FJ9M	24	1 1/2	38.1	24	1 7/8-12	95.3	92.0	55	2.67
D-3232-FJ9M	32	2	50.8	32	2 1/2-12	129.5	140.0	70	3.48

Because we continually examine ways to improve our products, we reserve the right to alter specifications or discontinue products without prior notice.

AlfaCrimp One-Piece Fittings - D Series



HOSES

ONE-PIECE B SERIES

ONE-PIECE D SERIES

ONE-PIECE F & P SERIES

TWO-PIECE FERRULES (A & PFR SERIES)

TWO-PIECE INSERTS (A SERIES)

TWO-PIECE INTERLOCK FERRULES & INSERTS (X & Z SERIES)

QUICK RELEASE

ASSEMBLY EQUIPMENT

TECHNICAL INFORMATION

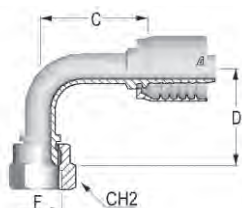

90° JIC Female Swivel 37° Seat Long Drop

Part Number	Dash Size	Hose ID Size		F Thread		C Cut-Off Factor (mm)	D Drop (mm)	CH2 (mm)	Weight (lbs/each)
		(in)	(mm)	Dash Size	Size (in) - TPI				
D-0606-FJ9L	06	3/8	9.5	06	9/16-18	43.3	54.0	19	0.28
D-0608-FJ9L	06	3/8	9.5	08	3/4-16	46.8	64.0	25	0.34
D-0808-FJ9L	08	1/2	12.7	08	3/4-16	49.9	64.0	25	0.45
D-0810-FJ9L	08	1/2	12.7	10	7/8-14	37.3	65.0	27	0.46
D-0812-FJ9L	08	1/2	12.7	12	1 1/16-12	38.5	62.0	41	0.48
D-1010-FJ9L	10	5/8	15.9	10	7/8-14	49.9	65.0	27	0.62
D-1012-FJ9L	10	5/8	15.9	12	1 1/16-12	48.0	96.0	32	0.76
D-1212-FJ9L	12	3/4	19.0	12	1 1/16-12	54.1	95.0	32	1.00
D-1216-FJ9L	12	3/4	19.0	16	1 5/16-12	54.0	114.0	38	1.16
D-1616-FJ9L	16	1	25.4	16	1 5/16-12	78.6	114.0	38	1.76

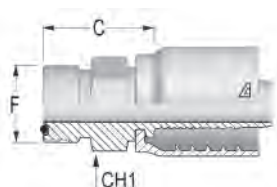

ORFS Male

Part Number	Dash Size	Hose ID Size		F Thread		C Cut-Off Factor (mm)	CH1 (mm)	Weight (lbs/each)
		(in)	(mm)	Dash Size	Size (in) - TPI			
D-0606-MOFS	06	3/8	9.5	06	11/16-16	24.3	19	0.20
D-0608-MOFS	06	3/8	9.5	08	13/16-16	26.3	22	0.22
D-0808-MOFS	08	1/2	12.7	08	13/16-16	27.1	22	0.30
D-0810-MOFS	08	1/2	12.7	10	1-14	30.6	27	0.36
D-0812-MOFS	08	1/2	12.7	12	1 3/16-12	37.1	32	0.38
D-1010-MOFS	10	5/8	15.9	10	1-14	30.6	27	0.41
D-1012-MOFS	10	5/8	15.9	12	1 3/16-12	32.1	32	0.48
D-1210-MOFS	12	3/4	19.0	10	1-14	31.1	32	0.51
D-1212-MOFS	12	3/4	19.0	12	1 3/16-12	34.6	32	0.63
D-1216-MOFS	12	3/4	19.0	16	1 7/16-12	38.1	41	0.81
D-1616-MOFS	16	1	25.4	16	1 7/16-12	37.9	38	1.04
D-1620-MOFS	16	1	25.4	20	1 11/16-12	39.9	46	1.21
D-2020-MOFS	20	1 1/4	31.8	20	1 11/16-12	41.5	46	1.54

Because we continually examine ways to improve our products, we reserve the right to alter specifications or discontinue products without prior notice.



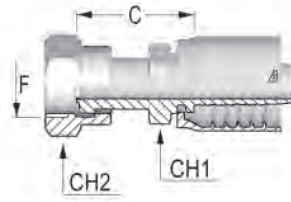

ORFS Female

Part Number	Dash Size	Hose ID Size		F Thread		C Cut-Off Factor (mm)	CH1 (mm)	CH2 (mm)	Weight (lbs/each)
		(in)	(mm)	Dash Size	Size (in) - TPI				
D-0606-FOFS	06	3/8	9.5	06	11/16-16	30.3	17	22	0.25
D-0608-FOFS	06	3/8	9.5	08	13/16-16	35.3	22	24	0.32
D-0808-FOFS	08	1/2	12.7	08	13/16-16	36.1	22	24	0.36
D-0810-FOFS	08	1/2	12.7	10	1-14	39.6	24	30	0.46
D-1010-FOFS	10	5/8	15.9	10	1-14	39.6	24	30	0.50
D-1012-FOFS	10	5/8	15.9	12	1 3/16-12	42.1	30	36	0.68
D-1210-FOFS	12	3/4	19.0	10	1-14	40.1	27	30	0.72
D-1212-FOFS	12	3/4	19.0	12	1 3/16-12	42.6	30	36	0.74
D-1216-FOFS	12	3/4	19.0	16	1 7/16-12	48.6	36	41	0.96
D-1612-FOFS	16	1	25.4	12	1 3/16-12	45.4	32	36	1.12
D-1616-FOFS	16	1	25.4	16	1 7/16-12	49.4	36	41	1.16
D-1620-FOFS	16	1	25.4	20	1 11/16-12	50.4	41	50	1.49
D-2020-FOFS	20	1 1/4	31.8	20	1 11/16-12	52.0	41	50	1.60
D-2424-FOFS	24	1 1/2	38.1	24	2-12	56.5	50	60	2.45

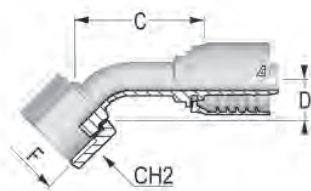

45° ORFS Female

Part Number	Dash Size	Hose ID Size		F Thread		C Cut-Off Factor (mm)	D Drop (mm)	CH2 (mm)	Weight (lbs/each)
		(in)	(mm)	Dash Size	Size (in) - TPI				
D-0606-F045	06	3/8	9.5	06	11/16-16	47.4	12.0	22	0.25
D-0608-F045	06	3/8	9.5	08	13/16-16	51.2	15.0	24	0.30
D-0808-F045	08	1/2	12.7	08	13/16-16	47.1	16.0	24	0.43
D-0810-F045	08	1/2	12.7	10	1-14	50.4	16.5	30	0.43
D-1010-F045	10	5/8	15.9	10	1-14	57.7	17.0	30	0.51
D-1012-F045	10	5/8	15.9	12	1 3/16-12	63.1	21.0	36	0.75
D-1212-F045	12	3/4	19.0	12	1 3/16-12	63.5	21.0	36	0.83
D-1216-F045	12	3/4	19.0	16	1 7/16-12	70.7	24.0	41	1.25
D-1616-F045	16	1	25.4	16	1 7/16-12	82.4	26.0	41	1.34
D-2020-F045	20	1 1/4	31.8	20	1 11/16-12	97.4	26.0	50	1.75
D-2424-F045	24	1 1/2	38.1	24	2-12	104.4	28.0	60	2.56

Because we continually examine ways to improve our products, we reserve the right to alter specifications or discontinue products without prior notice.

AlfaCrimp One-Piece Fittings - D Series



HOSES
ONE-PIECE B SERIES
ONE-PIECE D SERIES
ONE-PIECE F & P SERIES
TWO-PIECE FERRULES (A & PFR SERIES)
TWO-PIECE INSERTS (A SERIES)
TWO-PIECE INTERLOCK FERRULES & INSERTS (X & Z SERIES)
QUICK RELEASE
ASSEMBLY EQUIPMENT
TECHNICAL INFORMATION

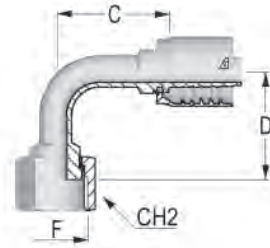

90° ORFS Female – ISO 12151-1 Short Drop

Part Number	Dash Size	Hose ID Size		F Thread		C Cut-Off Factor (mm)	D Drop (mm)	CH2 (mm)	Weight (lbs/each)
		(in)	(mm)	Dash Size	Size (in) - TPI				
D-0606-F09S	06	3/8	9.5	06	11/16-16	41.8	25.0	22	0.24
D-0608-F09S	06	3/8	9.5	08	13/16-16	35.0	29.0	24	0.28
D-0808-F09S	08	1/2	12.7	08	13/16-16	39.8	29.0	24	0.37
D-0810-F09S	08	1/2	12.7	10	1-14	46.3	32.5	30	0.45
D-1212-F09S	12	3/4	19.0	12	1 3/16-12	60.6	51.0	36	0.90
D-1216-F09S	12	3/4	19.0	16	1 7/16-12	50.0	56.0	41	1.08
D-1616-F09S	16	1	25.4	16	1 7/16-12	80.0	58.0	41	1.46
D-2020-F09S	20	1 1/4	31.8	20	1 11/16-12	95.0	68.0	50	2.21
D-2424-F09S	24	1 1/2	38.1	24	2-12	103.0	69.0	60	3.03

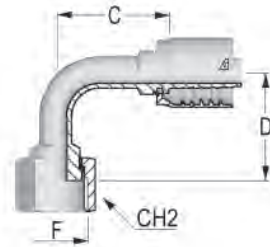

90° ORFS Female – ISO 12151-1 Medium Drop

Part Number	Dash Size	Hose ID Size		F Thread		C Cut-Off Factor (mm)	D Drop (mm)	CH2 (mm)	Weight (lbs/each)
		(in)	(mm)	Dash Size	Size (in) - TPI				
D-0606-F09M	06	3/8	9.5	06	11/16-16	41.8	38.0	22	0.25
D-0608-F09M	06	3/8	9.5	08	13/16-16	43.8	41.0	24	0.31
D-0808-F09M	08	1/2	12.7	08	13/16-16	34.8	42.0	24	0.38
D-0810-F09M	08	1/2	12.7	10	1-14	48.3	47.0	30	0.49
D-1010-F09M	10	5/8	15.9	10	1-14	55.4	44.0	30	0.60
D-1212-F09M	12	3/4	19.0	12	1 3/16-12	61.6	58.0	36	0.93
D-1216-F09M	12	3/4	19.0	16	1 7/16-12	65.6	71.0	41	1.08
D-1616-F09M	16	1	25.4	16	1 7/16-12	82.6	66.0	41	1.51
D-2020-F09M	20	1 1/4	31.8	20	1 11/16-12	97.0	78.0	50	2.28
D-2424-F09M	24	1 1/2	38.1	24	2-12	107.8	87.0	60	3.14

Because we continually examine ways to improve our products, we reserve the right to alter specifications or discontinue products without prior notice.



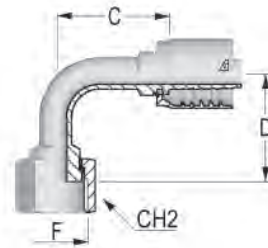

90° ORFS Female – ISO 12151-1 Long Drop

Part Number	Dash Size	Hose ID Size		F Thread		C Cut-Off Factor (mm)	D Drop (mm)	CH2 (mm)	Weight (lbs/each)
		(in)	(mm)	Dash Size	Size (in) - TPI				
D-0606-F09L	06	3/8	9.5	06	11/16-16	32.0	54.0	22	0.29
D-0608-F09L	06	3/8	9.5	08	13/16-16	35.0	64.0	24	0.34
D-0808-F09L	08	1/2	12.7	08	13/16-16	38.0	64.0	24	0.40
D-0810-F09L	08	1/2	12.7	10	1-14	37.0	70.0	30	0.53
D-1010-F09L	10	5/8	15.9	10	1-14	48.0	70.0	30	0.66
D-1212-F09L	12	3/4	19.0	12	1 3/16-12	50.0	96.0	36	1.03
D-1216-F09L	12	3/4	19.0	16	1 7/16-12	50.0	114.0	41	1.65
D-1616-F09L	16	1	25.4	16	1 7/16-12	70.5	114.0	41	1.71
D-2020-F09L	20	1 1/4	31.8	20	1 11/16-12	91.0	129.0	50	2.59
D-2424-F09L	24	1 1/2	38.1	24	2-12	103.0	141.0	60	3.59

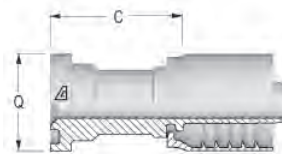

For Code 61 Split Flange Clamps, please refer to page 195.

O-Ring Flange SAE J518 Code 61 Straight

Part Number	Dash Size	Hose ID Size		Q Flange		C Cut-Off Factor (mm)	Max. Working Pressure (psi)	Weight (lbs/each)
		(in)	(mm)	(in)	(mm)			
D-0808-C61S	08	1/2	12.7	1.19	30.2	41.0	5000	0.39
D-0812-C61S	08	1/2	12.7	1.50	38.1	42.0	5000	0.49
D-1212-C61S	12	3/4	19.0	1.50	38.1	42.5	5000	0.66
D-1216-C61S	12	3/4	19.0	1.75	44.5	50.5	5000	0.80
D-1616-C61S	16	1	25.4	1.75	44.5	51.4	5000	1.18
D-1620-C61S	16	1	25.4	2.00	50.8	53.9	4000	1.21
D-2020-C61S	20	1 1/4	31.8	2.00	50.8	55.5	4000	1.43
D-2024-C61S	20	1 1/4	31.8	2.38	60.3	58.5	3000	1.61
D-2424-C61S	24	1 1/2	38.1	2.38	60.3	58.5	3000	2.56
D-2432-C61S	24	1 1/2	38.1	2.81	71.4	70.0	3000	3.10
D-3232-C61S	32	2	50.8	2.81	71.4	70.0	3000	4.41

Because we continually examine ways to improve our products, we reserve the right to alter specifications or discontinue products without prior notice.

AlfaCrimp One-Piece Fittings - D Series



HOSES

ONE-PIECE B SERIES

ONE-PIECE D SERIES

ONE-PIECE F & P SERIES

TWO-PIECE FERRULES (A & PFR SERIES)

TWO-PIECE INSERTS (A SERIES)

TWO-PIECE INTERLOCK FERRULES & INSERTS (X & Z SERIES)

QUICK RELEASE

ASSEMBLY EQUIPMENT

TECHNICAL INFORMATION

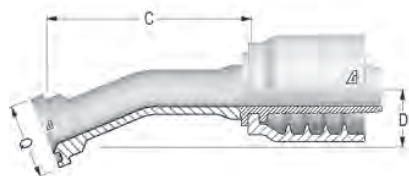

For Code 61 Split Flange Clamps, please refer to page 195.

22.5° O-Ring Flange SAE J518 Code 61

Part Number	Dash Size	Hose ID Size		Q Flange		C Cut-Off Factor (mm)	D Drop (mm)	Max. Working Pressure (psi)	Weight (lbs/each)
		(in)	(mm)	(in)	(mm)				
D-1616-C612	16	1	25.4	1.75	44.5	86.5	12.0	5000	1.45
D-2020-C612	20	1 1/4	31.8	2.00	50.8	114.0	13.0	4000	1.93
D-2024-C612	20	1 1/4	31.8	2.38	60.3	114.0	16.0	3000	2.18
D-2424-C612	24	1 1/2	38.1	2.38	60.3	133.5	16.5	3000	2.63

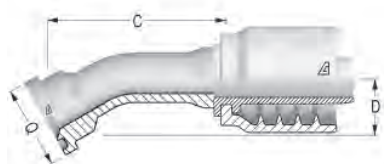

For Code 61 Split Flange Clamps, please refer to page 195.

30° O-Ring Flange SAE J518 Code 61

Part Number	Dash Size	Hose ID Size		Q Flange		C Cut-Off Factor (mm)	D Drop (mm)	Max. Working Pressure (psi)	Weight (lbs/each)
		(in)	(mm)	(in)	(mm)				
D-1212-C613	12	3/4	19.0	1.50	38.1	77.5	19	5000	0.84
D-1216-C613	12	3/4	19.0	1.75	44.5	114.0	13	5000	0.97
D-1616-C613	16	1	25.4	1.75	44.5	90.0	20	5000	1.27
D-1620-C613	16	1	25.4	2.00	50.8	89.0	22	4000	1.36
D-2020-C613	20	1 1/4	31.8	2.00	50.8	89.0	22	4000	1.74
D-2024-C613	20	1 1/4	31.8	2.38	60.3	104.0	19	3000	1.85
D-2432-C613	24	1 1/2	38.1	2.81	71.4	145.0	35	3000	3.38

Because we continually examine ways to improve our products, we reserve the right to alter specifications or discontinue products without prior notice.



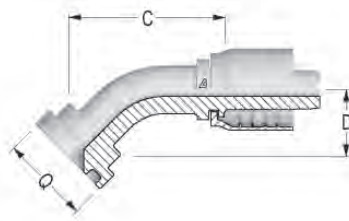

For Code 61 Split Flange Clamps, please refer to page 195.

45° O-Ring Flange SAE J518 Code 61

Part Number	Dash Size	Hose ID Size		Q Flange		C Cut-Off Factor (mm)	D Drop (mm)	Max. Working Pressure (psi)	Weight (lbs/each)
		(in)	(mm)	(in)	(mm)				
D-0808-C614	08	1/2	12.7	1.19	30.2	43.7	22.0	5000	0.40
D-0812-C614	08	1/2	12.7	1.50	38.1	50.4	26.0	5000	0.51
D-1212-C614	12	3/4	19.0	1.50	38.1	63.8	32.0	5000	0.73
D-1216-C614	12	3/4	19.0	1.75	44.5	68.0	29.0	5000	0.83
D-1616-C614	16	1	25.4	1.75	44.5	72.8	33.5	5000	1.28
D-1620-C614	16	1	25.4	2.00	50.8	97.0	36.0	4000	1.36
D-2020-C614	20	1 1/4	31.8	2.00	50.8	85.2	37.5	4000	1.63
D-2024-C614	20	1 1/4	31.8	2.38	60.3	92.8	40.0	3000	1.77
D-2424-C614	24	1 1/2	38.1	2.38	60.3	105.4	48.0	3000	2.56
D-2432-C614	24	1 1/2	38.1	2.81	71.4	124.3	55.5	3000	3.10
D-3232-C614	32	2	50.8	2.81	71.4	129.5	47.5	3000	4.41

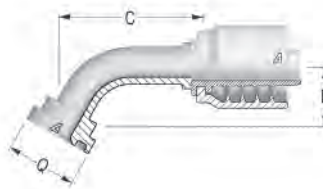

For Code 61 Split Flange Clamps, please refer to page 195.

60° O-Ring Flange SAE J518 Code 61

Part Number	Dash Size	Hose ID Size		Q Flange		C Cut-Off Factor (mm)	D Drop (mm)	Max. Working Pressure (psi)	Weight (lbs/each)
		(in)	(mm)	(in)	(mm)				
D-1212-C616	12	3/4	19.0	1.50	38.1	86.0	37.0	5000	0.80
D-1216-C616	12	3/4	19.0	1.75	44.5	95.0	43.0	5000	1.10
D-1616-C616	16	1	25.4	1.75	44.5	101.0	47.0	5000	1.47
D-1620-C616	16	1	25.4	2.00	50.8	105.5	43.5	4000	1.58
D-2020-C616	20	1 1/4	31.8	2.00	50.8	129.5	56.5	4000	2.18
D-2424-C616	24	1 1/2	38.1	2.38	60.3	138.0	66.0	3000	2.95
D-3232-C616	32	2	50.8	2.81	71.4	155.0	92.0	3000	5.90

Because we continually examine ways to improve our products, we reserve the right to alter specifications or discontinue products without prior notice.

AlfaCrimp One-Piece Fittings - D Series



HOSES

ONE-PIECE B SERIES

ONE-PIECE D SERIES

ONE-PIECE F & P SERIES

TWO-PIECE FERRULES (A & PFR SERIES)

TWO-PIECE INSERTS (A SERIES)

TWO-PIECE INTERLOCK FERRULES & INSERTS (X & Z SERIES)

QUICK RELEASE

ASSEMBLY EQUIPMENT

TECHNICAL INFORMATION

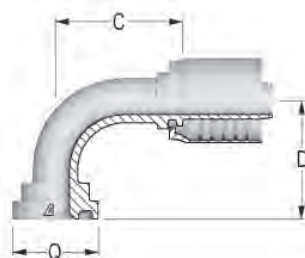

For Code 61 Split Flange Clamps, please refer to page 195.

90° O-Ring Flange SAE J518 Code 61

Part Number	Dash Size	Hose ID Size		Q Flange		C Cut-Off Factor (mm)	D Drop (mm)	Max. Working Pressure (psi)	Weight (lbs/each)
		(in)	(mm)	(in)	(mm)				
D-0808-C619	08	1/2	12.7	1.19	30.2	45.8	42.0	5000	0.56
D-0812-C619	08	1/2	12.7	1.50	38.1	45.3	51.0	5000	0.78
D-1212-C619	12	3/4	19.0	1.50	38.1	59.7	58.0	5000	0.95
D-1216-C619	12	3/4	19.0	1.75	44.5	66.2	64.5	5000	0.95
D-1616-C619	16	1	25.4	1.75	44.5	70.6	67.0	5000	1.31
D-1620-C619	16	1	25.4	2.00	50.8	73.6	71.0	4000	1.45
D-2020-C619	20	1 1/4	31.8	2.00	50.8	88.0	84.0	4000	1.80
D-2024-C619	20	1 1/4	31.8	2.38	60.3	91.5	87.5	3000	1.98
D-2424-C619	24	1 1/2	38.1	2.38	60.3	104.8	91.0	3000	2.73
D-2432-C619	24	1 1/2	38.1	2.81	71.4	104.8	115.0	3000	3.04
D-3232-C619	32	2	50.8	2.81	71.4	129.3	130.0	3000	5.23

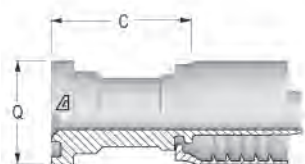

For Code 62 Split Flange Clamps, please refer to page 198.

Flange 6000 PSI SAE J518 Code 62

Part Number	Dash Size	Hose ID Size		Q Flange		C Cut-Off Factor (mm)	Max. Working Pressure (psi)	Weight (lbs/each)
		(in)	(mm)	(in)	(mm)			
D-1616-C62S	16	1	25.4	1	47.6	56.4	6000	1.27
D-2020-C62S	20	1 1/4	31.8	1 1/4	54.0	83.0	6000	2.01
D-2424-C62S	24	1 1/2	38.1	1 1/2	63.5	101.0	6000	2.77
D-2432-C62S	24	1 1/2	38.1	2	63.5	71.0	6000	3.35
D-3232-C62S	32	2	50.8	2	79.4	76.0	6000	4.76

Because we continually examine ways to improve our products, we reserve the right to alter specifications or discontinue products without prior notice.



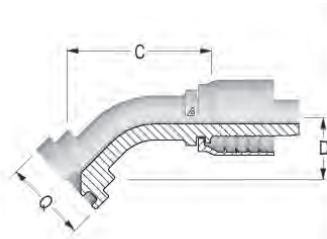

For Code 62 Split Flange Clamps, please refer to page 198.

45° Flange 6000 PSI SAE J518 Code 62

Part Number	Dash Size	Hose ID Size		Q Flange		C Cut-Off Factor (mm)	D Drop (mm)	Max. Working Pressure (psi)	Weight (lbs/each)
		(in)	(mm)	(in)	(mm)				
D-2020-C624	20	1 1/4	31.8	1 1/4	54.0	108.6	40	6000	2.25
D-2424-C624	24	1 1/2	38.1	1 1/2	63.5	122.9	45	6000	2.76
D-2432-C624	24	1 1/2	38.1	2	63.5	134.2	46	6000	3.34
D-3232-C624	32	2	50.8	2	79.4	156.6	60	6000	4.76

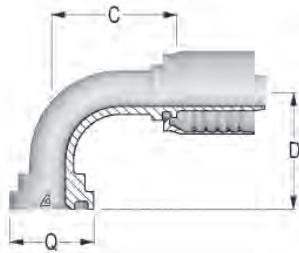

For Code 62 Split Flange Clamps, please refer to page 198.

90° Flange 6000 PSI SAE J518 Code 62

Part Number	Dash Size	Hose ID Size		Q Flange		C Cut-Off Factor (mm)	D Drop (mm)	Max WP (psi)	Weight (lbs/each)
		(in)	(mm)	(in)	(mm)				
D-1616-C629	16	1	25.4	1	47.6	73.6	75	6000	1.42
D-2020-C629	20	1 1/4	31.8	1 1/4	54.0	94.5	89	6000	2.36
D-2424-C629	24	1 1/2	38.1	1 1/2	63.5	99.6	105	6000	2.95
D-2432-C629	24	1 1/2	38.1	2	63.5	99.0	102	6000	3.28
D-3232-C629	32	2	50.8	2	79.4	143.3	132	6000	5.65

Because we continually examine ways to improve our products, we reserve the right to alter specifications or discontinue products without prior notice.

AlfaCrimp One-Piece Fittings - D Series



HOSES

ONE-PIECE B SERIES

ONE-PIECE D SERIES

ONE-PIECE F & P SERIES

TWO-PIECE FERRULES (A & PFR SERIES)

TWO-PIECE INSERTS (A SERIES)

TWO-PIECE INTERLOCK FERRULES & INSERTS (X & Z SERIES)

QUICK RELEASE

ASSEMBLY EQUIPMENT

TECHNICAL INFORMATION

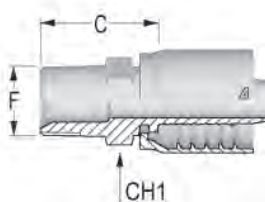

BSP/JIS Male Tapered

Part Number	Dash Size	Hose ID Size		F Thread		C Cut-Off Factor (mm)	CH1 (mm)	Weight (lbs/each)
		(in)	(mm)	Dash Size	Size (in) - TPI			
D-0606-MBPT	06	3/8	9.5	06	3/8-19	27.8	19	0.20
D-0608-MBPT	06	3/8	9.5	08	1/2-14	32.3	22	0.26
D-0808-MBPT	08	1/2	12.7	08	1/2-14	33.1	22	0.30
D-1012-MBPT	10	5/8	15.9	12	3/4-14	34.1	27	0.44
D-1212-MBPT	12	3/4	19.0	12	3/4-14	34.6	27	0.50
D-1216-MBPT	12	3/4	19.0	16	1-11	43.6	36	0.66
D-1616-MBPT	16	1	25.4	16	1-11	44.4	36	0.96
D-2020-MBPT	20	1 1/4	31.8	20	1 1/4-11	49.0	46	1.40
D-2424-MBPT	24	1 1/2	38.1	24	1 1/2-11	50.5	50	1.92
D-3232-MBPT	32	2	50.8	32	2-11	54.2	65	2.78

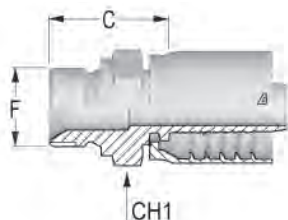

BSP Male Parallel 60° Seat

Part Number	Dash Size	Hose ID Size		F Thread		C Cut-Off Factor (mm)	CH1 (mm)	Weight (lbs/each)
		(in)	(mm)	Dash Size	Size (in) - TPI			
D-0606-MBPP	06	3/8	9.5	06	3/8-19	27.8	22	0.22
D-0608-MBPP	06	3/8	9.5	08	1/2-14	31.3	27	0.29
D-0806-MBPP	08	1/2	12.7	06	3/8-19	28.6	22	0.27
D-0808-MBPP	08	1/2	12.7	08	1/2-14	32.1	27	0.34
D-0810-MBPP	08	1/2	12.7	10	5/8-14	36.1	30	0.40
D-0812-MBPP	08	1/2	12.7	12	3/4-14	34.1	32	0.41
D-1010-MBPP	10	5/8	15.9	10	5/8-14	36.1	30	0.44
D-1012-MBPP	10	5/8	15.9	12	3/4-14	34.1	32	0.47
D-1212-MBPP	12	3/4	19.0	12	3/4-14	34.6	32	0.55
D-1216-MBPP	12	3/4	19.0	16	1-11	39.6	41	0.77
D-1616-MBPP	16	1	25.4	16	1-11	40.4	41	1.01
D-1620-MBPP	16	1	25.4	20	1 1/4-11	42.4	50	1.25
D-2020-MBPP	20	1 1/4	31.8	20	1 1/4-11	48.0	50	1.48
D-2424-MBPP	24	1 1/2	38.1	24	1 1/2-11	49.0	55	2.03
D-3232-MBPP	32	2	50.8	32	2-11	53.5	70	3.02

Because we continually examine ways to improve our products, we reserve the right to alter specifications or discontinue products without prior notice.



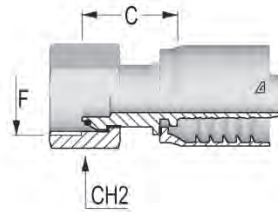

BSP O-Ring Female Swivel 60° Cone

Part Number	Dash Size	Hose ID Size		F Thread		C Cut-Off Factor (mm)	CH2 (mm)	Weight (lbs/each)
		(in)	(mm)	Dash Size	Size (in) - TPI			
D-0606-FBPO	06	3/8	9.5	06	3/8-19	17.0	22	0.21
D-0608-FBPO	06	3/8	9.5	08	1/2-14	17.0	27	0.26
D-0808-FBPO	08	1/2	12.7	08	1/2-14	18.0	27	0.30
D-0810-FBPO	08	1/2	12.7	10	5/8-14	28.4	27	0.35
D-0812-FBPO	08	1/2	12.7	12	3/4-14	22.0	32	0.36
D-1010-FBPO	10	5/8	15.9	10	5/8-14	17.1	27	0.34
D-1012-FBPO	10	5/8	15.9	12	3/4-14	20.0	32	0.43
D-1212-FBPO	12	3/4	19.0	12	3/4-14	20.6	32	0.50
D-1216-FBPO	12	3/4	19.0	16	1-11	34.0	38	0.65
D-1616-FBPO	16	1	25.4	16	1-11	23.9	38	0.87
D-1620-FBPO	16	1	25.4	20	1 1/4-11	39.4	50	1.33
D-2020-FBPO	20	1 1/4	31.8	20	1 1/4-11	32.0	50	1.48
D-2024-FBPO	20	1 1/4	31.8	24	1 1/2-11	41.9	55	1.82
D-2424-FBPO	24	1 1/2	38.1	24	1 1/2-11	33.8	55	3.05
D-3232-FBPO	32	2	50.8	32	2-11	34.0	70	3.13

HOSES

ONE-PIECE
B SERIESONE-PIECE
D SERIESONE-PIECE
F & P SERIESTWO-PIECE FERRULES
(A & PFR SERIES)TWO-PIECE INSERTS
(A SERIES)TWO-PIECE INTERLOCK
FERRULES & INSERTS
(X & Z SERIES)QUICK
RELEASEASSEMBLY
EQUIPMENTTECHNICAL
INFORMATION

Because we continually examine ways to improve our products, we reserve the right to alter specifications or discontinue products without prior notice.

AlfaCrimp One-Piece Fittings - D Series



HOSES

ONE-PIECE B SERIES

ONE-PIECE D SERIES

ONE-PIECE F & P SERIES

TWO-PIECE FERRULES (A & PFR SERIES)

TWO-PIECE INSERTS (A SERIES)

TWO-PIECE INTERLOCK FERRULES & INSERTS (X & Z SERIES)

QUICK RELEASE

ASSEMBLY EQUIPMENT

TECHNICAL INFORMATION

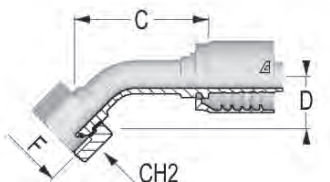

45° BSP O-Ring Female Swivel 60° Cone

Part Number	Dash Size	Hose ID Size		F Thread		C Cut-Off Factor (mm)	D Drop (mm)	CH2 (mm)	Weight (lbs/each)
		(in)	(mm)	Dash Size	Size (in) - TPI				
D-0606-FB04	06	3/8	9.5	06	3/8-19	49.9	20.5	22	0.26
D-0608-FB04	06	3/8	9.5	08	1/2-14	45.7	21.0	27	0.26
D-0808-FB04	08	1/2	12.7	08	1/2-14	55.0	21.0	27	0.36
D-0810-FB04	08	1/2	12.7	10	5/8-14	57.2	23.0	27	0.38
D-0812-FB04	08	1/2	12.7	12	3/4-14	56.7	23.0	32	0.40
D-1010-FB04	10	5/8	15.9	10	5/8-14	64.0	21.5	27	0.42
D-1012-FB04	10	5/8	15.9	12	3/4-14	66.5	22.5	32	0.62
D-1212-FB04	12	3/4	19.0	12	3/4-14	67.6	28.0	32	0.68
D-1216-FB04	12	3/4	19.0	16	1-11	74.6	31.5	38	0.86
D-1616-FB04	16	1	25.4	16	1-11	72.5	34.0	38	1.22
D-1620-FB04	16	1	25.4	20	1 1/4-11	89.0	38.0	50	1.42
D-2020-FB04	20	1 1/4	31.8	20	1 1/4-11	100.8	40.0	50	1.82
D-2024-FB04	20	1 1/4	31.8	24	1 1/2-11	108.0	46	55	2.48
D-2424-FB04	24	1 1/2	38.1	24	1 1/2-11	115.7	46	55	3.50
D-3232-FB04	32	2	50.8	32	2-11	151.5	60	70	4.96

Because we continually examine ways to improve our products, we reserve the right to alter specifications or discontinue products without prior notice.



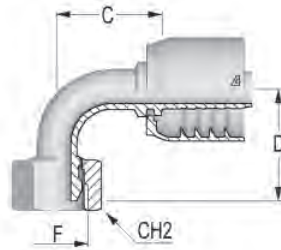

90° BSP O-Ring Female Swivel 60° Cone

Part Number	Dash Size	Hose ID Size		F Thread		C Cut-Off Factor (mm)	D Drop (mm)	CH2 (mm)	Weight (lbs/each)
		(in)	(mm)	Dash Size	Size (in) - TPI				
D-0606-FB09	06	3/8	9.5	06	3/8-19	34.8	42.0	22	0.26
D-0608-FB09	06	3/8	9.5	08	1/2-14	34.3	35.5	27	0.32
D-0808-FB09	08	1/2	12.7	08	1/2-14	35.8	41.0	27	0.38
D-0810-FB09	08	1/2	12.7	10	5/8-14	42.5	44.0	27	0.38
D-0812-FB09	08	1/2	12.7	12	3/4-14	42.5	43.0	32	0.47
D-1010-FB09	10	5/8	15.9	10	5/8-14	47.9	47.0	27	0.51
D-1012-FB09	10	5/8	15.9	12	3/4-14	51.9	49.0	32	0.60
D-1212-FB09	12	3/4	19.0	12	3/4-14	53.5	53.0	32	0.72
D-1216-FB09	12	3/4	19.0	16	1-11	54.0	61.0	38	0.90
D-1616-FB09	16	1	25.4	16	1-11	75.1	69.0	38	1.35
D-1620-FB09	16	1	25.4	20	1 1/4-11	75.1	88.5	50	1.98
D-2020-FB09	20	1 1/4	31.8	20	1 1/4-11	82.3	83.0	50	2.22
D-2024-FB09	20	1 1/4	31.8	24	1 1/2-11	91.0	94.0	55	2.70
D-2424-FB09	24	1 1/2	38.1	24	1 1/2-11	95.7	96.0	55	3.82
D-3232-FB09	32	2	50.8	32	2-11	128.5	136.0	70	5.42

Because we continually examine ways to improve our products, we reserve the right to alter specifications or discontinue products without prior notice.

AlfaCrimp One-Piece Fittings - D Series



HOSES
ONE-PIECE B SERIES
ONE-PIECE D SERIES
ONE-PIECE F & P SERIES
TWO-PIECE FERRULES (A & PFR SERIES)
TWO-PIECE INSERTS (A SERIES)
TWO-PIECE INTERLOCK FERRULES & INSERTS (X & Z SERIES)
QUICK RELEASE
ASSEMBLY EQUIPMENT
TECHNICAL INFORMATION

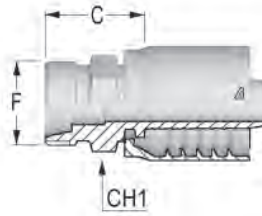

Metric Male 24° Seat DIN 3853 – Light

Part Number	Dash Size	Hose ID Size		F Thread		Tube OD (mm)	C Cut-Off Factor (mm)	CH1 (mm)	Weight (lbs/each)
		(in)	(mm)	Dash Size	Size (mm) x TP (mm)				
D-0616-MMSL	06	3/8	9.5	16	M16x1.5	10	23.3	17	0.18
D-0618-MMSL	06	3/8	9.5	18	M18x1.5	12	24.3	19	0.19
D-0622-MMSL	06	3/8	9.5	22	M22x1.5	15	25.3	22	0.22
D-0822-MMSL	08	1/2	12.7	22	M22x1.5	15	26.1	22	0.26
D-0826-MMSL	08	1/2	12.7	26	M26x1.5	18	27.1	27	0.33
D-1026-MMSL	10	5/8	15.9	26	M26x1.5	18	27.1	27	0.37
D-1230-MMSL	12	3/4	19.0	30	M30x2	22	31.6	32	0.50
D-1636-MMSL	16	1	25.4	36	M36x2	28	34.4	36	0.85
D-2045-MMSL	20	1 1/4	31.8	45	M45x2	35	40.0	46	1.29
D-2452-MMSL	24	1 1/2	38.1	52	M52x2	38	42.0	55	3.05

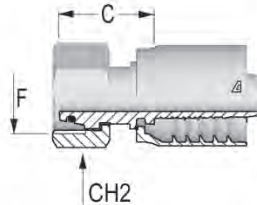

Metric Swivel Female O-Ring 24° Seat DIN 3865 – Light

Part Number	Dash Size	Hose ID Size		F Thread		Tube OD (mm)	C Cut-Off Factor (mm)	CH2 (mm)	Weight (lbs/each)
		(in)	(mm)	Dash Size	Size (mm) x TP (mm)				
D-0618-FMOL	06	3/8	9.5	18	M18x1.5	12	24.3	19	0.23
D-0822-FMOL	08	1/2	12.7	22	M22x1.5	15	26.1	22	0.32
D-1026-FMOL	10	5/8	15.9	26	M26x1.5	18	27.1	27	0.45
D-1230-FMOL	12	3/4	19.0	30	M30x2	22	31.6	32	0.62
D-1636-FMOL	16	1	25.4	36	M36x2	28	34.4	36	0.96
D-2045-FMOL	20	1 1/4	31.8	45	M45x2	35	40.0	46	1.38
D-2452-FMOL	24	1 1/2	38.1	52	M52x2	38	42.0	55	2.12

Because we continually examine ways to improve our products, we reserve the right to alter specifications or discontinue products without prior notice.



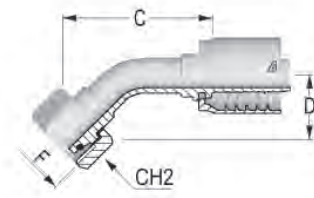

45° Metric O-Ring Female Swivel 24° Seat DIN 3865 – Light

Part Number	Dash Size	Hose ID Size		F Thread		Tube OD (mm)	C Cut-Off Factor (mm)	D Drop (mm)	CH2 (mm)	Weight (lbs/each)
		(in)	(mm)	Dash Size	Size (mm) x TP (mm)					
D-0618-FM4L	06	3/8	9.5	18	M18x1.5	12	46.8	19.5	22	0.26
D-0822-FM4L	08	1/2	12.7	22	M22x1.5	15	55.0	21.0	27	0.38
D-1026-FM4L	10	5/8	15.9	26	M26x1.5	18	65.3	24.0	32	0.54
D-1230-FM4L	12	3/4	19.0	30	M30x2	22	69.4	32.0	36	0.78
D-1636-FM4L	16	1	25.4	36	M36x2	28	91.4	32.0	41	1.17
D-2045-FM4L	20	1 1/4	31.4	45	M45x2	35	141.5	45.0	50	1.82
D-2452-FM4L	24	1 1/2	38.1	52	M52x2	42	112.0	38.0	60	2.77

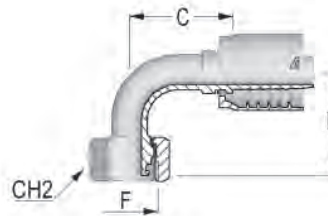

90° Metric O-Ring Female Swivel 24° Seat DIN 3865 – Light

Part Number	Dash Size	Hose ID Size		F Thread		Tube OD (mm)	C Cut-Off Factor (mm)	D Drop (mm)	CH2 (mm)	Weight (lbs/each)
		(in)	(mm)	Dash Size	Size (mm) x TP (mm)					
D-0618-FM9L	06	3/8	9.5	18	M18x1.5	12	32.8	39.0	22	0.27
D-0822-FM9L	08	1/2	12.7	22	M22x1.5	15	39.8	40.5	27	0.38
D-1026-FM9L	10	5/8	15.9	26	M26x1.5	18	51.4	48.0	32	0.56
D-1230-FM9L	12	3/4	19.0	30	M30x2	22	52.1	59.0	36	0.81
D-1636-FM9L	16	1	25.4	36	M36x2	28	77.6	68.0	41	1.29
D-2045-FM9L	20	1 1/4	31.8	45	M45x2	35	90.5	89.0	50	2.04
D-2452-FM9L	24	1 1/2	38.1	52	M52x2	38	106.5	100.0	60	3.18

Because we continually examine ways to improve our products, we reserve the right to alter specifications or discontinue products without prior notice.

AlfaCrimp One-Piece Fittings - D Series



HOSES

ONE-PIECE B SERIES

ONE-PIECE D SERIES

ONE-PIECE F & P SERIES

TWO-PIECE FERRULES (A & PFR SERIES)

TWO-PIECE INSERTS (A SERIES)

TWO-PIECE INTERLOCK FERRULES & INSERTS (X & Z SERIES)

QUICK RELEASE

ASSEMBLY EQUIPMENT

TECHNICAL INFORMATION

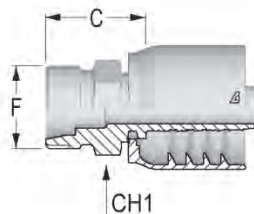

Metric Male 24° Seat DIN 3861 – Heavy

Part Number	Dash Size	Hose ID Size		F Thread		Tube OD (mm)	C Cut-Off Factor (mm)	CH1 (mm)	Weight (lbs/each)
		(in)	(mm)	Dash Size	Size (mm) x TP (mm)				
D-0620-MMSH	06	3/8	9.5	20	M20x1.5	12	25.3	22	0.22
D-0622-MMSH	06	3/8	9.5	22	M22x1.5	14	27.3	22	0.23
D-0824-MMSH	08	1/2	12.7	24	M24x1.5	16	29.1	24	0.29
D-1030-MMSH	10	5/8	15.9	30	M30x2	20	33.1	32	0.44
D-1236-MMSH	12	3/4	19.0	36	M36x2	28	37.6	36	0.65
D-1642-MMSH	16	1	25.4	42	M42x2	30	42.4	46	1.19
D-2052-MMSH	20	1 1/4	31.8	52	M52x2	38	48.0	55	1.65

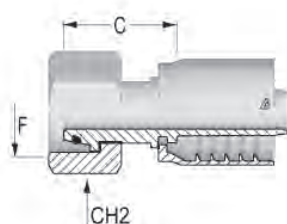

Metric Swivel Female O-Ring 24° Seat DIN 3865 – Heavy

Part Number	Dash Size	Hose ID Size		F Thread		Tube OD (mm)	C Cut-Off Factor (mm)	CH2 (mm)	Weight (lbs/each)
		(in)	(mm)	Dash Size	Size (mm) x TP (mm)				
D-0620-FMOH	06	3/8	9.5	20	M20x1.5	12	27.6	24	0.25
D-0622-FMOH	06	3/8	9.5	22	M22x1.5	14	31.1	27	0.31
D-0824-FMOH	08	1/2	12.7	24	M24x1.5	16	31.7	30	0.40
D-1030-FMOH	10	5/8	15.9	30	M30x2	22	36.5	36	0.59
D-1236-FMOH	12	3/4	19.0	36	M36x2	28	40.2	46	0.99
D-1642-FMOH	16	1	25.4	42	M42x2	30	43.1	50	1.40
D-2052-FMOH	20	1 1/4	31.8	52	M52x2	38	48.1	60	2.04

Because we continually examine ways to improve our products, we reserve the right to alter specifications or discontinue products without prior notice.



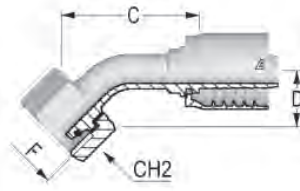

45° Metric O-Ring Female Swivel 24° Seat DIN 3865 – Heavy

Part Number	Dash Size	Hose ID Size		F Thread		Tube OD (mm)	C Cut-Off Factor (mm)	D Drop (mm)	CH2 (mm)	Weight (lbs/each)
		(in)	(mm)	Dash Size	Size (mm) x TP (mm)					
D-0620-FM4H	06	3/8	9.5	20	M20x1.5	12	50.6	20.0	24	0.28
D-0622-FM4H	06	3/8	9.5	22	M22x1.5	14	52.9	21.0	27	0.34
D-0824-FM4H	08	1/2	12.7	24	M24x1.5	16	55.8	21.5	30	0.42
D-1030-FM4H	10	5/8	15.9	30	M30x2	22	66.3	30.0	36	0.68
D-1236-FM4H	12	3/4	19.0	36	M36x2	28	69.5	33.0	46	1.11
D-1642-FM4H	16	1	25.4	42	M42x2	30	110.3	40.5	50	1.74
D-2052-FM4H	20	1 1/4	31.8	52	M52x2	38	109.0	45.0	60	2.40

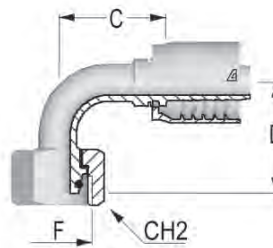

90° Metric O-Ring Female Swivel 24° Seat DIN 3865 – Heavy

Part Number	Dash Size	Hose ID Size		F Thread		Tube OD (mm)	C Cut-Off Factor (mm)	D Drop (mm)	CH2 (mm)	Weight (lbs/each)
		(in)	(mm)	Dash Size	Size (mm) x TP (mm)					
D-0620-FM9H	06	3/8	9.5	20	M20x1.5	12	34.3	38.5	24	0.29
D-0622-FM9H	06	3/8	9.5	22	M22x1.5	14	34.3	40.5	27	0.35
D-0824-FM9H	08	1/2	12.7	24	M24x1.5	16	39.8	41.5	30	0.45
D-1030-FM9H	10	5/8	15.9	30	M30x2	22	47.9	55.0	36	0.69
D-1236-FM9H	12	3/4	19.0	36	M36x2	28	50.6	59.5	46	1.12
D-1642-FM9H	16	1	25.4	42	M42x2	30	75.6	79.0	50	1.81
D-2052-FM9H	20	1 1/4	31.8	52	M52x2	38	94.0	92.0	60	2.59

Because we continually examine ways to improve our products, we reserve the right to alter specifications or discontinue products without prior notice.

One-Piece AlfaCrimp F & P Series Fittings Index

HOSES
ONE-PIECE B SERIES
ONE-PIECE D SERIES
ONE-PIECE F & P SERIES
TWO-PIECE FERRULES (A & PFR SERIES)
TWO-PIECE INSERTS (A SERIES)
TWO-PIECE INTERLOCK FERRULES & INSERTS (X & Z SERIES)
QUICK RELEASE
ASSEMBLY EQUIPMENT
TECHNICAL INFORMATION

API

 API Male NPT.....149

NPTF

 NPTF Male 60° Seat 151(F), 152(P)

 NPTF Male 60° Seat139

 NPTF Swivel Male 60° Seat..... 151

JIC

 JIC Female Swivel 37° Seat with Stem Hexagon 139

 JIC Female 37° Seat..... 152(P)

 JIC Male.....139

 45° JIC Female Swivel 37° Seat.....140

 90° JIC Female Swivel 37° Seat.....140

ORFS

 ORFS Female with Stem Hexagon 141

 45° ORFS Female 141

 90° ORFS Female 141

SAE

 SAE Male O-Ring Boss..... 152(P)

SAE Flange Code 61

 Code 61 Flange 45 Degree 142

 Code 61 Flange 90 Degree143

 Flange SAE J518 Code 61.....142

SAE Flange Code 62

 Flange SAE 6000 PSI J518 Code 62143

 45° Flange 6000 PSI SAE J518 Code 62144

 90° Flange 6000 PSI SAE J518 Code 62.....144

Caterpillar Flange

 SUPERCAT Flange145

 22.5° SUPERCAT Flange.....145

 30° SUPERCAT Flange.....146

 45° SUPERCAT Flange146

 60° SUPERCAT Flange 147

 67.5° SUPERCAT Flange 147

 90° SUPERCAT Flange.....148

Metric

 Metric Male 24° Seat DIN 3865 Heavy.....148

 Metric Swivel Female O-Ring 24° Seat DIN 3865 - Heavy148

 90° Metric Swivel O-Ring Female 24° Seat DIN 3865 - Heavy149

Hammer Unions

 Male Hammer Union Fig. 1502 Integral fitting with Lug Nut....150

 Female Hammer Union Fig. 1502 integral fitting with Rubber Ring150

Because we continually examine ways to improve our products, we reserve the right to alter specifications or discontinue products without prior notice.

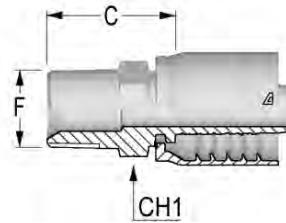

NPTF Male 60° Seat

Part Number	Dash Size	Hose ID Size		F Thread		C Cut-Off Factor (mm)	CH1 (mm)	Weight (lbs/each)
		(in)	(mm)	Dash Size	Size (in) - TPI			
F-1212-MNPT	12	3/4	19.0	12	3/4-14	34.6	27	0.75
F-1616-MNPT	16	1	25.4	16	1-11 1/2	43.4	36	1.25
F-2020-MNPT	20	1 1/4	31.8	20	1 1/4-11	46.8	46	2.34
F-2424-MNPT	24	1 1/2	38.1	24	1 1/2-11 1/2	49.5	50	2.47
F-3232-MNPT	32	2	50.8	32	2-11 1/2	53.7	65	3.24

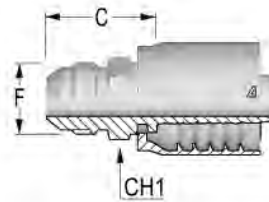

JIC Male

Part Number	Dash Size	Hose ID Size		F Thread		C Cut-Off Factor (mm)	CH1 (mm)	Weight (lbs/each)
		(in)	(mm)	Dash Size	Size (in) - TPI			
F-3232-MJIC	32	2	50.8	32	2 1/2-12	55.4	70	3.50

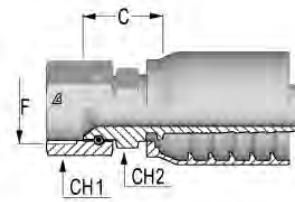

JIC Female Swivel 37° Seat with Stem Hexagon

Part Number	Dash Size	Hose ID Size		F Thread		C Cut-Off Factor (mm)	CH1 (mm)	CH2 (mm)	Weight (lbs/each)
		(in)	(mm)	Dash Size	Size (in) - TPI				
F-1212-FJDH	12	3/4	19.0	12	1 1/16-12	30.2	27	32	0.84
F-1616-FJDH	16	1	25.4	16	1 5/16-12	38.0	36	38	1.34
F-1620-FJDH	16	1	25.4	20	1 5/8-12	41.6	36	50	1.90
F-2020-FJDH	20	1 1/4	31.8	20	1 5/8-12	43.1	41	50	2.38
F-2424-FJDH	24	1 1/2	38.1	24	1 7/8-12	49.4	50	55	3.13
F-3232-FJDH	32	2	50.8	32	2 1/2-12	67.0	65	70	3.79

Because we continually examine ways to improve our products, we reserve the right to alter specifications or discontinue products without prior notice.

AlfaCrimp One-Piece Fittings - F Series



HOSES

ONE-PIECE B SERIES

ONE-PIECE D SERIES

ONE-PIECE F & P SERIES

TWO-PIECE FERRULES (A & PFR SERIES)

TWO-PIECE INSERTS (A SERIES)

TWO-PIECE INTERLOCK FERRULES & INSERTS (X & Z SERIES)

QUICK RELEASE

ASSEMBLY EQUIPMENT

TECHNICAL INFORMATION

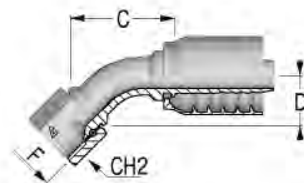

45° JIC Female Swivel 37° Seat

Part Number	Dash Size	Hose ID Size		F Thread		C Cut-Off Factor (mm)	D Drop (mm)	CH (mm)	Weight (lbs/each)
		(in)	(mm)	Dash Size	Size (in) - TPI				
F-1212-FJ45	12	3/4	19.0	12	1 1/16-12	67.4	27.5	32	0.99
F-1616-FJ45	16	1	25.4	16	1 5/16-12	77.9	31.0	38	1.54
F-2020-FJ45	20	1 1/4	31.8	20	1 5/8-12	99.0	37.0	50	2.71
F-2424-FJ45	24	1 1/2	38.1	24	1 7/8-12	118.0	43.5	55	3.43
F-3232-FJ45	32	2	50.8	32	2 1/2-12	162.3	51.5	70	4.83

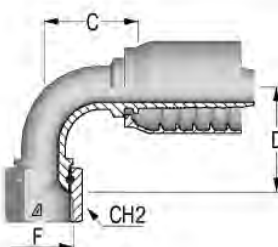

90° JIC Female Swivel 37° Seat

Part Number	Dash Size	Hose ID Size		F Thread		C Cut-Off Factor (mm)	D Drop (mm)	CH2 (mm)	Weight (lbs/each)
		(in)	(mm)	Dash Size	Size (in) - TPI				
F-1212-FJ9M	12	3/4	19.0	12	1 1/16-12	59.0	57.0	32	1.01
F-1616-FJ9M	16	1	25.4	16	1 5/16-12	76.0	67.0	38	1.63
F-2020-FJ9M	20	1 1/4	31.8	20	1 5/8-12	67.5	71.1	50	2.82
F-2424-FJ9M	24	1 1/2	38.1	24	1 7/8-12	105.0	92.0	55	3.53
F-3232-FJ9M	32	2	50.8	32	2 1/2-12	147.5	135.0	70	4.91

Because we continually examine ways to improve our products, we reserve the right to alter specifications or discontinue products without prior notice.



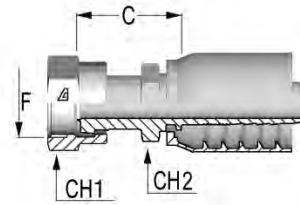

ORFS Female with Stem Hexagon

Part Number	Dash Size	Hose ID Size		F Thread		C Cut-Off Factor (mm)	CH1 (mm)	CH2 (mm)	Weight (lbs/each)
		(in)	(mm)	Dash Size	Size (in) - TPI				
F-1212-FOFS	12	3/4	19.0	12	1 3/16-12	44.5	30	36	0.79
F-1216-FOFS	12	3/4	19.0	16	1 7/16-12	50.5	36	41	0.99
F-1616-FOFS	16	1	25.4	16	1 7/16-12	52.5	36	41	1.17
F-1620-FOFS	16	1	25.4	20	1 11/16-12	53.5	41	50	2.09
F-2020-FOFS	20	1 1/4	31.8	20	1 11/16-12	56.0	41	50	2.47
F-2424-FOFS	24	1 1/2	38.1	24	2-12	67.5	50	60	3.02

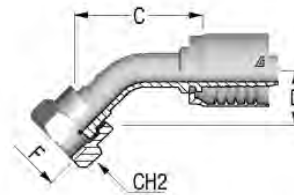

45° ORFS Female

Part Number	Dash Size	Hose ID Size		F Thread		C Cut-Off Factor (mm)	D Drop (mm)	CH2 (mm)	Weight (lbs/each)
		(in)	(mm)	Dash Size	Size (in) - TPI				
F-1212-F045	12	3/4	19.0	12	1 3/16-12	81	26	36	1.17
F-1216-F045	12	3/4	19.0	16	1 7/16-12	81	28	41	1.43
F-1616-F045	16	1	25.4	16	1 7/16-12	94	28	41	1.65
F-2020-F045	20	1 1/4	31.8	20	1 11/16-12	115	36.5	50	2.94

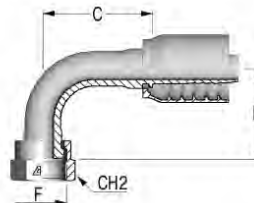

90° ORFS Female

Part Number	Dash Size	Hose ID Size		F Thread		C Cut-Off Factor (mm)	D Drop (mm)	CH2 (mm)	Weight (lbs/each)
		(in)	(mm)	Dash Size	Size (in) - TPI				
F-1212-F09M	12	3/4	19.0	12	1 3/16-12	68	58	36	1.26
F-1216-F09M	12	3/4	19.0	16	1 7/16-12	70	58	41	1.57
F-1616-F09M	16	1	25.4	16	1 7/16-12	80	66	41	1.76
F-2020-F09M	20	1 1/4	31.8	20	1 11/16-12	102	81	50	2.67

Because we continually examine ways to improve our products, we reserve the right to alter specifications or discontinue products without prior notice.

AlfaCrimp One-Piece Fittings - F Series



NEW

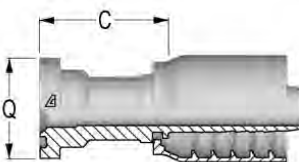

Flange SAE J518 Code 61

Part Number	Dash Size	Hose ID Size		Q Flange		C Cut-Off Factor (mm)	Flange Dash Size	Weight (lbs/each)
		(in)	(mm)	(in)	(mm)			
F-1212-C61S	12	3/4	19.0	1.50	38.1	43.5	12	0.95
F-1616-C61S	16	1	25.4	1.75	44.5	53.5	16	1.45
F-1620-C61S	16	1	25.4	2.00	50.8	56.0	20	1.70
F-2020-C61S	20	1 1/4	31.8	2.00	50.8	58.5	20	2.30
F-2024-C61S	20	1 1/4	31.8	2.38	60.3	61.5	24	2.75
F-2420-C61S	24	1 1/2	38.1	2.00	50.8	55.5	20	3.10
F-2424-C61S	24	1 1/2	38.1	2.38	60.3	63.5	24	3.25
F-2432-C61S	24	1 1/2	38.1	2.81	71.4	75.0	32	5.05
F-3232-C61S	32	2	50.8	2.81	71.4	85.0	32	5.75

NEW

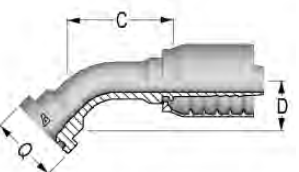

Code 61 Flange 45 Degree

Part Number	Dash Size	Hose ID Size		Q Flange		C Cut-Off Factor (mm)	D Drop (mm)	Flange Dash Size	Weight (lbs/each)
		(in)	(mm)	(in)	(mm)				
F-1212-C614	12	3/4	19.0	1.50	38.1	71.0	28.0	12	1.10
F-1616-C614	16	1	25.4	1.75	44.5	88.0	35.0	16	1.85
F-1620-C614	16	1	25.4	2.00	50.8	88.9	32.5	20	2.05
F-2020-C614	20	1 1/4	31.8	2.00	50.8	94.3	38.5	20	2.70
F-2024-C614	20	1 1/4	31.8	2.38	60.3	99.0	40.0	24	3.20
F-2424-C614	24	1 1/2	38.1	2.38	60.3	99.8	43.0	24	3.95
F-2432-C614	24	1 1/2	38.1	2.81	71.4	140.0	56.5	32	4.50
F-3232-C614	32	2	50.8	2.81	71.4	154.0	54.0	32	4.80

Because we continually examine ways to improve our products, we reserve the right to alter specifications or discontinue products without prior notice.



HOSES

ONE-PIECE B SERIES

ONE-PIECE D SERIES

ONE-PIECE F & P SERIES

TWO-PIECE FERRULES (A & PFR SERIES)

TWO-PIECE INSERTS (A SERIES)

TWO-PIECE INTERLOCK FERRULES & INSERTS (X & Z SERIES)

QUICK RELEASE

ASSEMBLY EQUIPMENT

TECHNICAL INFORMATION

NEW

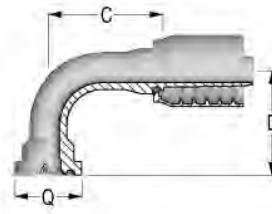

Code 61 Flange 90 Degree

Part Number	Dash Size	Hose ID Size		Q Flange		C Cut-Off Factor (mm)	D Drop (mm)	Flange Dash Size	Weight (lbs/each)
		(in)	(mm)	(in)	(mm)				
F-1212-C619	12	3/4	19.0	1.50	38.1	65.0	58.0	12	1.25
F-1616-C619	16	1	25.4	1.75	44.5	78.1	64.0	16	1.80
F-1620-C619	16	1	25.4	2.00	50.8	74.7	69.0	20	2.35
F-2020-C619	20	1 1/4	31.8	2.00	50.8	92.0	81.0	20	3.00
F-2024-C619	20	1 1/4	31.8	2.38	60.3	97.0	85.0	24	3.60
F-2424-C619	24	1 1/2	38.1	2.38	60.3	103.0	93.0	24	4.25
F-2432-C619	24	1 1/2	38.1	2.81	71.4	138.0	97.0	32	4.75
F-3232-C619	32	2	50.8	2.81	71.4	139.0	130.0	32	4.95

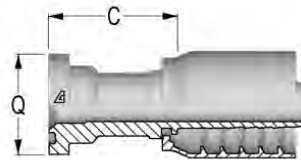

For Code 62 Split Flange Clamps, please refer to page 198.

Flange SAE 6000 PSI J518 Code 62

Part Number	Dash Size	Hose ID Size		Q Flange		C Cut-Off Factor (mm)	Flange Dash Size	Weight (lbs/each)
		(in)	(mm)	(in)	(mm)			
F-1212-C62S	12	3/4	19.0	1.63	41.3	53.5	12	0.97
F-1216-C62S	12	3/4	19.0	1.88	47.6	56.5	16	1.12
F-1612-C62S	16	1	25.4	1.63	41.3	63.5	12	1.42
F-1616-C62S	16	1	25.4	1.88	47.6	58.5	16	1.48
F-1620-C62S	16	1	25.4	2.13	54.0	65.5	20	1.72
F-1624-C62S	16	1	25.4	2.50	63.5	65.5	24	1.91
F-2016-C62S	20	1 1/4	31.8	1.88	47.6	55.2	16	2.16
F-2020-C62S	20	1 1/4	31.8	2.13	54.0	64.0	20	2.34
F-2024-C62S	20	1 1/4	31.8	2.50	63.5	74.0	24	2.78
F-2420-C62S	24	1 1/2	38.1	2.13	54.0	76.0	20	3.09
F-2424-C62S	24	1 1/2	38.1	2.50	63.5	76.0	24	3.31
F-2432-C62S	24	1 1/2	38.1	3.13	79.4	88.0	32	5.18
F-3232-C62S	32	2	50.8	3.13	79.4	103.0	32	5.84

Because we continually examine ways to improve our products, we reserve the right to alter specifications or discontinue products without prior notice.

AlfaCrimp One-Piece Fittings - F Series



HOSES
ONE-PIECE B SERIES
ONE-PIECE D SERIES
ONE-PIECE F & P SERIES
TWO-PIECE FERRULES (A & PFR SERIES)
TWO-PIECE INSERTS (A SERIES)
TWO-PIECE INTERLOCK FERRULES & INSERTS (X & Z SERIES)
QUICK RELEASE
ASSEMBLY EQUIPMENT
TECHNICAL INFORMATION

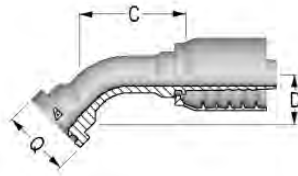

For Code 62 Split Flange Clamps, please refer to page 198.

45° Flange 6000 PSI SAE J518 Code 62

Part Number	Dash Size	Hose ID Size		Q Flange		C Cut-Off Factor (mm)	D Drop (mm)	Flange Dash Size	Weight (lbs/each)
		(in)	(mm)	(in)	(mm)				
F-1212-C624	12	3/4	19.0	1.63	41.3	75.0	30.0	12	1.12
F-1216-C624	12	3/4	19.0	1.88	47.6	80.0	33.0	16	1.32
F-1612-C624	16	1	25.4	1.63	41.3	85.0	29.5	12	1.59
F-1616-C624	16	1	25.4	1.88	47.6	98.0	38.5	16	1.87
F-1620-C624	16	1	25.4	2.13	54.0	96.0	44.0	20	2.09
F-2020-C624	20	1 1/4	31.8	2.13	54.0	103.0	41.0	20	2.73
F-2024-C624	20	1 1/4	31.8	2.50	63.5	117.0	48.0	24	3.24
F-2424-C624	24	1 1/2	38.1	2.50	63.5	144.0	48.0	24	4.00
F-2432-C624	24	1 1/2	38.1	3.13	79.4	137.0	55.0	32	4.61
F-3232-C624	32	2	50.8	3.13	79.4	177.0	61.0	32	4.83

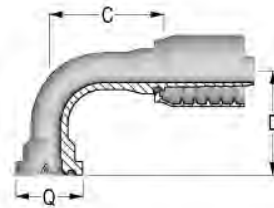

For Code 62 Split Flange Clamps, please refer to page 198.

90° Flange 6000 PSI SAE J518 Code 62

Part Number	Dash Size	Hose ID Size		Q Flange		C Cut-Off Factor (mm)	D Drop (mm)	Flange Dash Size	Weight (lbs/each)
		(in)	(mm)	(in)	(mm)				
F-1212-C629	12	3/4	19.0	1.63	41.3	65.0	64.0	12	1.28
F-1216-C629	12	3/4	19.0	1.88	47.6	65.0	66.0	16	1.43
F-1612-C629	16	1	25.4	1.63	41.3	75.0	61.0	12	1.55
F-1616-C629	16	1	25.4	1.88	47.6	75.0	74.0	16	1.87
F-1620-C629	16	1	25.4	2.13	54.0	79.0	85.0	20	2.36
F-1624-C629	16	1	25.4	2.50	63.5	79.0	85.0	24	2.82
F-2020-C629	20	1 1/4	31.8	2.13	54.0	96.0	91.0	20	3.02
F-2024-C629	20	1 1/4	31.8	2.50	63.5	99.0	103.5	24	3.64
F-2420-C629	24	1 1/2	38.1	2.13	54.0	112.0	85.0	20	3.91
F-2424-C629	24	1 1/2	38.1	2.50	63.5	114.0	109.0	24	4.30
F-2432-C629	24	1 1/2	38.1	3.13	79.4	118.0	121.5	32	4.78
F-3232-C629	32	2	50.8	3.13	79.4	172.0	131.0	32	4.98

Because we continually examine ways to improve our products, we reserve the right to alter specifications or discontinue products without prior notice.



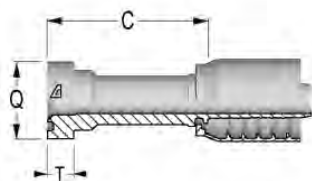

SUPERCAT Flange

Part Number	Dash Size	Hose ID Size		Q Flange		C Cut-Off Factor (mm)	T Thickness (mm)	Flange Dash Size	Weight (lbs/each)
		(in)	(mm)	(in)	(mm)				
F-1212-CFLS	12	3/4	19.0	1.63	41.3	85.5	14.3	12	1.26
F-1216-CFLS	12	3/4	19.0	1.88	47.6	85.5	14.3	16	1.41
F-1616-CFLS	16	1	25.4	1.88	47.6	94.5	14.3	16	1.87
F-1620-CFLS	16	1	25.4	2.13	54.0	94.5	14.3	20	2.05
F-2020-CFLS	20	1 1/4	31.8	2.13	54.0	92.0	14.3	20	2.26
F-2024-CFLS	20	1 1/4	31.8	2.50	63.5	87.0	14.3	20	2.26
F-2424-CFLS	24	1 1/2	38.1	2.50	63.5	89.0	14.3	24	2.40
F-3232-CFLS	32	2	50.8	3.12	79.4	105.0	14.3	32	3.50

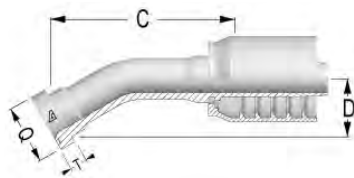

22.5° SUPERCAT Flange

Part Number	Dash Size	Hose ID Size		Q Flange		C Cut-Off Factor (mm)	T Thickness (mm)	D Drop (mm)	Flange Dash Size	Weight (lbs/each)
		(in)	(mm)	(in)	(mm)					
F-1212-CFL2	12	3/4	19.0	1.63	41.3	116.0	14.2	21.0	12	1.34
F-1216-CFL2	12	3/4	19.0	1.88	47.6	121.0	14.2	17.0	16	1.52
F-1616-CFL2	16	1	25.4	1.88	47.6	106.0	14.2	17.0	16	1.72
F-1620-CFL2	15	1	25.4	2.13	54.0	129.0	14.2	18.0	20	2.02
F-2020-CFL2	20	1 1/4	31.8	2.13	54.0	162.0	14.2	25.5	20	2.58
F-2024-CFL2	20	1 1/4	31.8	2.50	63.5	170.0	14.2	22.0	24	2.65

Because we continually examine ways to improve our products, we reserve the right to alter specifications or discontinue products without prior notice.

AlfaCrimp One-Piece Fittings - F Series



HOSES

ONE-PIECE B SERIES

ONE-PIECE D SERIES

ONE-PIECE F & P SERIES

TWO-PIECE FERRULES (A & PFR SERIES)

TWO-PIECE INSERTS (A SERIES)

TWO-PIECE INTERLOCK FERRULES & INSERTS (X & Z SERIES)

QUICK RELEASE

ASSEMBLY EQUIPMENT

TECHNICAL INFORMATION

NEW

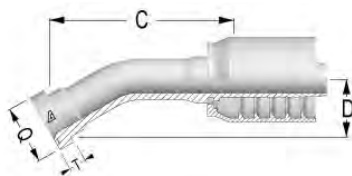

30° SUPERCAT Flange

Part Number	Dash Size	Hose ID Size		Q Flange		C Cut-Off Factor (mm)	T Thickness (mm)	D Drop (mm)	Flange Dash Size	Weight (lbs/each)
		(in)	(mm)	(in)	(mm)					
F-1212-CFL3	12	3/4	19.0	1.63	41.3	115.0	14.2	24.0	12	1.34
F-1216-CFL3	12	3/4	19.0	1.88	47.6	118.0	14.2	26.5	16	1.52
F-1616-CFL3	16	1	25.4	1.88	47.6	139.0	14.2	27.0	16	1.72
F-1620-CFL3	15	1	25.4	2.13	54.0	137.0	14.2	25.5	20	2.02
F-2020-CFL3	20	1 1/4	31.8	2.13	54.0	160.0	14.2	28.0	20	2.58
F-2024-CFL3	20	1 1/4	31.8	2.50	63.5	167.0	14.2	37.5	24	2.65

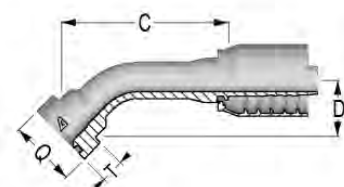

45° SUPERCAT Flange

Part Number	Dash Size	Hose ID Size		Q Flange		C Cut-Off Factor (mm)	T Thickness (mm)	D Drop (mm)	Flange Dash Size	Weight (lbs/each)
		(in)	(mm)	(in)	(mm)					
F-1212-CFL4	12	3/4	19.0	1.63	41.3	103.0	14.3	34.0	12	1.34
F-1216-CFL4	12	3/4	19.0	1.88	47.6	106.5	14.3	36.0	16	1.52
F-1616-CFL4	16	1	25.4	1.88	47.6	129.0	14.3	42.5	16	1.72
F-1620-CFL4	16	1	25.4	2.13	54.0	128.0	14.3	40.0	20	2.02
F-2020-CFL4	20	1 1/4	31.8	2.13	54.0	150.0	14.3	45.0	20	2.58
F-2024-CFL4	20	1 1/4	31.8	2.50	63.5	152.0	14.3	60.0	24	2.65
F-2424-CFL4	24	1 1/2	38.1	2.50	63.5	181.0	14.3	52.0	24	2.95
F-3232-CFL4	32	2	50.8	3.12	79.4	168.0	14.3	63.0	32	3.95

Because we continually examine ways to improve our products, we reserve the right to alter specifications or discontinue products without prior notice.



NEW

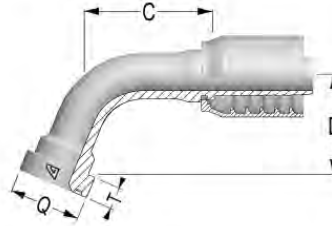

60° SUPERCAT Flange

Part Number	Dash Size	Hose ID Size		Q Flange		C Cut-Off Factor (mm)	T Thickness (mm)	D Drop (mm)	Flange Dash Size	Weight (lbs/each)
		(in)	(mm)	(in)	(mm)					
F-1212-CFL6	12	3/4	19.0	1.63	41.3	92.6	14.2	46.0	12	1.12
F-1216-CFL6	12	3/4	19.0	1.88	47.6	95.6	14.2	48.5	16	1.38
F-1616-CFL6	16	1	25.4	1.88	47.6	118.0	14.2	59.0	16	2.13
F-1620-CFL6	16	1	25.4	2.13	54.0	118.0	14.2	57.0	20	2.21
F-2020-CFL6	20	1 1/4	31.8	2.13	54.0	135.0	14.2	65.0	20	3.57
F-2024-CFL6	20	1 1/4	31.8	2.50	63.5	141.0	14.2	67.5	24	3.65

NEW

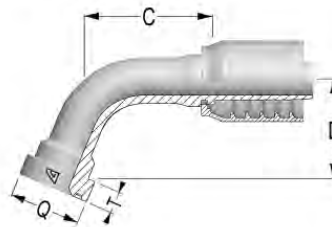

67.5° SUPERCAT Flange

Part Number	Dash Size	Hose ID Size		Q Flange		C Cut-Off Factor (mm)	T Thickness (mm)	D Drop (mm)	Flange Dash Size	Weight (lbs/each)
		(in)	(mm)	(in)	(mm)					
F-1212-CFL7	12	3/4	19.0	1.63	41.3	86.1	14.2	51.8	12	1.12
F-1216-CFL7	12	3/4	19.0	1.88	47.6	88.8	14.2	54.6	16	1.38
F-1616-CFL7	16	1	25.4	1.88	47.6	111.0	14.2	67.0	16	2.13
F-1620-CFL7	16	1	25.4	2.13	54.0	109.0	14.2	64.0	20	2.21
F-2020-CFL7	20	1 1/4	31.8	2.13	54.0	119.3	14.2	70.6	20	3.57
F-2024-CFL7	20	1 1/4	31.8	2.50	63.5	132.0	14.2	77.0	24	3.65

Because we continually examine ways to improve our products, we reserve the right to alter specifications or discontinue products without prior notice.

AlfaCrimp One-Piece Fittings - F Series



HOSES
ONE-PIECE B SERIES
ONE-PIECE D SERIES
ONE-PIECE F & P SERIES
TWO-PIECE FERRULES (A & PFR SERIES)
TWO-PIECE INSERTS (A SERIES)
TWO-PIECE INTERLOCK FERRULES & INSERTS (X & Z SERIES)
QUICK RELEASE
ASSEMBLY EQUIPMENT
TECHNICAL INFORMATION

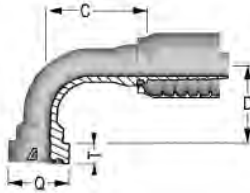

90° SUPERCAT Flange

Part Number	Dash Size	Hose ID Size		Q Flange		C Cut-Off Factor (mm)	T Thickness (mm)	D Drop (mm)	Flange Dash Size	Weight (lbs/each)
		(in)	(mm)	(in)	(mm)					
F-1212-CFL9	12	3/4	19.0	1.63	41.3	67.0	14.3	67.0	12	1.12
F-1216-CFL9	12	3/4	19.0	1.88	47.6	69.0	14.3	70.0	16	1.38
F-1616-CFL9	16	1	25.4	1.88	47.6	85.0	14.3	79.0	16	2.13
F-1620-CFL9	16	1	25.4	2.13	54.0	80.0	14.3	82.5	20	2.21
F-2020-CFL9	20	1 1/4	31.8	2.13	54.0	97.0	14.3	93.0	20	3.57
F-2024-CFL9	20	1 1/4	31.8	2.50	63.5	97.0	14.3	101.0	24	3.85
F-2424-CFL9	24	1 1/2	38.1	2.50	63.5	117.0	14.3	109.0	24	4.25
F-3232-CFL9	32	2	50.8	3.12	79.4	141.0	14.3	138.5	32	5.25

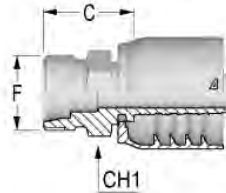

Metric Male 24° Seat DIN 3865 Heavy

Part Number	Dash Size	Hose ID Size		F Thread		C Cut-Off Factor (mm)	CH2 (mm)	Weight (lbs/each)
		(in)	(mm)	Dash Size	Size (mm) x TP(mm)			
F-1642-MMSH	16	1	25.4	42	M42x2.0	51.0	50.0	2.34

NEW

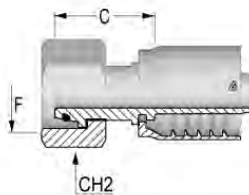

Metric Swivel Female O-Ring 24° Seat DIN 3865 - Heavy

Part Number	Dash Size	Hose ID Size		F Thread		C Cut-Off Factor (mm)	CH2 (mm)	Weight (lbs/each)
		(in)	(mm)	Dash Size	Size (mm) x TP(mm)			
F-1230-FMOH	12	3/4	19.0	30	M30x2.0	37.0	36.0	0.99
F-1636-FMOH	16	1	25.4	36	M36x2.0	40.8	46.0	1.17
F-1642-FMOH	16	1	25.4	42	M42x2.0	45.2	50.0	2.09

Because we continually examine ways to improve our products, we reserve the right to alter specifications or discontinue products without prior notice.



NEW

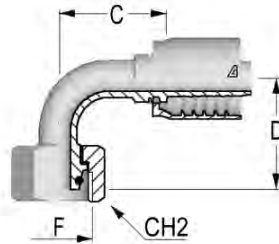

90° Metric O-Ring Female Swivel 24° Seat DIN 3865 – Heavy

Part Number	Dash Size	Hose ID Size		F Thread		C Cut-Off Factor (mm)	D Drop (mm)	CH2 (mm)	Weight (lbs/each)
		(in)	(mm)	Dash Size	Size (mm) x TP(mm)				
F-1636-FM9H	16	1	25.4	36	M36x2.0	75.6	82.0	46.0	1.76
F-1642-FM9H	16	1	25.4	42	M42x2.0	80.2	85.0	50.0	2.19

NEW

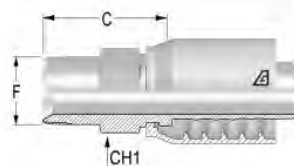

API Male NPT

Part Number	Dash Size	Hose ID Size		F Thread		C Cut-Off Factor (mm)	CH1 (mm)	Weight (lbs/each)
		(in)	(mm)	Dash Size	Size (in) - TPI			
F-3232-MAPI	32	2	50.8	32	2 - 11 1/2	114.5	65	4.50

Because we continually examine ways to improve our products, we reserve the right to alter specifications or discontinue products without prior notice.

AlfaCrimp One-Piece Fittings - F Series



HOSES

ONE-PIECE B SERIES

ONE-PIECE D SERIES

ONE-PIECE F & P SERIES

TWO-PIECE FERRULES (A & PFR SERIES)

TWO-PIECE INSERTS (A SERIES)

TWO-PIECE INTERLOCK FERRULES & INSERTS (X & Z SERIES)

QUICK RELEASE

ASSEMBLY EQUIPMENT

TECHNICAL INFORMATION

NEW

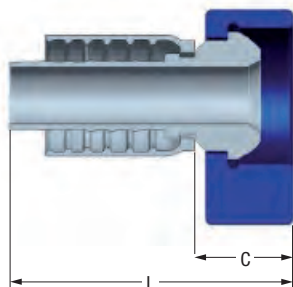

Male Hammer Union Fig. 1502 integral fitting with Lug Nut (One Piece No-Skive)
use with Alfabiotech 4000, 5000 and Flexor Rig Hoses

Part Number	Dash Size	Hose ID (in)	Hose ID (mm)	C Cut-Off (mm)	L Overall Length (mm)	Weight (lbs/each)
F-3232-MHUN	32	2	50.8	71.0	185.5	14.55

NEW

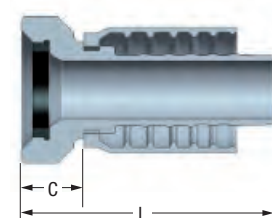

Female Hammer Union Fig. 1502 integral fitting with Rubber Ring (One Piece No-Skive)
use with Alfabiotech 4000, 5000 and Flexor Rig Hoses

Part Number	Dash Size	Hose ID (in)	Hose ID (mm)	C Cut-Off (mm)	L Overall Length (mm)	Weight (lbs/each)
F-3232-FHUN	32	2	50.8	67.5	182	5.52

Because we continually examine ways to improve our products, we reserve the right to alter specifications or discontinue products without prior notice.



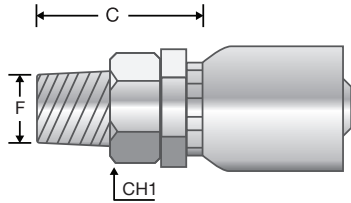

NEW

NPTF Male 60° Seat

Part Number	Dash Size	Hose ID Size		F Thread		C Cut-Off Factor (mm)	Hex Dia. CH1 (mm)	Weight (lbs/each)
		(in)	(mm)	Dash Size	Size (in) - TPI			
F02NPT2	02	1/8	3.2	02	1/8-27	18.8	12.7	0.035

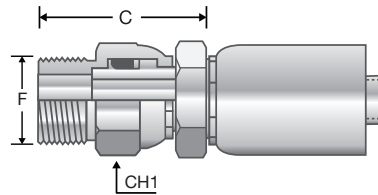

NEW

NPTF Swivel Male 60° Seat

Part Number	Dash Size	Hose ID Size		F Thread		C Cut-Off Factor (mm)	Hex Dia. CH1 (mm)	Weight (lbs/each)
		(in)	(mm)	Dash Size	Size (in) - TPI			
F02MSNPT2	02	1/8	3.2	02	1/8-27	33.02	12.7	0.058

HOSES

ONE-PIECE
B SERIES

ONE-PIECE
D SERIES

ONE-PIECE
F & P SERIES

TWO-PIECE FERRULES
(A & PFR SERIES)

TWO-PIECE INSERTS
(A-SERIES)

TWO-PIECE INTERLOCK
FERRULES & INSERTS
(X & Z-SERIES)

QUICK
RELEASE

ASSEMBLY
EQUIPMENT

TECHNICAL
INFORMATION

Because we continually examine ways to improve our products, we reserve the right to alter specifications or discontinue products without prior notice.

Stainless Steel One-Piece Fittings - P Series

HOSES
ONE-PIECE B SERIES
ONE-PIECE D SERIES
ONE-PIECE F & P SERIES
TWO-PIECE FERRULES (A & PFR SERIES)
TWO-PIECE INSERTS (A SERIES)
TWO-PIECE INTERLOCK FERRULES & INSERTS (X & Z SERIES)
QUICK RELEASE
ASSEMBLY EQUIPMENT
TECHNICAL INFORMATION

For use with PF321TC Series hose only

NEW

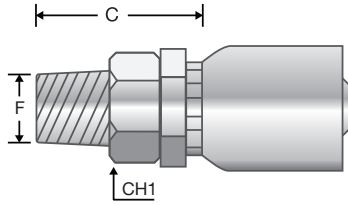

NPTF Male 60° Seat

Part Number	Dash Size	Hose ID Size		F Thread		C Cut-Off Factor (mm)	Hex Dia. CH1 (mm)	Weight (lbs/each)
		(in)	(mm)	Dash Size	Size (in) - TPI			
P-0302-MNPT-SS	03	3/16	4.8	02	1/8-27	26.6	17	0.100
P-0304-MNPT-SS	03	3/16	4.8	04	1/4-18	28.6	19	0.107
P-0404-MNPT-SS	04	1/4	6.4	04	1/4-18	28.6	22	0.117

For use with PF321TC Series hose only

NEW

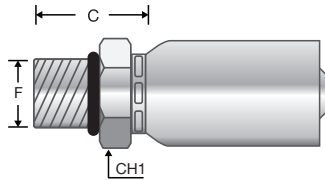

SAE Male O-Ring Boss

Part Number	Dash Size	Hose ID Size		F Thread		C Cut-Off Factor (mm)	Hex Dia. CH1 (mm)	Weight (lbs/each)
		(in)	(mm)	Dash Size	Size (in) - TPI			
P-0304-MORB-SS	03	3/16	4.8	04	7/16-20	22.2	17	0.105
P-0404-MORB-SS	04	1/4	6.4	04	7/16-20	22.2	19	0.115

For use with PF321TC Series hose only

NEW

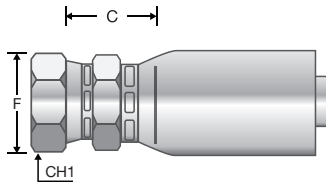

JIC Female 37° Seat

Part Number	Dash Size	Hose ID Size		F Thread		C Cut-Off Factor (mm)	Hex Dia. CH1 (mm)	Weight (lbs/each)
		(in)	(mm)	Dash Size	Size (in) - TPI			
P-0304-FJDH-SS	03	3/16	4.8	04	7/16-20	19.1	17	0.113
P-0404-FJDH-SS	04	1/4	6.4	04	7/16-20	19.1	19	0.123

Because we continually examine ways to improve our products, we reserve the right to alter specifications or discontinue products without prior notice.



	HOSES
	ONE-PIECE B SERIES
	ONE-PIECE D SERIES
	ONE-PIECE F & P SERIES
	TWO-PIECE FERRULES (A & PFR SERIES)
	TWO-PIECE INSERTS (A SERIES)
	TWO-PIECE INTERLOCK FERRULES & INSERTS (X & Z SERIES)
	QUICK RELEASE
	ASSEMBLY EQUIPMENT

Because we continually examine ways to improve our products, we reserve the right to alter specifications or discontinue products without prior notice.



Fitting Configuration Chart



HOSES
ONE-PIECE B SERIES
ONE-PIECE D SERIES
ONE-PIECE F & P SERIES
TWO-PIECE FERRULES (A & PFR SERIES)
TWO-PIECE INSERTS (A SERIES)
TWO-PIECE INTERLOCK FERRULES & INSERTS (X & Z SERIES)
QUICK RELEASE
ASSEMBLY EQUIPMENT
TECHNICAL INFORMATION

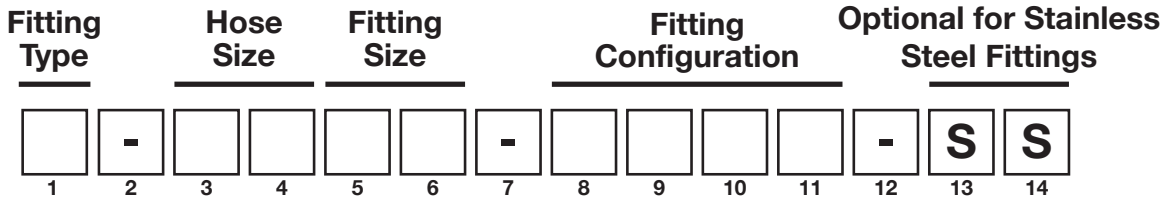

Fitting Type	Hose Size	Fitting Size
1-Piece Series		
B	-02 or 1/8"	-02 or 1/8"
D	-03 or 3/16"	-03 or 3/16"
F	-04 or 1/4"	-04 or 1/4"
P	-05 or 5/16"	-05 or 5/16"
2-Piece Series		
A	-06 or 3/8"	-06 or 3/8"
X	-08 or 1/2"	-08 or 1/2"
Z	-10 or 5/8"	-10 or 5/8"
V	-12 or 3/4"	-12 or 3/4"
	-14 or 7/8"	-14 or 7/8"
	-16 or 1"	-16 or 1"
	-20 or 1 1/4"	-20 or 1 1/4"
	-24 or 1 1/2"	-24 or 1 1/2"
	-32 or 2"	-32 or 2"
	-40 or 2 1/2"	-40 or 2 1/2"
	-48 or 3"	-48 or 3"

TYPE	SUFFIX	DESCRIPTION
NPTF	FNPR	Female National Pipe Rigid
	FPMS	Female Pipe Straight Mechanical Swivel
	FNPS	Female National Pipe Swivel
	MNPT	Male Pipe NPTF
	MNPS	Male National Pipe Swivel
	MPS9	Male Pipe Swivel 90 Degree
JIC	FJSH	Female JIC Single Hex Swivel
	FJDH	Female JIC Double Hex Swivel
	FJ45	Female JIC 45 Degree Swivel
	FJ9L	Female JIC 90 Degree Long Swivel
	FJ9M	Female JIC 90 Degree Medium Swivel
	FJ9S	Female JIC 90 Degree Short Swivel
	MJIC	Male JIC
	SAE	FSAE
FAE4		Female SAE 45 Degree Swivel
FAE9		Female SAE 90 Degree Swivel
MORB		Male O-Ring Boss
MOBS		Male O-Ring Boss Swivel
MBS9		Male O-Ring Boss Swivel 90 Degree
MIFL		Male Inverted Flare
MIF4		Male Inverted Flare 45 Degree
MIF9		Male Inverted Flare 90 Degree
MSAE		Male SAE
ORFS	F0FS	Female O-Ring Face Seal Swivel
	F045	Female O-Ring Face Seal 45 Degree Swivel
	F09L	Female O-Ring Face Seal 90 Degree Long Swivel
	F09M	Female O-Ring Face Seal 90 Degree Medium Swivel
	F09S	Female O-Ring Face Seal 90 Degree Short Swivel
	MOFS	Male O-Ring Face Seal
SAE Flange Code 61	C61S	Code 61 Flange Straight
	C612	Code 61 Flange 22.5 Degree
	C613	Code 61 Flange 30 Degree
	C614	Code 61 Flange 45 Degree
	C616	Code 61 Flange 60 Degree
	C619	Code 61 Flange 90 Degree
SAE Flange Code 62	C62S	Code 62 Flange Straight
	C624	Code 62 Flange 45 Degree
	C629	Code 62 Flange 90 Degree

Fitting Configuration Chart – Fitting Type Explanation

B Series – One-piece non-skive crimp fitting for all braided hoses up to 1" ID.

D Series – One-piece non-skive crimp fitting for wire braided hoses above 1" ID and 4 wire spiral hose Alfabiotech 3000 1 1/4" ID thru 2" ID and Alfabiotech 4000 3/8" ID thru 1 1/4" ID.

F Series – One-piece non-skive crimp fitting for Alfabiotech 4000 2" ID, Alfabiotech 5000 3/4" ID thru 2" ID and Alfabiotech 6000 3/4" thru 1 1/4".

P Series – One-piece non-skive crimp fitting for use with Piranhaflex PF321TC hose only.

A Series – Two-piece insert for all wire and textile braided hoses, thermoplastic hose, Flexor 4 and PTFE hose 3/16" thru 2" and Alfabiotech 3000 1 1/4" and 1 1/2", Alfabiotech 4000 3/8" thru 1 1/4" along with some smaller ID spiral wire reinforced hoses.

X Series – Two-piece Interlock insert for spiral wire reinforced hoses. Requires both internal and external skiving and a XF1 or XF2 Interlock ferrule to perform properly.

Z Series – Two-piece Interlock insert for Alfatech 6000 (AT6K) in 2" size only. Requires both internal and external skiving and a ZF1 Interlock ferrule to perform properly.

V Series – Two-piece insert for Flexor Rig/Alfabiotech 2000, 2 1/2" and 3" ID size only. Requires a VS4 skive ferrule to perform properly.

Because we continually examine ways to improve our products, we reserve the right to alter specifications or discontinue products without prior notice.



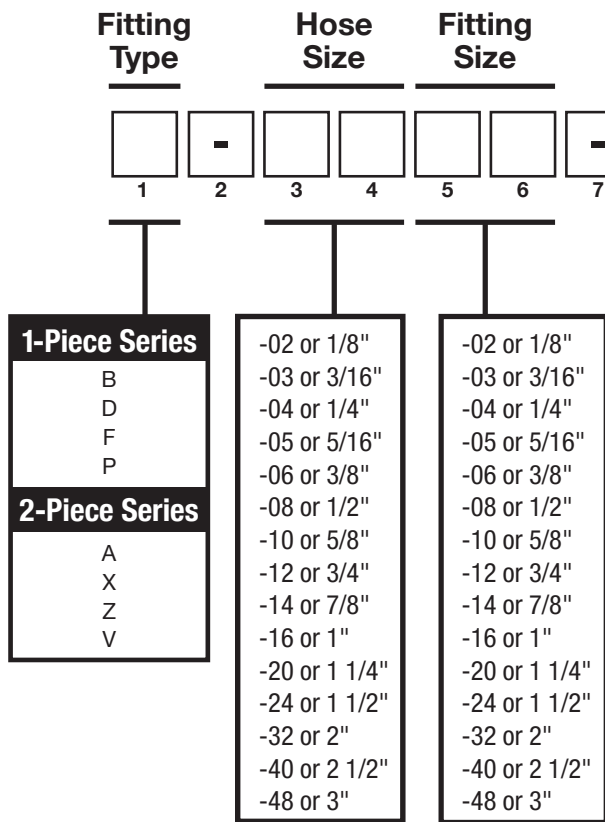

Fitting Configuration				Optional for Stainless Steel Fittings							
TYPE	SUFFIX	DESCRIPTION		8	9	10	11	12	13	14	
Caterpillar Flange	CFLS	CAT Flange Straight									
	CFL2	Cat Flange 22.5 Degree									
	CFL3	Cat Flange 30 Degree									
	CFL4	CAT Flange 45 Degree									
	CFL6	Cat Flange 60 Degree									
	CFL7	Cat Flange 67.5 Degree									
	CFL9	CAT Flange 90 Degree									
	BSP	BBAN	BSP Banjo								
		FBC9	Female BSP Compact 90 Degree Swivel								
FBFS		Female BSP Flat Seat Swivel									
FBP0		Female British Pipe Parallel With O-Ring Swivel									
FBO4		Female British Pipe Parallel With O-Ring 45 Degree Swivel									
FBO9		Female British Pipe Parallel With O-Ring 90 Degree Swivel									
FBPP		Female British Pipe Parallel Swivel									
FBP4		Female British Pipe Parallel 45 Degree Swivel									
FBP9		Female British Pipe Parallel 90 Degree Swivel									
MBFS		Male BSP Flat Seat									
MBPP		Male British Pipe Parallel									
MBPT	Male British Pipe Tapered/JIS										
Metric	FMFS	Female Metric French Swivel									
	FMOH	Female Metric O-Ring Heavy Swivel									
	FM4H	Female Metric O-Ring 45 Degree Heavy Swivel									
	FM9H	Female Metric O-Ring 90 Degree Heavy Swivel									
	FMOL	Female Metric O-Ring Light Swivel									
	FM4L	Female Metric O-Ring 45 Degree Light Swivel									
	FM6S	Female Metric 60 Degree Seat DIN 3863									
	FM9L	Female Metric O-Ring 90 Degree Light Swivel									
	MBAN	Metric Banjo									
	MMFR	Male Metric French Solid									
	MMSH	Male Metric Solid-Heavy									
MMSL	Male Metric Solid-Light										
MSPS	Metric Stand Pipe Straight										
MSP4	Metric Stand Pipe 45 Degree										
MSP9	Metric Stand Pipe 90 Degree										
JIS	FJIS	Female JIS Swivel									
	FJS4	Female JIS 45 Degree Swivel									
	FJS9	Female JIS 90 Degree Swivel									
	FKOS	Female Komatsu Swivel									
	KFST	Komatsu Flange Straight									
	KF45	Komatsu Flange 45 Degree									
KF90	Komatsu Flange 90 Degree										
API	FHUN	Female Hammer Union									
	MAPI	Male API Pipe Thread									
	MHUN	Male Hammer Union									
Other	BTTF	Bite Type Tube Fitting									
	FGRT	Female Grease Tap									
	FPWS	Female Pressure Washer Swivel									
	HMEN	Hose Mender									

Fitting Configuration Chart – Fitting Type Explanation

B Series – One-piece non-skive crimp fitting for all braided hoses up to 1" ID.

D Series – One-piece non-skive crimp fitting for wire braided hoses above 1" ID and 4 wire spiral hose Alfabiotech 3000 1 ¼" ID thru 2" ID and Alfabiotech 4000 ¾" ID thru 1 ¼" ID.

F Series – One-piece non-skive crimp fitting for Alfabiotech 4000 2" ID, Alfabiotech 5000 ¾" ID thru 2" ID and Alfabiotech 6000 ¾" thru 1 ¼".

P Series – One-piece non-skive crimp fitting for use with Piranhaflex PF321TC hose only.

A Series – Two-piece insert for all wire and textile braided hoses, thermoplastic hose, Flexor 4 and PTFE hose ¾" thru 2" and Alfabiotech 3000 1 ¼" and 1 ½", Alfabiotech 4000 ¾" thru 1 ¼" along with some smaller ID spiral wire reinforced hoses.

X Series – Two-piece Interlock insert for spiral wire reinforced hoses. Requires both internal and external skiving and a XF1 or XF2 Interlock ferrule to perform properly.

Z Series – Two-piece Interlock insert for Alfatech 6000 (AT6K) in 2" size only. Requires both internal and external skiving and a ZF1 Interlock ferrule to perform properly.

V Series – Two-piece insert for Flexor Rig/Alfabiotech 2000, 2 ½" and 3" ID size only. Requires a VS4 skive ferrule to perform properly.

Because we continually examine ways to improve our products, we reserve the right to alter specifications or discontinue products without prior notice.

HOSES
ONE-PIECE B SERIES
ONE-PIECE D SERIES
ONE-PIECE F & P SERIES
TWO-PIECE FERRULES (A & PFR SERIES)
TWO-PIECE INSERTS (A-SERIES)
TWO-PIECE INTERLOCK FERRULES & INSERTS (X & Z-SERIES)
QUICK RELEASE
ASSEMBLY EQUIPMENT
TECHNICAL INFORMATION

Hose Ferrule Part Number Configurator



- HOSES
- ONE-PIECE B SERIES
- ONE-PIECE D SERIES
- ONE-PIECE F & P SERIES
- TWO-PIECE FERRULES (A & PFR SERIES)
- TWO-PIECE INSERTS (A SERIES)
- TWO-PIECE INTERLOCK FERRULES & INSERTS (X & Z SERIES)
- QUICK RELEASE
- ASSEMBLY EQUIPMENT
- TECHNICAL INFORMATION

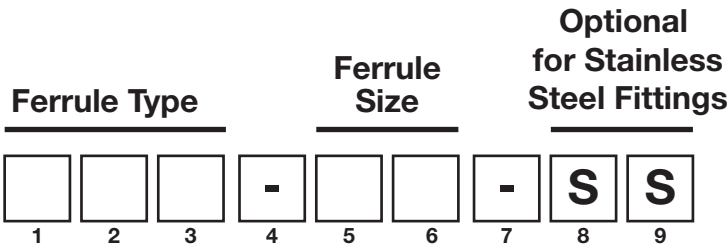

No Skive Ferrule	AF1 AF2 AF4 AFT AFX PFR - Piranhaflex PFR3 - Piranhaflex PFR7 - Piranhaflex
Skive Ferrule	AS4 VS4
Interlock Ferrule	XF1 XF2 ZF1

Fitting Configuration Chart – Ferrule Type Explanation

AF1 – Two piece non-skive ferrule for use with “A” insert on single wire braided and compact hydraulic hoses, Flexor 1 (TR1MT, T1SNTT), Flexopak 2 (TF2MT, TF2ST, TF2LT), Alfatech 3000 (AT3KMT, AT3KST), Alfajet 210 (TAJ3BK/BU) and Alfajet 400 (TAJ5BK/BU).

AF2 – Two piece non-skive ferrule for use with “A” insert on double wire braided hydraulic hoses, Flexor 2 (TR2MT, T2SNTT).

AF4 – Two piece non-skive ferrule for use with “A” insert on spiral wire reinforced hoses Alfabiotech ABT3K and ABT4K

AFT – H2200TFO - Two piece non-skive stainless steel ferrule for use with “A” insert on stainless braided PTFE hose (TR14TB).

AFX – Two piece non-skive ferrule for use with “A” insert on textile braided hydraulic hose Flexor 5 (TR5) and Flexor 4 (TR4XF).

PFR, PFR3 and PFR7 – Piranhaflex – Two piece non-skive ferrule for use with “A” insert on all PiranhaFlex hydraulic hoses, R7, R8 and R18 styles.

AS4 – Two piece skive ferrule for use with “A” insert on spiral reinforced hoses Alfabiotech ABT4K, ABT5K, ABT6K.

VS4 – Two piece skive ferrule for use with “V” insert on Flexor Rig-40 and 48.

XF1 – Two piece Interlock ferrule for use with “X” Interlock insert on spiral wire reinforced hoses. Requires internal and external skiving.

XF2 – Two piece Interlock ferrule for use with “X” Interlock insert on spiral wire reinforced hoses. Requires internal and external skiving.

ZF1 – Two piece Interlock ferrule for use with “Z” Interlock insert on Alfatech 6000-32, 2” size. Requires internal and external skiving.

Because we continually examine ways to improve our products, we reserve the right to alter specifications or discontinue products without prior notice.



Ferrule Selection Chart

No Skive Ferrule For A Series Fittings



HOSES

ONE-PIECE B SERIES

ONE-PIECE D SERIES

ONE-PIECE F & P SERIES

TWO-PIECE FERRULES (A & PFR SERIES)

TWO-PIECE INSERTS (A SERIES)

TWO-PIECE INTERLOCK FERRULES & INSERTS (X & Z SERIES)

QUICK RELEASE

ASSEMBLY EQUIPMENT

TECHNICAL INFORMATION

Series	Description	Page No.	Size	-02	-03	-04	-05	-06	-08	-10	-12	-16	-20	-24	-32	-40	-48
			DIN	3	5	6	8	10	12	16	19	25	32	38	51	63	76
			(in)	1/8	3/16	1/4	5/16	3/8	1/2	5/8	3/4	1	1 1/4	1 1/2	2	2 1/2	3
ABT3K	ALFABIOTECH 3000 MINETUFF	30											AF4	AF4			
ABT4K	ALFABIOTECH 4000 MINETUFF	31									AF4	AF4	AF4				
AT3KST	ALFATECH 3000 SUPERTUFF	37				AF1		AF1	AF1		AF1	AF1					
TR1MT	1SN/R1AT MINETUFF	23				AF1	AF1	AF1	AF1	AF1	AF1	AF1	AF1	AF1			
T1SNTT	1SN/R1AT TEMP TECH	43				AF1		AF1	AF1		AF1	AF1	AF1	AF1	AF1		
TF2LT	2SC/R16 LOW TEMP	66				AF1		AF1	AF1	AF1	AF1	AF1					
TF2MT	2SC/R16 MINETUFF	25				AF1		AF1	AF1	AF1	AF1	AF1	AF1	AF1	AF1		
TF2ST	2SC/R16 SUPERTUFF	38				AF1		AF1	AF1	AF1	AF1	AF1					
TR2MT	2SN/R2AT MINETUFF	24						AF2	AF2	AF2	AF2	AF2	AF2	AF2	AF2	AF2	
T2SNTT	2SN/R2AT TEMP TECH	44				AF2		AF2	AF2	AF2	AF2	AF2	AF2	AF2	AF2	AF2	
TAJ3BK	ALFAJET 210	67				AF1	AF1	AF1	AF1								
TAJ3BU	ALFAJET 210	67				AF1	AF1	AF1	AF1								
TAJ5BK	ALFAJET 400	68				AF1	AF1	AF1	AF1								
TAJ5BU	ALFAJET 400	68				AF1	AF1	AF1	AF1								
PF151R3	PIRANHAFLEX 100R3	46				PFR3-04	PFR3-05	PFR3-06	PFR3-08								
PF427	PIRANHAFLEX 100R18	57				PFR-04		PFR-06	PFR-08								
PF427NC	PIRANHAFLEX 100R18	57				PFR-04		PFR-06	PFR-08								
PF267	PIRANHAFLEX 100R7	52				PFR-03	PFR-04	PFR7-05	PFR-06	PFR-08		PFR-12					
PF267NC	PIRANHAFLEX 100R7	52				PFR-03	PFR-04	PFR7-05	PFR-06	PFR-08		PFR-12					
PF354	PIRANHAFLEX 100R7	48				F02-02	PFR-03	PFR-04	PFR7-05	PFR-06	PFR-08		PFR-12				
PF354NC	PIRANHAFLEX 100R7	48				F02-02	PFR-03	PFR-04	PFR7-05	PFR-06	PFR-08		PFR-12				
PF367	PIRANHAFLEX 100R7	51				PFR-03	PFR-04	PFR7-05	PFR-06	PFR-08		PFR-12					
PF367NC	PIRANHAFLEX 100R7	51				PFR-03	PFR-04	PFR7-05	PFR-06	PFR-08		PFR-12					
PFAN388NC	PIRANHAFLEX 100R7	53				PFR-04		PFR-06	PFR-08								
PFLT364	PIRANHAFLEX 100R7	54				PFR-04		PFR-06	PFR-08								
PFP354	PIRANHAFLEX 100R7	49				PFR-04		PFR-06	PFR-08								
PFP354NC	PIRANHAFLEX 100R7	50				PFR-04		PFR-06	PFR-08								
PF628	PIRANHAFLEX 100R8	55				PFR-04		PFR-06	PFR-08		PFR-12						

Because we continually examine ways to improve our products, we reserve the right to alter specifications or discontinue products without prior notice.



Ferrule Selection Chart

No Skive Ferrule For A Series Fittings

Series	Description	Page No.	Size	-02	-03	-04	-05	-06	-08	-10	-12	-16	-20	-24	-32	-40	-48
			DIN	3	5	6	8	10	12	16	19	25	32	38	51	63	76
			(in)	1/8	3/16	1/4	5/16	3/8	1/2	5/8	3/4	1	1 1/4	1 1/2	2	2 1/2	3
PF628NC	PIRANHAFLEX 100R8	55				PFR-04		PFR-06	PFR-08		PFR-12						
PF415CP	PIRANHAFLEX	47				PFR3-04	PFR3-05	PFR3-06	PFR3-08								
PF528	PIRANHAFLEX 100R8	56															
PF321TC	PIRANHAFLEX SPECIALTY	60			PFR-03	PFR-04											
PF344LMT	PIRANHAFLEX SPECIALTY	61				PFR-04		PFR-06	PFR-08		AFX-12	AFX-16					
TR4XF	R4 XTRA-FLEXIBLE	63									AFX	AFX	AFX	AFX	AFX		
TR14TB	R14 PTFE	65			AFT	AFT	AFT	AFT	AFT	AFT	AFT	AFT					

Series	Description	Page No.	Size	-04	-05	-06	-08	-10	-12	-16	-20	-24	-32
			DIN	5	6	8	10	12	16	22	29	35	46
			(in)	3/16	1/4	5/16	13/32	1/2	5/8	7/8	1 1/8	1 3/8	1 13/16
TR5TT	R5 TEMP TECH	45		AFX-03	AFX-04	AFX-05	AFX-06	AFX-08	AFX-10	AFX-12	AFX-16	AFX-20	AFX-32
TR5	R5	64		AFX-03	AFX-04	AFX-05	AFX-06	AFX-08	AFX-10	AFX-12	AFX-16	AFX-20	AFX-32

Because we continually examine ways to improve our products, we reserve the right to alter specifications or discontinue products without prior notice.



- HOSES
- ONE-PIECE B SERIES
- ONE-PIECE D SERIES
- ONE-PIECE F & P SERIES
- TWO-PIECE FERRULES (A & PFR SERIES)
- TWO-PIECE INSERTS (A-SERIES)
- TWO-PIECE INTERLOCK FERRULES & INSERTS (X & Z-SERIES)
- QUICK RELEASE
- ASSEMBLY EQUIPMENT
- TECHNICAL INFORMATION

Ferrule Selection Chart

Skive Ferrule For Standard Fittings



- HOSES
- ONE-PIECE B SERIES
- ONE-PIECE D SERIES
- ONE-PIECE F & P SERIES
- TWO-PIECE FERRULES (A & PFR SERIES)
- TWO-PIECE INSERTS (A SERIES)
- TWO-PIECE INTERLOCK FERRULES & INSERTS (X & Z SERIES)
- QUICK RELEASE
- ASSEMBLY EQUIPMENT
- TECHNICAL INFORMATION









Series	Description	Page No.	Size	-03	-04	-05	-06	-08	-10	-12	-16	-20	-24	-32	-40	-48
			DIN	5	6	8	10	12	16	19	25	32	38	51	63	76
			(in)	3/16	1/4	5/16	3/8	1/2	5/8	3/4	1	1 1/4	1 1/2	2	2 1/2	3
ABT2K	ALFABIOTECH 2000 MINETUFF	29													VS4	VS4
ABT3K	ALFABIOTECH 3000 MINETUFF	30										AS4	AS4			
ABT4K	ALFABIOTECH 4000 MINETUFF	31								AS4	AS4	AS4				
ABT5K	ALFABIOTECH 5000 MINETUFF	32							AS4	AS4	AS4					
ABT5KST	ALFABIOTECH 5000 SUPERTUFF	39							AS4	AS4	AS4					
ABTP5K	ALFABIOTECH 5500 MINETUFF	33								AS4						
ABT6K	ALFABIOTECH 6000 MINETUFF	34			AS4		AS4	AS4								
ABT6KST	ALFABIOTECH 6000 SUPERTUFF	40			AS4		AS4	AS4								
AF3B	ALFAFOREST MINETUFF	27					AS4	AS4								
WB10	WATERBLAST MINETUFF	72					AS4									

Because we continually examine ways to improve our products, we reserve the right to alter specifications or discontinue products without prior notice.





Two-Piece A Series Ferrules Index

A Series Ferrules – Non Skive

	AF1	163
	AF2	163
	AF4	163
	AFT	164
	AFX	164
	PFR - Piranhaflex™	165
	PFR3 - Piranhaflex™	165
	PFR7 - Piranhaflex™	165

A Series Ferrules – Skive

	AS4	166
	VS4	166

Because we continually examine ways to improve our products, we reserve the right to alter specifications or discontinue products without prior notice.

HOSES
ONE-PIECE B SERIES
ONE-PIECE D SERIES
ONE-PIECE F & P SERIES
TWO-PIECE FERRULES (A & PFR SERIES)
TWO-PIECE INSERTS (A SERIES)
TWO-PIECE INTERLOCK FERRULES & INSERTS (X & Z SERIES)
QUICK RELEASE
ASSEMBLY EQUIPMENT
TECHNICAL INFORMATION

A Series Non-Skive Ferrules

AF1

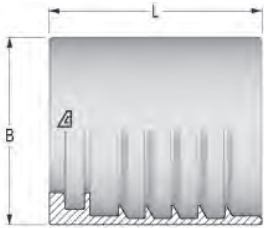

Part Number	Dash Size	Hose ID Size		B OD (mm)	L Length (mm)	Weight (lbs/each)
		(in)	(mm)			
AF1-03	03	3/16	4.8	19.0	24.0	0.05
AF1-04	04	1/4	6.4	22	24.7	0.06
AF1-05	05	5/16	7.9	23	24.7	0.07
AF1-06	06	3/8	9.5	26	29.7	0.10
AF1-08	08	1/2	12.7	29	30.5	0.11
AF1-10	10	5/8	15.9	32	30.5	0.12
AF1-12	12	3/4	19.0	36	36.0	0.17
AF1-16	16	1	25.4	44	36.7	0.24
AF1-20	20	1 1/4	31.8	53	48.6	0.40
AF1-24	24	1 1/2	38.1	61	48.6	0.50
AF1-32	32	2	50.8	75	48.6	0.70

NOTE: Also available in stainless steel in some sizes. To order stainless, add -SS to the end of the part number. Example: A-0606-XXXX-SS

AF2

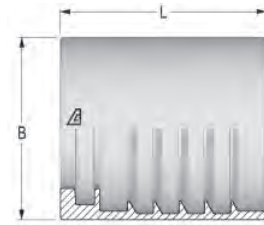

Part Number	Dash Size	Hose ID Size		B OD (mm)	L Length (mm)	Weight (lbs/each)
		(in)	(mm)			
AF2-03	03	3/16	4.8	21	24.0	0.06
AF2-04	04	1/4	6.4	23	24.7	0.07
AF2-05	05	5/16	7.9	25	24.7	0.08
AF2-06	06	3/8	9.5	27	29.7	0.10
AF2-08	08	1/2	12.7	30	30.5	0.12
AF2-10	10	5/8	15.9	33	30.5	0.13
AF2-12	12	3/4	19.0	37	36.0	0.18
AF2-16	16	1	25.4	45	36.7	0.24
AF2-20	20	1 1/4	31.8	56	48.6	0.45
AF2-24	24	1 1/2	38.1	64	48.5	0.55
AF2-32	32	2	50.8	76	48.6	0.70

NOTE: Also available in stainless steel in some sizes. To order stainless, add -SS to the end of the part number. Example: A-0606-XXXX-SS

AF4

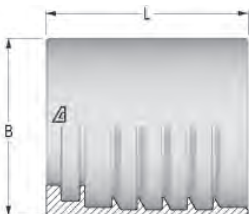

Part Number	Dash Size	Hose ID Size		B OD (mm)	L Length (mm)	Weight (lbs/each)
		(in)	(mm)			
AF4-06	06	3/8	9.5	30	28.0	0.11
AF4-08	08	1/2	12.7	34	33.9	0.16
AF4-10	10	5/8	15.9	38	36.6	0.20
AF4-12	12	3/4	19.0	42	39.5	0.28
AF4-16	16	1	25.4	50	45.4	0.51
AF4-20	20	1 1/4	31.8	62	50.1	0.55
AF4-24	24	1 1/2	38.1	68	59.0	0.71

Because we continually examine ways to improve our products, we reserve the right to alter specifications or discontinue products without prior notice.

Two-Piece Fittings

- AFT, AFX Series



HOSES
ONE-PIECE B SERIES
ONE-PIECE D SERIES
ONE-PIECE F & P SERIES
TWO-PIECE FERRULES (A & PFR SERIES)
TWO-PIECE INSERTS (A SERIES)
TWO-PIECE INTERLOCK FERRULES & INSERTS (X & Z SERIES)
QUICK RELEASE
ASSEMBLY EQUIPMENT
TECHNICAL INFORMATION

A Series Non-Skive Ferrules

AFT – Stainless Steel

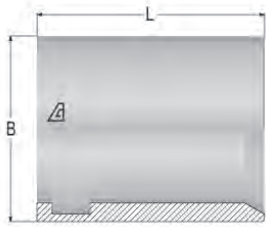

Part Number	Dash Size	Hose ID Size		B OD (mm)	L Length (mm)	Weight (lbs/each)
		(in)	(mm)			
AFT-03	03	3/16	4.8	14.0	20	0.02
AFT-04	04	1/4	6.4	15.0	25	0.03
AFT-05	05	5/16	7.9	17.2	25	0.04
AFT-06	06	3/8	9.5	22.0	25	0.07
AFT-08	08	1/2	12.7	25.0	30	0.08
AFT-10	10	5/8	15.9	30.0	33	0.11
AFT-12	12	3/4	19.0	35.0	37	0.15
AFT-16	16	1	25.4	42.0	45	0.26
AFT-20	20	1 1/4	31.8	50.0	48	0.34
AFT-24	24	1 1/2	38.1	57.0	58	0.48
AFT-32	32	2	50.8	73.0	67	0.73

AFX



Part Number	Dash Size	Hose ID Size		B OD (mm)	L Length (mm)	Weight (lbs/each)
		(in)	(mm)			
AFX-03	03	3/16	4.8	21	21.5	0.05
AFX-04	04	1/4	6.4	23	24.7	0.07
AFX-05	05	5/16	7.9	25	24.7	0.08
AFX-06	06	3/8	9.5	27	29.7	0.10
AFX-08	08	1/2	12.7	30	30.5	0.11
AFX-10	10	5/8	15.9	34	35.5	0.15
AFX-12	12	3/4	19.0	38	36.0	0.17
AFX-16	16	1	25.4	48	42.5	0.28
AFX-20	20	1 1/4	31.8	53	56.5	0.42
AFX-24	24	1 1/2	38.1	60	61.5	0.45
AFX-32	32	2	50.8	76	73.5	0.82

NOTE: Also available in stainless steel in some sizes. To order stainless, add -SS to the end of the part number. Example: A-0606-XXXX-SS

Because we continually examine ways to improve our products, we reserve the right to alter specifications or discontinue products without prior notice.



PFR Non-Skive Ferrules

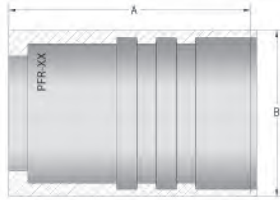

PFR - Piranhaflex™

Part Number	Dash Size	Hose ID Size		B OD (mm)	L Length (mm)	Weight (lbs/each)
		(in)	(mm)			
PFR-03	03	3/16	4.7	14.9	24.0	0.03
PFR-04	04	1/4	6.4	17.0	29.0	0.04
PFR7-05*	05	5/16	7.9	19.0	29.0	0.04
PFR-06	06	3/8	9.5	21.0	31.0	0.05
PFR-08	08	1/2	12.7	25.4	36.0	0.06
PFR-12	12	3/4	19.05	31.8	45.2	0.11

* PFR7-05 ferrules are to be used only with SAE 100R7 hoses!

NEW

PFR3 - Piranhaflex™



Part Number	Dash Size	Hose ID Size		B OD (mm)	L Length (mm)	Weight (lbs/each)
		(in)	(mm)			
PFR3-04	04	1/4	6.4	14.75	28.9	0.03
PFR3-05	05	5/16	7.9	17.4	28.8	0.04
PFR3-06	06	3/8	9.5	19.0	28.8	0.04
PFR3-08	08	1/2	12.7	23.7	36.3	0.06

Because we continually examine ways to improve our products, we reserve the right to alter specifications or discontinue products without prior notice.

Two-Piece Fittings - AS4, VS4 Series



HOSES
ONE-PIECE B SERIES
ONE-PIECE D SERIES
ONE-PIECE F & P SERIES
TWO-PIECE FERRULES (A & PFR SERIES)
TWO-PIECE INSERTS (A SERIES)
TWO-PIECE INTERLOCK FERRULES & INSERTS (X & Z SERIES)
QUICK RELEASE
ASSEMBLY EQUIPMENT
TECHNICAL INFORMATION

A Series Skive Ferrules

AS4

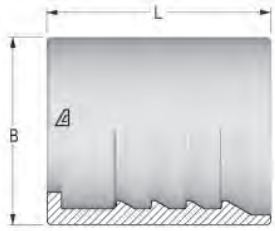

Part Number	Dash Size	Hose ID Size		B OD (mm)	L Length (mm)	Weight (lbs/each)
		(in)	(mm)			
AS4-04	04	1/4	6.4	22	26.3	0.07
AS4-06	06	3/8	9.5	25	28.5	0.09
AS4-08	08	1/2	12.7	29	34.7	0.14
AS4-10	10	5/8	15.9	32	37.5	0.17
AS4-12	12	3/4	19.0	36	41.5	0.21
AS4-16	16	1	25.4	45	47.7	0.37
AS4-20	20	1 1/4	31.8	58	54.6	0.88
AS4-24	24	1 1/2	38.1	67	61.0	1.08
AS4-32	32	2	50.8	82	75.1	1.76

VS4

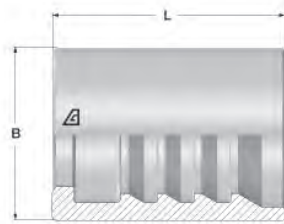

Part Number	Dash Size	Hose ID Size		B OD (mm)	L Length (mm)	Weight (lbs/each)
		(in)	(mm)			
VS4-40	40	2 1/2	63.5	95	84.0	3.85
VS4-48	48	3	76.2	95	84.0	4.35

Because we continually examine ways to improve our products, we reserve the right to alter specifications or discontinue products without prior notice.





Lined area for notes.

HOSES

ONE-PIECE B SERIES

ONE-PIECE D SERIES

ONE-PIECE F & P SERIES

TWO-PIECE FERRULES (A & PFR SERIES)

TWO-PIECE INSERTS (A SERIES)

TWO-PIECE INTERLOCK FERRULES & INSERTS (X & Z SERIES)

QUICK RELEASE

ASSEMBLY EQUIPMENT

Because we continually examine ways to improve our products, we reserve the right to alter specifications or discontinue products without prior notice.





HOSES
ONE-PIECE B SERIES
ONE-PIECE D SERIES
ONE-PIECE F & P SERIES
TWO-PIECE FERRULES (A & PFR SERIES)
TWO-PIECE INSERTS (A SERIES)
TWO-PIECE INTERLOCK FERRULES & INSERTS (X & Z SERIES)
QUICK RELEASE
ASSEMBLY EQUIPMENT
TECHNICAL INFORMATION

Two-Piece A Series Fittings Index

A Series Inserts – US End Configurations

Other

	Grease Fitting	198
	Bite Type Tube Fitting.....	198
	Hose Mender.....	196

API

	API Male NPT Extended Hex	196
---	---------------------------------	-----

NPTF

	NPTF Male 60° Seat.....	172
---	-------------------------	-----

	NPTF Male Swivel 60° Seat.....	173
---	--------------------------------	-----

	90° Compact NPTF Male Swivel 60° Seat	173
---	---	-----

	NPTF Female Rigid.....	174
---	------------------------	-----

	NPSM Female Swivel 60° Seat	174
---	-----------------------------------	-----

JIC

	JIC Male 37° Seat	177
---	-------------------------	-----

	JIC Female 37° Seat	178
---	---------------------------	-----

	JIC Female 37° Seat – Double Hex	179
---	--	-----

A Series Inserts – US End Configurations (continued)

	45° JIC Female Swivel 37° Seat.....	182
---	-------------------------------------	-----

	90° JIC Female Swivel 37° Seat Short Drop	183
---	---	-----

	90° JIC Female Swivel 37° Seat Medium Drop.....	184
---	---	-----







	90° JIC Female Swivel 37° Seat Long Drop.....	185
---	---	-----

Because we continually examine ways to improve our products, we reserve the right to alter specifications or discontinue products without prior notice.







Two-Piece A Series Fittings Index

A Series Inserts – US End Configurations







SAE

	45° Female SAE 45°	181
	90° Female SAE 45°	181
	SAE Male O-Ring Boss Swivel	175
	90° Compact SAE Male Swivel O-Ring Boss.....	175
	SAE 45° Male.....	180
	SAE Male O-Ring Boss	176
	SAE Female 45° Seat – Double Hex	180

ORFS

	ORFS Male	186
	ORFS Female - Double Hex..	186 - 187
	45° ORFS Female Swivel.....	187
	90° ORFS Female Swivel Short Drop	188
	90° ORFS Female Swivel Medium Drop	189
	90° ORFS Female Swivel Long Drop	190

SAE Flange Code 61

	O-Ring Flange SAE J518 Code 61	191
	22° O-Ring Flange SAE J518 Code 61	191
	30° O-Ring Flange SAE J518 Code 61	192
	45° O-Ring Flange SAE J518 Code 61	192
	60° O-Ring Flange SAE J518 Code 61	193
	90° O-Ring Flange SAE J518 Code 61	193
	Split Flange Clamps SAE J518 Code 61 – 3000 PSI.....	195

SAE Flange Code 62

	O-Ring Flange SAE J518 Code 62	194
	45° O-Ring Flange SAE J518 Code 62	194
	90° O-Ring Flange SAE J518 Code 62	195
	Split Flange Clamps SAE J518 Code 62 – 6000 PSI	198











Because we continually examine ways to improve our products, we reserve the right to alter specifications or discontinue products without prior notice.

HOSES
ONE-PIECE B SERIES
ONE-PIECE D SERIES
ONE-PIECE F & P SERIES
TWO-PIECE FERRULES (A & PFR SERIES)
TWO-PIECE INSERTS (A SERIES)
TWO-PIECE INTERLOCK FERRULES & INSERTS (X & Z SERIES)
QUICK RELEASE
ASSEMBLY EQUIPMENT
TECHNICAL INFORMATION



Two-Piece A Series Fittings Index

A Series Inserts – International End Configurations













BSP

	BSP Male Parallel 60° Seat 199
	BSP Male Flat Seat.....200
	BSP/JIS Male Tapered200
	BSP Banjo - RNR.....201
	BSPP Bolt.....201
	BSP O-Ring Female Swivel 60° Cone202
	45° BSP O-Ring Female Swivel 60° Cone.....203
	90° BSP Compact Female Elbow 60° Cone.....204
	90° BSP O-Ring Female Swivel 60° Cone..... 204-205
	BSP Female Swivel Flat Seat205

Metric

	Metric Male 24° Seat – DIN 3853 Light..... 206
	Metric O-Ring Female Swivel 24° Seat - DIN 3865 Light 207

Metric (continued)

	45° Metric O-Ring Female Swivel 24° Seat - DIN 3865 Light..... 207
	Metric Male 24° Seat – DIN 3853 Heavy..... 208
	90° Metric O-Ring Female Swivel 24° Seat - DIN 3865 Light..... 208
	Metric O-Ring Female Swivel 24° Seat – DIN 3853 Heavy..... 209
	45° Metric O-Ring Female Swivel 24° Seat - DIN 3865 Heavy 209
	Metric Swivel Female 60° Cone – DIN 3863 210
	90° Metric O-Ring Female Swivel 24° Seat - DIN 3865 Heavy 210
	Metric Banjo..... 211
	Metric Bolt..... 211
	Metric Straight Standpipe..... 212
	45° Metric Bent Tube Standpipe - DIN 2353..... 213
	90° Metric Bent Tube Standpipe - DIN 2353..... 213-214

Because we continually examine ways to improve our products, we reserve the right to alter specifications or discontinue products without prior notice.

Two-Piece A Series Fittings Index

A Series Inserts – International End Configurations

Metric (continued)

 **Metric Male French Type216**

 **Metric Female French Type217**

DIN

 **Nut DIN 24° Light214**

 **Nut DIN 24° Heavy215**

 **Double Cutting Ring DIN 24°
Light 215**

 **Double Cutting Ring DIN 24°
Heavy 216**

JIS

 **JIS Female Swivel 30° Seat – B 8363
Type F217**

 **Komatsu Female.....218**

 **Komatsu Straight O-Ring Flange...218**

 **Komatsu 45° O-Ring Flange219**

 **Komatsu 90° O-Ring Flange.....219**

Other

 **Pressure Wash Female (Type K).....219**

Two-Piece Fittings - A Series



Inserts for two-piece fittings – US End Configurations

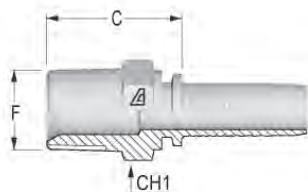

NPTF Male 60° Seat

Part Number	Dash Size	Hose ID Size		F Thread		C Cut-Off Factor (mm)	Hex Dia. CH1 (mm)	Weight (lbs/each)
		(in)	(mm)	Dash Size	Size (in) - TPI			
A-0302-MNPT	03	3/16	4.8	02	1/8-27	19.8	12	0.03
A-0304-MNPT	03	3/16	4.8	04	1/4-18	21.3	17	0.04
A-0402-MNPT	04	1/4	6.4	02	1/8-27	21.3	14	0.04
A-0404-MNPT	04	1/4	6.4	04	1/4-18	26.8	17	0.06
A-0406-MNPT	04	1/4	6.4	06	3/8-18	27.8	19	0.08
A-0408-MNPT	04	1/4	6.4	08	1/2-14	28.6	22	0.20
A-0504-MNPT	05	5/16	7.9	04	1/4-18	26.8	17	0.07
A-0506-MNPT	05	5/16	7.9	06	3/8-18	27.8	19	0.11
A-0604-MNPT	06	3/8	9.5	04	1/4-18	26.8	17	0.07
A-0606-MNPT	06	3/8	9.5	06	3/8-18	27.8	19	0.09
A-0608-MNPT	06	3/8	9.5	08	1/2-14	31.3	22	0.15
A-0806-MNPT	08	1/2	12.7	06	3/8-18	28.6	19	0.12
A-0808-MNPT	08	1/2	12.7	08	1/2-14	32.1	22	0.17
A-0812-MNPT	08	1/2	12.7	12	3/4-14	34.1	27	0.22
A-1008-MNPT	10	5/8	15.9	08	1/2-14	32.1	27	0.23
A-1012-MNPT	10	5/8	15.9	12	3/4-14	34.1	27	0.24
A-1208-MNPT	12	3/4	19.0	08	1/2-14	32.1	19	0.25
A-1212-MNPT	12	3/4	19.0	12	3/4-14	34.6	27	0.26
A-1216-MNPT	12	3/4	19.0	16	1-11 1/2	43.6	36	0.46
A-1416-MNPT	14	7/8	22.0	16	1-11 1/2	43.6	36	0.48
A-1612-MNPT	16	1	25.4	12	3/4-14	34.6	27	0.51
A-1616-MNPT	16	1	25.4	16	1-11 1/2	44.4	36	0.53
A-1620-MNPT	16	1	25.4	20	1 1/4-11 1/2	47.4	46	1.10
A-1820-MNPT	18	1 1/8	29.0	20	1 1/4-11 1/2	49.0	46	1.10
A-2020-MNPT	20	1 1/4	31.8	20	1 1/4-11 1/2	49.0	46	0.90
A-2224-MNPT	22	1 3/8	35.0	24	1 1/2-11 1/2	50.5	50	1.10
A-2424-MNPT	24	1 1/2	38.1	24	1 1/2-11 1/2	50.5	50	1.10
A-2932-MNPT	29	1 13/16	46.0	24	2-11 1/2	54.0	65	2.86
A-3232-MNPT	32	2	50.8	32	2-11 1/2	54.2	65	2.87

NOTE: Also available in stainless steel in some sizes. To order stainless, add -SS to the end of the part number.
Example: A-0606-XXXX-SS

Because we continually examine ways to improve our products, we reserve the right to alter specifications or discontinue products without prior notice.

HOSES
ONE-PIECE B SERIES
ONE-PIECE D SERIES
ONE-PIECE F & P SERIES
TWO-PIECE FERRULES (A & PFR SERIES)
TWO-PIECE INSERTS (A SERIES)
TWO-PIECE INTERLOCK FERRULES & INSERTS (X & Z SERIES)
QUICK RELEASE
ASSEMBLY EQUIPMENT
TECHNICAL INFORMATION

Inserts for two-piece fittings – US End Configurations

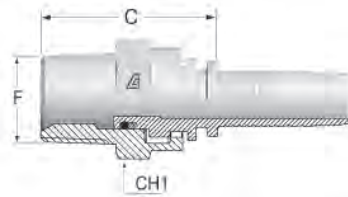

NPTF Male Swivel 60° Seat

Part Number	Dash Size	Hose ID Size		F Thread		C Cut-Off Factor (mm)	Hex Dia. CH1 (mm)	Weight (lbs/each)
		(in)	(mm)	Dash Size	Size (in) - TPI			
A-0404-MNPS	04	1/4	6.4	04	1/4-18	37.6	17	0.09
A-0406-MNPS	04	1/4	6.4	06	3/8-18	39.5	22	0.11
A-0604-MNPS	06	3/8	9.5	04	1/4-18	39.6	17	0.12
A-0606-MNPS	06	3/8	9.5	06	3/8-18	37.5	22	0.15
A-0608-MNPS	06	3/8	9.5	08	1/2-14	38.0	25	0.16
A-0806-MNPS	08	1/2	12.7	06	3/8-18	38.3	22	0.17
A-0808-MNPS	08	1/2	12.7	08	1/2-14	42.3	25	0.25
A-1212-MNPS	12	3/4	19.0	12	3/4-14	50.1	32	0.31
A-1616-MNPS	16	1	25.4	16	1-11 1/2	57.9	41	0.63

NOTE: Also available in stainless steel in some sizes. To order stainless, add -SS to the end of the part number.
Example: A-0606-XXXX-SS

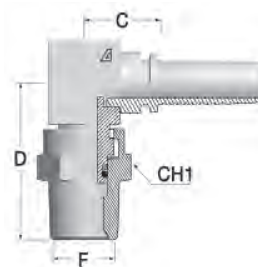

90° Compact NPTF Male Swivel 60° Seat

Part Number	Dash Size	Hose ID Size		F Thread		C Cut-Off Factor (mm)	D Drop (mm)	Hex Dia. CH1 (mm)	Weight (lbs/each)
		(in)	(mm)	Dash Size	Size (in) - TPI				
A-0404-MPS9	04	1/4	6.4	04	1/4-18	17	39	17	0.12
A-0406-MPS9	04	1/4	6.4	06	3/8-18	19	39	22	0.13
A-0604-MPS9	06	3/8	9.5	04	1/4-18	17	41	17	0.15
A-0606-MPS9	06	3/8	9.5	06	3/8-18	20	41	22	0.17
A-0608-MPS9	06	3/8	9.5	08	1/2-14	22	41	25	0.20
A-0806-MPS9	08	1/2	12.7	06	3/8-18	23	48	22	0.25
A-0808-MPS9	08	1/2	12.7	08	1/2-14	23	48	25	0.29
A-1212-MPS9	12	3/4	19.0	12	3/4-14	27	61	32	0.35
A-1616-MPS9	16	1	25.4	16	1-11 1/2	35	70	41	0.70

Because we continually examine ways to improve our products, we reserve the right to alter specifications or discontinue products without prior notice.

Two-Piece Fittings - A Series



Inserts for two-piece fittings – US End Configurations

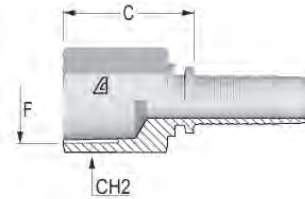

NPTF Female Rigid

Part Number	Dash Size	Hose ID Size		F Thread		C Cut-Off Factor (mm)	Hex Dia. CH2 (mm)	Weight (lbs/each)
		(in)	(mm)	Dash Size	Size (in) - TPI			
A-0404-FNPR	04	1/4	6.4	04	1/4-18	27.8	19	0.10
A-0606-FNPR	06	3/8	9.5	06	3/8-18	28.8	22	0.17
A-0808-FNPR	08	1/2	12.7	08	1/2-14	35.6	25	0.20
A-1212-FNPR	12	3/4	19.0	12	3/4-14	38.1	32	0.35
A-1616-FNPR	16	1	25.4	16	1-11 1/2	44.9	38	0.57

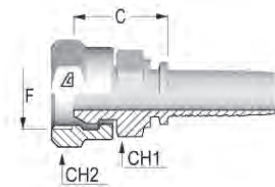

NPSM Female Swivel 60° Seat

Part Number	Dash Size	Hose ID Size		F Thread		C Cut-Off Factor (mm)	Hex Dia. CH1 (mm)	Hex Dia. CH2 (mm)	Weight (lbs/each)
		(in)	(mm)	Dash Size	Size (in) - TPI				
A-0404-FPMS	04	1/4	6.4	04	1/4-18	24.3	17	19	0.09
A-0606-FPMS	06	3/8	9.5	06	3/8-18	24.8	19	22	0.14
A-0808-FPMS	08	1/2	12.7	08	1/2-14	26.6	22	27	0.22
A-1012-FPMS	10	5/8	15.9	12	3/4-14	28.6	27	32	0.25
A-1212-FPMS	12	3/4	19.0	12	3/4-14	28.6	30	32	0.26
A-1616-FPMS	16	1	25.4	16	1-11 1/2	35.4	36	38	0.37

Because we continually examine ways to improve our products, we reserve the right to alter specifications or discontinue products without prior notice.

HOSES
ONE-PIECE B SERIES
ONE-PIECE D SERIES
ONE-PIECE F & P SERIES
TWO-PIECE FERRULES (A & PFR SERIES)
TWO-PIECE INSERTS (A SERIES)
TWO-PIECE INTERLOCK FERRULES & INSERTS (X & Z SERIES)
QUICK RELEASE
ASSEMBLY EQUIPMENT
TECHNICAL INFORMATION

Inserts for two-piece fittings – US End Configurations

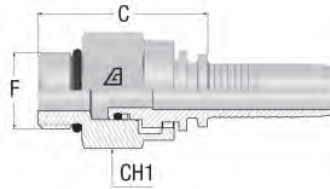

SAE Male O-Ring Boss Swivel

Part Number	Dash Size	Hose ID Size		F Thread		C Cut-Off Factor (mm)	Hex Dia. CH1 (mm)	Weight (lbs/each)
		(in)	(mm)	Dash Size	Size (in) - TPI			
A-0404-MOBS	04	1/4	6.4	04	7/16-20	17.0	17	0.13
A-0405-MOBS	04	1/4	6.4	05	1/2-20	17.0	17	0.14
A-0406-MOBS	04	1/4	6.4	06	9/16-18	17.5	19	0.15
A-0606-MOBS	06	3/8	9.5	06	9/16-18	20.5	22	0.16
A-0608-MOBS	06	3/8	9.5	08	3/4-16	22.0	22	0.18
A-0808-MOBS	08	1/2	12.7	08	3/4-16	23.0	25	0.19
A-0810-MOBS	08	1/2	12.7	10	7/8-14	23.0	25	0.27
A-1212-MOBS	12	3/4	19.0	12	1 1/16-12	49.6	32	0.33
A-1616-MOBS	16	1	25.4	16	1 5/16-12	54.1	38	0.65

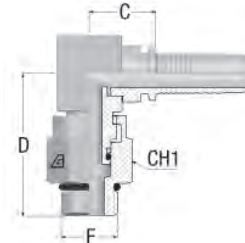

90° Compact SAE Male Swivel O-Ring Boss

Part Number	Dash Size	Hose ID Size		F Thread		C Cut-Off Factor (mm)	D Drop (mm)	Hex Dia. CH1 (mm)	Weight (lbs/each)
		(in)	(mm)	Dash Size	Size (in) - TPI				
A-0404-MBS9	04	1/4	6.4	04	7/16-20	17	34	17	0.14
A-0405-MBS9	04	1/4	6.4	05	1/2-20	17	34	17	0.17
A-0406-MBS9	04	1/4	6.4	06	9/16-18	18	36	19	0.18
A-0606-MBS9	06	3/8	9.5	06	9/16-18	19	40	22	0.18
A-0608-MBS9	06	3/8	9.5	08	3/4-16	22	44	25	0.19
A-0808-MBS9	08	1/2	12.7	08	3/4-16	23	47	25	0.22
A-0810-MBS9	08	1/2	12.7	10	7/8-14	23	49	25	0.26
A-1012-MBS9	10	5/8	15.9	12	1 1/16-12	27	60	32	0.33
A-1212-MBS9	12	3/4	19.0	12	1 1/16-12	27	61	32	0.37
A-1616-MBS9	16	1	25.4	16	1 5/16-12	34	66	38	0.70

Because we continually examine ways to improve our products, we reserve the right to alter specifications or discontinue products without prior notice.

Two-Piece Fittings - A Series



Inserts for two-piece fittings – US End Configurations

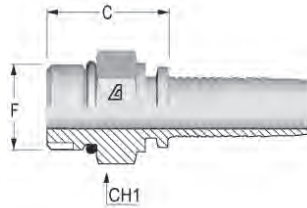

SAE Male O-Ring Boss

Part Number	Dash Size	Hose ID Size		F Thread		C Cut-Off Factor (mm)	Hex Dia. CH1 (mm)	Weight (lbs/each)
		(in)	(mm)	Dash Size	Size (in) - TPI			
A-0404-MORB	04	1/4	6.4	04	7/16-20	20.3	14	0.04
A-0405-MORB	04	1/4	6.4	05	1/2-20	21.3	16	0.05
A-0406-MORB	04	1/4	6.4	06	9/16-18	22.3	17	0.06
A-0606-MORB	06	3/8	9.5	06	9/16-18	23.3	19	0.08
A-0608-MORB	06	3/8	9.5	08	3/4-16	24.3	22	0.12
A-0610-MORB	06	3/8	9.5	10	7/8-14	26.8	27	0.16
A-0808-MORB	08	1/2	12.7	08	3/4-16	25.1	22	0.14
A-0810-MORB	08	1/2	12.7	10	7/8-14	27.6	27	0.19
A-0812-MORB	08	1/2	12.7	12	1 1/16-12	32.1	32	0.28
A-1008-MORB	10	5/8	15.8	08	3/4-16	27.6	22	0.23
A-1010-MORB	10	5/8	15.8	10	7/8-14	27.6	24	0.25
A-1012-MORB	10	5/8	15.8	12	1 1/16-12	32.1	32	0.27
A-1210-MORB	12	3/4	19.0	10	7/8-14	28.1	27	0.24
A-1212-MORB	12	3/4	19.0	12	1 1/16-12	32.6	32	0.31
A-1216-MORB	12	3/4	19.0	16	1 5/16-12	35.7	38	0.44
A-1616-MORB	16	1	25.4	16	1 5/16-12	35.4	38	0.55

Because we continually examine ways to improve our products, we reserve the right to alter specifications or discontinue products without prior notice.



HOSES
ONE-PIECE B SERIES
ONE-PIECE D SERIES
ONE-PIECE F & P SERIES
TWO-PIECE FERRULES (A & PFR SERIES)
TWO-PIECE INSERTS (A SERIES)
TWO-PIECE INTERLOCK FERRULES & INSERTS (X & Z SERIES)
QUICK RELEASE
ASSEMBLY EQUIPMENT
TECHNICAL INFORMATION

Inserts for two-piece fittings – US End Configurations

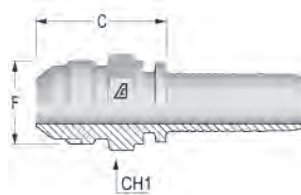

JIC Male 37° Seat

Part Number	Dash Size	Hose ID Size		F Thread		C Cut-Off Factor (mm)	Hex Dia. CH1 (mm)	Weight (lbs/each)
		(in)	(mm)	Dash Size	Size (in) - TPI			
A-0304-MJIC	03	3/16	4.8	04	7/16-20	23.4	12	0.03
A-0404-MJIC	04	1/4	6.4	04	7/16-20	25.3	12	0.04
A-0405-MJIC	04	1/4	6.4	05	1/2-20	25.3	14	0.05
A-0406-MJIC	04	1/4	6.4	06	9/16-18	26.3	17	0.06
A-0505-MJIC	05	5/16	7.9	05	1/2-20	25.3	14	0.05
A-0506-MJIC	05	5/16	7.9	06	9/16-18	26.3	17	0.07
A-0605-MJIC	06	3/8	9.5	05	1/2-20	26.3	17	0.07
A-0606-MJIC	06	3/8	9.5	06	9/16-18	26.3	17	0.07
A-0608-MJIC	06	3/8	9.5	08	3/4-16	29.8	19	0.11
A-0808-MJIC	08	1/2	12.7	08	3/4-16	29.8	19	0.12
A-0810-MJIC	08	1/2	12.7	10	7/8-14	34.6	24	0.19
A-0812-MJIC	08	1/2	12.7	12	1 1/16-12	37.1	27	0.23
A-1010-MJIC	10	5/8	15.9	10	7/8-14	34.6	24	0.18
A-1012-MJIC	10	5/8	15.9	12	1 1/16-12	37.1	27	0.23
A-1212-MJIC	12	3/4	19.0	12	1 1/16-12	37.6	27	0.27
A-1214-MJIC	12	3/4	19.0	14	1 3/16-12	40.1	32	0.36
A-1216-MJIC	12	3/4	19.0	16	1 5/16-12	42.6	36	0.54
A-1616-MJIC	16	1	25.4	16	1 5/16-12	43.4	36	0.51
A-1620-MJIC	16	1	25.4	20	1 5/8-12	46.9	46	0.77
A-2020-MJIC	20	1 1/4	31.8	20	1 5/8-12	48.5	46	0.89
A-2024-MJIC	20	1 1/4	31.8	24	1 7/8-12	52.5	50	1.13
A-2424-MJIC	24	1 1/2	38.1	24	1 7/8-12	52.5	50	1.29
A-3232-MJIC	32	2	50.8	32	2 1/2-12	52.0	65	3.97

Because we continually examine ways to improve our products, we reserve the right to alter specifications or discontinue products without prior notice.

Two-Piece Fittings - A Series



Inserts for two-piece fittings – US End Configurations

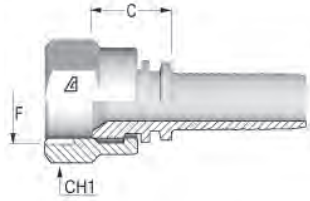

JIC Female 37° Seat

Part Number	Dash Size	Hose ID Size		F Thread		C Cut-Off Factor (mm)	Hex Dia. CH1 (mm)	Weight (lbs/each)
		(in)	(mm)	Dash Size	Size (in) - TPI			
A-0304-FJSH	03	3/16	4.8	04	7/16-20	14.3	16	0.04
A-0404-FJSH	04	1/4	6.4	04	7/16-20	14.6	16	0.04
A-0405-FJSH	04	1/4	6.4	05	1/2-20	15.3	17	0.06
A-0406-FJSH	04	1/4	6.4	06	9/16-18	15.3	19	0.07
A-0505-FJSH	05	5/16	7.9	05	1/2-20	15.3	17	0.07
A-0506-FJSH	05	5/16	7.9	06	9/16-18	15.3	19	0.08
A-0606-FJSH	06	3/8	9.5	06	9/16-18	15.3	19	0.08
A-0608-FJSH	06	3/8	9.5	08	3/4-16	17.8	25	0.14
A-0808-FJSH	08	1/2	12.7	08	3/4-16	18.6	25	0.16
A-0810-FJSH	08	1/2	12.7	10	7/8-14	19.6	27	0.19
A-0812-FJSH	08	1/2	12.7	12	1 1/16-12	22.1	32	0.25
A-1010-FJSH	10	5/8	15.9	10	7/8-14	19.6	27	0.21
A-1012-FJSH	10	5/8	15.9	12	1 1/16-12	20.1	32	0.26
A-1210-FJSH	12	3/4	19.0	10	7/8-14	20.0	27	0.28
A-1212-FJSH	12	3/4	19.0	12	1 1/16-12	20.0	32	0.28
A-1214-FJSH	12	3/4	19.0	14	1 3/16-12	20.0	36	0.33
A-1216-FJSH	12	3/4	19.0	16	1 5/16-12	22.1	38	0.38
A-1616-FJSH	16	1	25.4	16	1 5/16-12	23.9	38	0.46
A-1620-FJSH	16	1	25.4	20	1 5/8-12	26.5	50	0.88
A-2020-FJSH	20	1 1/4	31.8	20	1 5/8-12	28.1	50	0.96
A-2024-FJSH	20	1 1/4	31.8	24	1 7/8-12	30.4	55	1.18
A-2424-FJSH	24	1 1/2	38.1	24	1 7/8-12	31.4	55	1.24
A-3232-FJSH	32	2	50.8	32	2 1/2-12	32.0	70	2.19

Because we continually examine ways to improve our products, we reserve the right to alter specifications or discontinue products without prior notice.



HOSES
ONE-PIECE B SERIES
ONE-PIECE D SERIES
ONE-PIECE F & P SERIES
TWO-PIECE FERRULES (A & PFR SERIES)
TWO-PIECE INSERTS (A SERIES)
TWO-PIECE INTERLOCK FERRULES & INSERTS (X & Z SERIES)
QUICK RELEASE
ASSEMBLY EQUIPMENT
TECHNICAL INFORMATION

Inserts for two-piece fittings – US End Configurations

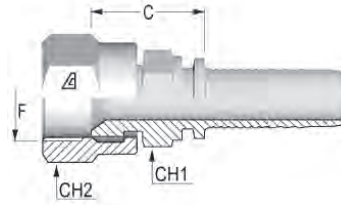

JIC Female 37° Seat – Double Hex

Part Number	Dash Size	Hose ID Size		F Thread		C Cut-Off Factor (mm)	Hex Dia. CH1 (mm)	Hex Dia. CH2 (mm)	Weight (lbs/each)
		(in)	(mm)	Dash Size	Size (in) - TPI				
A-0304-FJDH	03	3/16	4.8	04	7/16-20	18.1	12	16	0.05
A-0404-FJDH	04	1/4	6.4	04	7/16-20	19.6	14	16	0.06
A-0405-FJDH	04	1/4	6.4	05	1/2-20	20.3	14	17	0.07
A-0406-FJDH	04	1/4	6.4	06	9/16-18	20.3	14	19	0.09
A-0506-FJDH	05	5/16	7.9	06	9/16-18	20.3	14	19	0.08
A-0604-FJDH	06	3/8	9.5	04	7/16-20	20.6	17	16	0.08
A-0605-FJDH	06	3/8	9.5	05	1/2-20	21.3	16	17	0.90
A-0606-FJDH	06	3/8	9.5	06	9/16-18	21.3	17	19	0.10
A-0608-FJDH	06	3/8	9.5	08	3/4-16	24.8	19	25	0.17
A-0610-FJDH	06	3/8	9.5	10	7/8-14	25.8	22	27	0.20
A-0806-FJDH	08	1/2	12.7	06	9/16-18	23.1	19	19	0.15
A-0808-FJDH	08	1/2	12.7	08	3/4-16	25.6	19	25	0.20
A-0810-FJDH	08	1/2	12.7	10	7/8-14	26.6	22	27	0.22
A-0812-FJDH	08	1/2	12.7	12	1 1/16-12	28.1	25	32	0.30
A-1008-FJDH	10	5/8	15.9	08	3/4-16	26.6	24	25	0.30
A-1010-FJDH	10	5/8	15.9	10	7/8-14	27.6	24	27	0.27
A-1012-FJDH	10	5/8	15.9	12	1 1/16-12	28.1	25	32	0.32
A-1210-FJDH	12	3/4	19.0	10	7/8-14	28.1	27	32	0.31
A-1212-FJDH	12	3/4	19.0	12	1 1/16-12	28.6	27	32	0.35
A-1214-FJDH	12	3/4	19.0	14	1 3/16-12	29.9	32	36	0.44
A-1216-FJDH	12	3/4	19.0	16	1 5/16-12	32.1	32	38	0.49
A-1416-FJDH	14	7/8	22.2	16	1 5/16-12	32.1	32	38	0.46
A-1612-FJDH	16	1	25.4	12	1 1/16-12	31.4	32	32	0.55
A-1616-FJDH	16	1	25.4	16	1 5/16-12	32.9	32	38	0.62
A-1820-FJDH	18	1 1/8	29.0	20	1 5/8-12	37.5	41	50	0.63
A-2020-FJDH	20	1 1/4	31.8	20	1 5/8-12	39.1	41	50	0.77
A-2224-FJDH	22	1 3/8	35.0	24	1 7/8-12	43.4	50	55	0.79
A-2424-FJDH	24	1 1/2	38.1	24	1 7/8-12	43.4	50	55	1.98
A-2932-FJDH	29	1 13/16	46.0	32	2 1/2-12	49.0	65	70	2.31
A-3232-FJDH	32	2	50.8	32	2 1/2-12	49.0	65	70	3.09

NOTE: Also available in stainless steel in some sizes. To order stainless, add -SS to the end of the part number.
Example: A-0606-XXXX-SS

Because we continually examine ways to improve our products, we reserve the right to alter specifications or discontinue products without prior notice.

Two-Piece Fittings - A Series

Inserts for two-piece fittings – US End Configurations

NEW

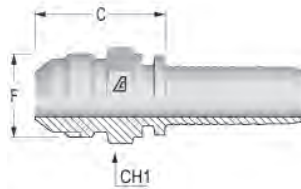

SAE 45° Male

Part Number	Dash Size	Hose ID Size		F Thread		C Cut-Off Factor (mm)	Hex Dia. CH1 (mm)	Hex Dia. CH2 (mm)	Weight (lbs/each)
		(in)	(mm)	Dash Size	Size (in) - TPI				
A-0506-MSAE	5	5/16	7.9	6	5/8-18	28	16	n/a	0.08
A-0606-MSAE	6	3/8	9.5	6	5/8-18	28	16	n/a	0.08
A-1012-MSAE	10	5/8	15.9	12	1 1/16-14	43.5	27	n/a	0.31
A-1212-MSAE	12	3/4	19.0	12	1 1/16-14	41	27	n/a	0.32

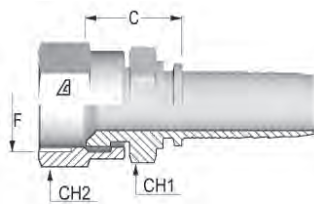

SAE Female 45° Seat – Double Hex

Part Number	Dash Size	Hose ID Size		F Thread		C Cut-Off Factor (mm)	Hex Dia. CH1 (mm)	Hex Dia. CH2 (mm)	Weight (lbs/each)
		(in)	(mm)	Dash Size	Size (in) - TPI				
A-0506-FSAE	5	5/16	7.9	6	5/8-18	22.3	16	22	0.13
A-0606-FSAE	6	3/8	9.5	6	5/8-18	22.3	19	22	0.31
A-1012-FSAE	10	5/8	15.9	12	1 1/16-14	28.1	27	32	0.34
A-1212-FSAE	12	3/4	19.0	12	1 1/16-14	29.6	27	32	0.77

Because we continually examine ways to improve our products, we reserve the right to alter specifications or discontinue products without prior notice.

HOSES
ONE-PIECE B SERIES
ONE-PIECE D SERIES
ONE-PIECE F & P SERIES
TWO-PIECE FERRULES (A & PFR SERIES)
TWO-PIECE INSERTS (A SERIES)
TWO-PIECE INTERLOCK FERRULES & INSERTS (X & Z SERIES)
QUICK RELEASE
ASSEMBLY EQUIPMENT
TECHNICAL INFORMATION

Inserts for two-piece fittings – US End Configurations

NEW

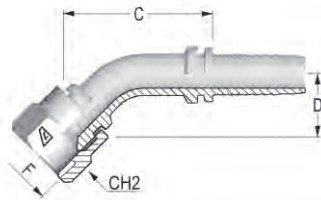

45° Female SAE 45°

Part Number	Dash Size	Hose ID Size		F Thread		C Cut-Off Factor (mm)	Hex Dia. CH1 (mm)	Hex Dia. CH2 (mm)	Weight (lbs/each)
		(in)	(mm)	Dash Size	Size (in) - TPI				
A-0506-FAE4	5	5/16	7.9	6	5/8-18	43	12	22	0.13
A-0606-FAE4	6	3/8	9.5	6	5/8-18	46	12	22	0.14
A-1012-FAE4	10	5/8	15.9	12	1 1/16-14	69	21	32	0.45
A-1212-FAE4	12	3/4	19.0	12	1 1/16-14	68	21	32	0.48

NEW

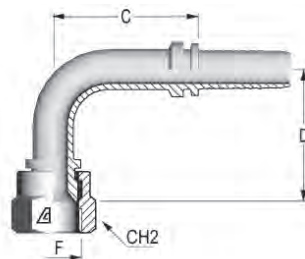

90° Female SAE 45°

Part Number	Dash Size	Hose ID Size		F Thread		C Cut-Off Factor (mm)	Hex Dia. CH1 (mm)	Hex Dia. CH2 (mm)	Weight (lbs/each)
		(in)	(mm)	Dash Size	Size (in) - TPI				
A-0506-FAE9	5	5/16	7.9	6	5/8-18	31.5	35	22	0.17
A-0606-FAE9	6	3/8	9.5	6	5/8-18	42.5	24	22	0.18
A-1012-FAE9	10	5/8	15.9	12	1 1/16-14	48	58	32	0.48
A-1212-FAE9	12	3/4	19.0	12	1 1/16-14	48.5	58	32	0.55

Because we continually examine ways to improve our products, we reserve the right to alter specifications or discontinue products without prior notice.

Two-Piece Fittings - A Series



HOSES
ONE-PIECE B SERIES
ONE-PIECE D SERIES
ONE-PIECE F & P SERIES
TWO-PIECE FERRULES (A & PFR SERIES)
TWO-PIECE INSERTS (A SERIES)
TWO-PIECE INTERLOCK FERRULES & INSERTS (X & Z SERIES)
QUICK RELEASE
ASSEMBLY EQUIPMENT

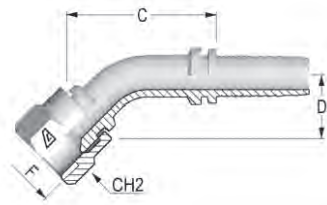

45° JIC Female Swivel 37° Seat

Part Number	Dash Size	Hose ID Size		F Thread		C Cut-Off Factor (mm)	D Drop (mm)	Hex Dia. CH2 (mm)	Weight (lbs/each)
		(in)	(mm)	Dash Size	Size (in) - TPI				
A-0404-FJ45	04	1/4	6.4	04	7/16-20	36.6	10.0	16	0.08
A-0405-FJ45	04	1/4	6.4	05	1/2-20	37.2	12.0	17	0.08
A-0406-FJ45	04	1/4	6.4	06	9/16-18	39.4	11.0	19	0.10
A-0506-FJ45	05	5/16	7.9	06	9/16-18	42.8	12.0	19	0.13
A-0606-FJ45	06	3/8	9.5	06	9/16-18	46.3	11.0	19	0.13
A-0608-FJ45	06	3/8	9.5	08	3/4-16	47.2	15.0	25	0.19
A-0808-FJ45	08	1/2	12.7	08	3/4-16	51.6	15.0	25	0.23
A-0810-FJ45	08	1/2	12.7	10	7/8-14	50.7	16.0	27	0.27
A-0812-FJ45	08	1/2	12.7	12	1 1/16-12	57.0	21.0	32	0.39
A-1010-FJ45	10	5/8	15.9	10	7/8-14	62.2	19.0	27	0.39
A-1012-FJ45	10	5/8	15.9	12	1 1/16-12	68.6	21.0	32	0.39
A-1212-FJ45	12	3/4	19.0	12	1 1/16-12	67.5	21.0	32	0.62
A-1214-FJ45	12	3/4	19.0	14	1 3/16-12	67.6	23.0	36	0.51
A-1216-FJ45	12	3/4	19.0	16	1 5/16-12	71.4	26.0	38	0.62
A-1616-FJ45	16	1	25.4	16	1 5/16-12	79.5	24.0	38	0.88
A-1620-FJ45	16	1	25.4	20	1 5/8-12	81.9	37.0	50	1.28
A-2020-FJ45	20	1 1/4	31.8	20	1 5/8-12	97.1	37.0	50	1.56
A-2024-FJ45	20	1 1/4	31.8	24	1 7/8-12	107.0	39.5	55	1.74
A-2424-FJ45	24	1 1/2	38.1	24	1 7/8-12	112.7	43.0	55	2.09
A-3232-FJ45	32	2	50.8	32	2 1/2-12	159.9	67.0	70	2.21

Because we continually examine ways to improve our products, we reserve the right to alter specifications or discontinue products without prior notice.



TECHNICAL INFORMATION

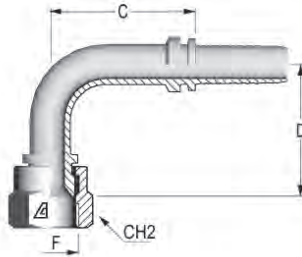

90° JIC Female Swivel 37° Seat Short Drop

Part Number	Dash Size	Hose ID Size		F Thread		C Cut-Off Factor (mm)	D Drop (mm)	Hex Dia. CH2 (mm)	Weight (lbs/each)
		(in)	(mm)	Dash Size	Size (in) - TPI				
A-0304-FJ9S	03	3/16	4.8	04	7/16-20	26.7	21.0	16	0.08
A-0404-FJ9S	04	1/4	6.4	04	7/16-20	27.0	21.0	16	0.08
A-0405-FJ9S	04	1/4	6.4	05	1/2-20	26.5	23.5	17	0.10
A-0406-FJ9S	04	1/4	6.4	06	9/16-18	31.0	23.0	19	0.10
A-0506-FJ9S	05	5/16	7.9	06	9/16-18	42.7	23.0	19	0.12
A-0606-FJ9S	06	3/8	9.5	06	9/16-18	42.3	23.0	19	0.13
A-0608-FJ9S	06	3/8	9.5	08	3/4-16	48.8	29.0	25	0.20
A-0808-FJ9S	08	1/2	12.7	08	3/4-16	46.4	29.0	25	0.25
A-0810-FJ9S	08	1/2	12.7	10	7/8-14	45.8	32.0	27	0.28
A-0812-FJ9S	08	1/2	12.7	12	1 1/16-12	37.3	46.0	32	0.38
A-1010-FJ9S	10	5/8	15.9	10	7/8-14	36.5	32.0	27	0.41
A-1012-FJ9S	10	5/8	15.9	12	1 1/16-12	47.9	48.0	32	0.46
A-1212-FJ9S	12	3/4	19.0	12	1 1/16-12	58.2	46.0	32	0.63
A-1214-FJ9S	12	3/4	19.0	14	1 3/16-12	52.4	47.0	36	0.64
A-1216-FJ9S	12	3/4	19.0	16	1 5/16-12	53.6	53.0	38	0.73
A-1416-FJ9S	14	7/8	22.2	16	1 5/16-12	53.6	53.0	38	0.77
A-1616-FJ9S	16	1	25.4	16	1 5/16-12	70.9	56.0	38	0.89
A-2020-FJ9S	20	1 1/4	31.8	20	1 5/8-12	82.0	68.0	50	1.20

Because we continually examine ways to improve our products, we reserve the right to alter specifications or discontinue products without prior notice.

Two-Piece Fittings - A Series



Inserts for two-piece fittings – US End Configurations

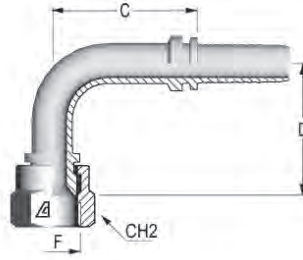

90° JIC Female Swivel 37° Seat Medium Drop

Part Number	Dash Size	Hose ID Size		F Thread		C Cut-Off Factor (mm)	D Drop (mm)	Hex Dia. CH2 (mm)	Weight (lbs/each)
		(in)	(mm)	Dash Size	Size (in) - TPI				
A-0304-FJ9M	03	3/16	4.8	04	7/16-20	33.5	32.0	16	0.10
A-0404-FJ9M	04	1/4	6.4	04	7/16-20	34.2	32.0	16	0.10
A-0405-FJ9M	04	1/4	6.4	05	1/2-20	25.7	30.0	17	0.09
A-0406-FJ9M	04	1/4	6.4	06	9/16-18	28.5	38.0	19	0.11
A-0505-FJ9M	05	5/16	7.9	05	1/2-20	34.7	35.0	17	0.14
A-0506-FJ9M	05	5/16	7.9	06	9/16-18	33.2	35.0	19	0.14
A-0606-FJ9M	06	3/8	9.5	06	9/16-18	31.3	35.0	19	0.15
A-0608-FJ9M	06	3/8	9.5	08	3/4-16	39.5	41.0	25	0.22
A-0808-FJ9M	08	1/2	12.7	08	3/4-16	37.2	40.0	25	0.26
A-0810-FJ9M	08	1/2	12.7	10	7/8-14	43.3	47.0	27	0.30
A-0812-FJ9M	08	1/2	12.7	12	1 1/16-12	47.8	58.0	32	0.40
A-1010-FJ9M	10	5/8	15.9	10	7/8-14	49.4	48.0	27	0.40
A-1012-FJ9M	10	5/8	15.9	12	1 1/16-12	47.9	58.0	32	0.48
A-1212-FJ9M	12	3/4	19.0	12	1 1/16-12	52.4	54.0	32	0.68
A-1214-FJ9M	12	3/4	19.0	14	1 3/16-12	53.5	47.5	36	0.71
A-1216-FJ9M	12	3/4	19.0	16	1 5/16-12	52.6	72.0	38	0.79
A-1616-FJ9M	16	1	25.4	16	1 5/16-12	72.6	71.5	38	1.01
A-1620-FJ9M	16	1	25.4	20	1 5/8-12	72.6	78.5	50	1.48
A-2020-FJ9M	20	1 1/4	31.8	20	1 5/8-12	82.4	78.0	50	1.68
A-2024-FJ9M	20	1 1/4	31.8	24	1 7/8-12	94.0	82.0	55	2.00
A-2424-FJ9M	24	1 1/2	38.1	24	1 7/8-12	95.3	92.0	55	2.38
A-3232-FJ9M	32	2	50.8	32	2 1/2-12	129.5	140.0	70	5.24

Because we continually examine ways to improve our products, we reserve the right to alter specifications or discontinue products without prior notice.



HOSES
ONE-PIECE B SERIES
ONE-PIECE D SERIES
ONE-PIECE F & P SERIES
TWO-PIECE FERRULES (A & PFR SERIES)
TWO-PIECE INSERTS (A SERIES)
TWO-PIECE INTERLOCK FERRULES & INSERTS (X & Z SERIES)
QUICK RELEASE
ASSEMBLY EQUIPMENT
TECHNICAL INFORMATION

Inserts for two-piece fittings – US End Configurations

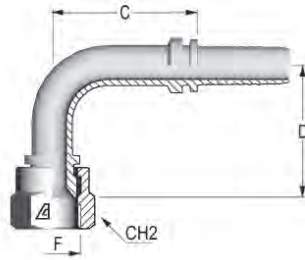

90° JIC Female Swivel 37° Seat Long Drop

Part Number	Dash Size	Hose ID Size		F Thread		C Cut-Off Factor (mm)	D Drop (mm)	Hex Dia. CH2 (mm)	Weight (lbs/each)
		(in)	(mm)	Dash Size	Size (in) - TPI				
A-0304-FJ9L	03	3/16	4.8	04	7/16-20	25.5	46	16	0.12
A-0404-FJ9L	04	1/4	6.4	04	7/16-20	30.8	46	16	0.11
A-0405-FJ9L	04	1/4	6.4	05	1/2-20	31.3	45	17	0.13
A-0406-FJ9L	04	1/4	6.4	06	9/16-18	34.3	54	19	0.17
A-0506-FJ9L	05	5/16	7.9	06	9/16-18	36.2	54	19	0.18
A-0606-FJ9L	06	3/8	9.5	06	9/16-18	43.3	54	19	0.19
A-0608-FJ9L	06	3/8	9.5	08	3/4-16	46.8	64	25	0.24
A-0808-FJ9L	08	1/2	12.7	08	3/4-16	49.9	64	25	0.31
A-0810-FJ9L	08	1/2	12.7	10	7/8-14	37.3	65	27	0.33
A-1010-FJ9L	10	5/8	15.9	10	7/8-14	49.9	65	27	0.44
A-1012-FJ9L	10	5/8	15.9	12	1 1/16-12	49.9	96	32	0.58
A-1212-FJ9L	12	3/4	19.0	12	1 1/16-12	54.1	95	32	0.76
A-1216-FJ9L	12	3/4	19.0	16	1 5/16-12	54.0	114	38	0.93
A-1616-FJ9L	16	1	25.4	16	1 5/16-12	78.6	114	38	1.33

Because we continually examine ways to improve our products, we reserve the right to alter specifications or discontinue products without prior notice.

Two-Piece Fittings - A Series



Inserts for two-piece fittings – US End Configurations

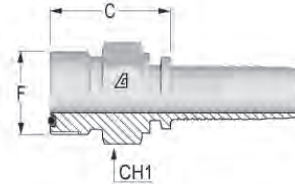

ORFS Male

Part Number	Dash Size	Hose ID Size		F Thread		C Cut-Off Factor (mm)	Hex Dia. CH1 (mm)	Weight (lbs/each)
		(in)	(mm)	Dash Size	Size (in) - TPI			
A-0404-MOFS	04	1/4	6.4	04	9/16-18	22.3	17	0.07
A-0406-MOFS	04	1/4	6.4	06	11/16-16	24.3	19	0.09
A-0606-MOFS	06	3/8	9.5	06	11/16-16	24.3	19	0.11
A-0608-MOFS	06	3/8	9.5	08	13/16-16	26.3	22	0.13
A-0610-MOFS	06	3/8	9.5	10	1-14	29.8	27	0.19
A-0808-MOFS	08	1/2	12.7	08	1 3/16-16	27.1	22	0.17
A-0810-MOFS	08	1/2	12.7	10	1-14	30.6	27	0.22
A-0812-MOFS	08	1/2	12.7	12	1 3/16-12	34.1	32	0.24
A-1010-MOFS	10	5/8	15.9	10	1-14	30.6	27	0.23
A-1012-MOFS	10	5/8	15.9	12	1 3/16-12	34.1	32	0.30
A-1210-MOFS	12	3/4	19.0	10	1-14	31.1	27	0.28
A-1212-MOFS	12	3/4	19.0	12	1 3/16-12	34.6	32	0.40
A-1216-MOFS	12	3/4	19.0	16	1 7/16-12	38.1	41	0.58
A-1616-MOFS	16	1	25.4	16	1 7/16-12	37.9	38	0.60
A-1620-MOFS	16	1	25.4	20	1 11/16-12	39.9	46	0.78
A-2020-MOFS	20	1 1/4	31.8	20	1 11/16-12	41.5	46	0.90

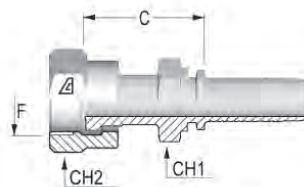

ORFS Female – Double Hex

Part Number	Dash Size	Hose ID Size		F Thread		C Cut-Off Factor (mm)	Hex Dia. CH1 (mm)	Hex Dia. CH2 (mm)	Weight (lbs/each)
		(in)	(mm)	Dash Size	Size (in) - TPI				
A-0404-FOFS	04	1/4	6.4	04	9/16-18	27.3	14	17	0.08
A-0406-FOFS	04	1/4	6.4	06	11/16-16	30.3	17	22	0.13
A-0506-FOFS	05	5/16	7.9	06	11/16-16	30.3	17	22	0.13
A-0606-FOFS	06	3/8	9.5	06	11/16-16	30.3	17	22	0.14
A-0608-FOFS	06	3/8	9.5	08	13/16-16	35.3	22	24	0.21
A-0806-FOFS	08	1/2	12.7	06	11/16-16	32.1	19	22	0.22
A-0808-FOFS	08	1/2	12.7	08	13/16-16	36.1	22	24	0.22

continued on the next page

Because we continually examine ways to improve our products, we reserve the right to alter specifications or discontinue products without prior notice.



HOSES
ONE-PIECE B SERIES
ONE-PIECE D SERIES
ONE-PIECE F & P SERIES
TWO-PIECE FERRULES (A & PFR SERIES)
TWO-PIECE INSERTS (A SERIES)
TWO-PIECE INTERLOCK FERRULES & INSERTS (X & Z SERIES)
QUICK RELEASE
ASSEMBLY EQUIPMENT
TECHNICAL INFORMATION

Inserts for two-piece fittings – US End Configurations

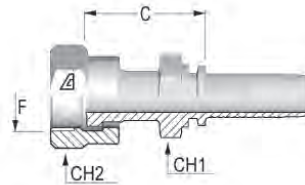

(continued)

ORFS Female – Double Hex

Part Number	Dash Size	Hose ID Size		F Thread		C Cut-Off Factor (mm)	Hex Dia. CH1 (mm)	Hex Dia. CH2 (mm)	Weight (lbs/each)
		(in)	(mm)	Dash Size	Size (in) - TPI				
A-0810-FOFS	08	1/2	12.7	10	1-14	39.6	24	30	0.32
A-0812-FOFS	08	1/2	12.7	12	1 3/16-12	42.1	30	36	0.32
A-1008-FOFS	10	5/8	15.9	08	13/16-16	39.6	24	24	0.31
A-1010-FOFS	10	5/8	15.9	10	1-14	39.6	24	30	0.32
A-1012-FOFS	10	5/8	15.9	12	1 3/16-12	42.1	30	36	0.50
A-1210-FOFS	12	3/4	19.0	10	1-14	40.1	27	30	0.50
A-1212-FOFS	12	3/4	19.0	12	1 3/16-12	42.6	30	36	0.50
A-1216-FOFS	12	3/4	19.0	16	1 7/16-12	48.6	36	41	0.73
A-1612-FOFS	16	1	25.4	12	1 3/16-12	45.4	32	36	0.73
A-1616-FOFS	16	1	25.4	16	1 7/16-12	49.4	36	41	0.73
A-1620-FOFS	16	1	25.4	20	1 11/16-12	50.4	41	50	0.79
A-2020-FOFS	20	1 1/4	31.8	20	1 11/16-12	52.0	41	50	1.10
A-2424-FOFS	24	1 1/2	38.1	24	2-12	56.5	50	60	1.76

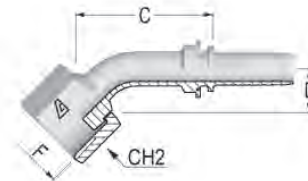

45° ORFS Female Swivel

Part Number	Dash Size	Hose ID Size		F Thread		C Cut-Off Factor (mm)	D Drop (mm)	Hex Dia. CH2 (mm)	Weight (lbs/each)
		(in)	(mm)	Dash Size	Size (in) - TPI				
A-0404-F045	04	1/4	6.4	04	9/16-18	41.1	11.0	17	0.08
A-0406-F045	04	1/4	6.4	06	11/16-16	46.1	11.0	22	0.12
A-0606-F045	06	3/8	9.5	06	11/16-16	47.4	12.0	22	0.14
A-0608-F045	06	3/8	9.5	08	13/16-16	51.2	15.0	24	0.19
A-0808-F045	08	1/2	12.7	08	13/16-16	47.1	16.0	24	0.29
A-0810-F045	08	1/2	12.7	10	1-14	50.4	16.5	30	0.29
A-0812-F045	08	1/2	12.7	12	1 3/16-12	53.1	16.5	36	0.31
A-1010-F045	10	5/8	15.9	10	1-14	57.7	17.0	30	0.33
A-1012-F045	10	5/8	15.9	12	1 3/16-12	60.1	17.0	36	0.38
A-1212-F045	12	3/4	19.0	12	1 3/16-12	63.5	21.0	36	0.60
A-1216-F045	12	3/4	19.0	16	1 7/16-12	70.7	24.0	41	1.01
A-1616-F045	16	1	25.4	16	1 7/16-12	82.4	26.0	41	0.90
A-2020-F045	20	1 1/4	31.8	20	1 11/16-12	97.4	26.0	50	1.25
A-2424-F045	24	1 1/2	38.1	24	2-12	105.5	28.0	60	1.68

Because we continually examine ways to improve our products, we reserve the right to alter specifications or discontinue products without prior notice.

Two-Piece Fittings - A Series



Inserts for two-piece fittings – US End Configurations

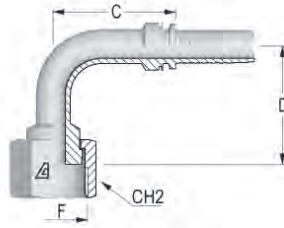

90° ORFS Female Swivel Short Drop

Part Number	Dash Size	Hose ID Size		F Thread		C Cut-Off Factor (mm)	D Drop (mm)	Hex Dia. CH2 (mm)	Weight (lbs/each)
		(in)	(mm)	Dash Size	Size (in) - TPI				
A-0404-F09S	04	1/4	6.4	04	9/16-18	28.5	21.0	17	0.08
A-0406-F09S	04	1/4	6.4	06	11/16-16	32.0	23.0	22	0.13
A-0506-F09S	05	5/16	7.9	06	11/16-16	48.7	26.0	22	0.15
A-0606-F09S	06	3/8	9.5	06	11/16-16	41.8	25.0	22	0.15
A-0608-F09S	06	3/8	9.5	08	13/16-16	41.8	29.0	24	0.19
A-0808-F09S	08	1/2	12.7	08	13/16-16	39.8	29.0	24	0.23
A-0810-F09S	08	1/2	12.7	10	1-14	46.3	32.5	30	0.31
A-0812-F09S	08	1/2	12.7	12	1 3/16-12	56.3	51.0	36	0.37
A-1010-F09S	10	5/8	15.9	10	1-14	52.3	32.5	30	0.37
A-1012-F09S	10	5/8	15.9	12	1 3/16-12	55.4	49.0	36	0.39
A-1212-F09S	12	3/4	19.0	12	1 3/16-12	60.6	51.0	36	0.66
A-1216-F09S	12	3/4	19.0	16	1 7/16-12	61.6	56.0	41	0.84
A-1612-F09S	16	1	25.4	12	1 3/16-12	82.6	58.0	41	0.96
A-1616-F09S	16	1	25.4	16	1 7/16-12	82.6	58.0	41	1.03
A-1620-F09S	16	1	25.4	20	1 11/16-12	82.6	64.0	50	1.48
A-2020-F09S	20	1 1/4	31.8	20	1 11/16-12	95.0	68.0	50	1.57
A-2424-F09S	24	1 1/2	38.1	24	2-12	101.6	78.0	60	2.18

Because we continually examine ways to improve our products, we reserve the right to alter specifications or discontinue products without prior notice.

HOSES
ONE-PIECE B SERIES
ONE-PIECE D SERIES
ONE-PIECE F & P SERIES
TWO-PIECE FERRULES (A & PFR SERIES)
TWO-PIECE INSERTS (A SERIES)
TWO-PIECE INTERLOCK FERRULES & INSERTS (X & Z SERIES)
QUICK RELEASE
ASSEMBLY EQUIPMENT
TECHNICAL INFORMATION

Inserts for two-piece fittings – US End Configurations

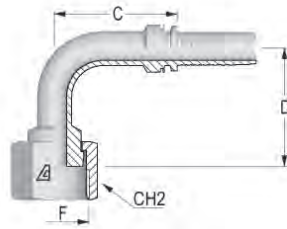

90° ORFS Female Swivel Medium Drop

Part Number	Dash Size	Hose ID Size		F Thread		C Cut-Off Factor (mm)	D Drop (mm)	Hex Dia. CH2 (mm)	Weight (lbs/each)
		(in)	(mm)	Dash Size	Size (in) - TPI				
A-0404-F09M	04	1/4	6.4	04	9/16-18	29.8	32	17	0.10
A-0406-F09M	04	1/4	6.4	06	11/16-16	37.3	38	22	0.15
A-0506-F09M	05	5/16	7.9	06	11/16-16	40.7	34	22	0.18
A-0606-F09M	06	3/8	9.5	06	11/16-16	41.8	38	22	0.16
A-0608-F09M	06	3/8	9.5	08	13/16-16	43.8	41	24	0.22
A-0808-F09M	08	1/2	12.7	08	13/16-16	34.8	42	24	0.25
A-0810-F09M	08	1/2	12.7	10	1-14	48.3	47	30	0.36
A-1010-F09M	10	5/8	15.9	10	1-14	55.4	44	30	0.42
A-1212-F09M	12	3/4	19.0	12	1 3/16-12	61.6	58	36	0.69
A-1216-F09M	12	3/4	19.0	16	1 7/16-12	65.6	71	41	0.88
A-1616-F09M	16	1	25.4	16	1 7/16-12	82.6	66	41	1.08
A-2020-F09M	20	1 1/4	31.8	20	1 11/16-12	97.0	78	50	1.64
A-2424-F09M	24	1 1/2	38.1	24	2-12	107.8	87	60	2.30

Because we continually examine ways to improve our products, we reserve the right to alter specifications or discontinue products without prior notice.

Two-Piece Fittings - A Series



Inserts for two-piece fittings – US End Configurations

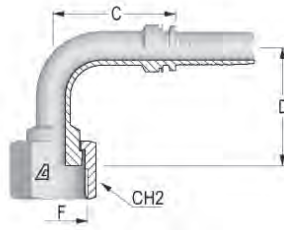

90° ORFS Female Swivel Long Drop

Part Number	Dash Size	Hose ID Size		F Thread		C Cut-Off Factor (mm)	D Drop (mm)	Hex Dia. CH2 (mm)	Weight (lbs/each)
		(in)	(mm)	Dash Size	Size (in) - TPI				
A-0404-F09L	04	1/4	6.4	04	9/16-18	32.8	46	17	0.11
A-0406-F09L	04	1/4	6.4	06	11/16-16	34.8	54	22	0.16
A-0506-F09L	05	5/16	7.9	06	11/16-16	31.5	54	22	0.19
A-0606-F09L	06	3/8	9.5	06	11/16-16	41.8	54	22	0.19
A-0608-F09L	06	3/8	9.5	08	13/16-16	46.8	64	24	0.24
A-0808-F09L	08	1/2	12.7	08	13/16-16	38.3	64	24	0.27
A-0810-F09L	08	1/2	12.7	10	1-14	46.3	70	30	0.39
A-1010-F09L	10	5/8	15.9	10	1-14	55.4	70	30	0.48
A-1012-F09L	10	5/8	15.9	12	1 3/16-12	55.4	96	30	0.41
A-1212-F09L	12	3/4	19.0	12	1 3/16-12	61.6	96	36	0.80
A-1216-F09L	12	3/4	19.0	16	1 7/16-12	61.6	118	41	0.95
A-1616-F09L	16	1	25.4	16	1 7/16-12	82.6	114	41	1.28
A-2020-F09L	20	1 1/4	31.8	20	1 11/16-12	97.0	129	50	1.95
A-2024-F09L	20	1 1/4	31.8	24	2-12	102.0	141	60	1.98
A-2424-F09L	24	1 1/2	38.1	24	2-12	110.8	141	60	2.75

Because we continually examine ways to improve our products, we reserve the right to alter specifications or discontinue products without prior notice.



HOSES
ONE-PIECE B SERIES
ONE-PIECE D SERIES
ONE-PIECE F & P SERIES
TWO-PIECE FERRULES (A & PFR SERIES)
TWO-PIECE INSERTS (A SERIES)
TWO-PIECE INTERLOCK FERRULES & INSERTS (X & Z SERIES)
QUICK RELEASE
ASSEMBLY EQUIPMENT
TECHNICAL INFORMATION

Inserts for two-piece fittings – US End Configurations

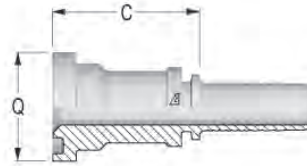

For Code 61 Split Flange Clamps, please refer to page 195.

O-Ring Flange SAE J518 Code 61

Part Number	Dash Size	Hose ID Size		Q Flange		C Cut-Off Factor (mm)	Max. Working Pressure (psi)	Weight (lbs/each)
		(in)	(mm)	(in)	(mm)			
A-0808-C61S	08	1/2	12.7	1.19	30.2	41.0	5000	0.25
A-0812-C61S	08	1/2	12.7	1.50	38.1	42.0	5000	0.35
A-1212-C61S	12	3/4	19.0	1.50	38.1	42.5	5000	0.43
A-1216-C61S	12	3/4	19.0	1.75	44.5	50.5	5000	0.56
A-1616-C61S	16	1	25.4	1.75	44.5	51.4	5000	0.75
A-1620-C61S	16	1	25.4	2.00	50.8	53.9	4000	0.77
A-2020-C61S	20	1 1/4	31.8	2.00	50.8	55.5	4000	0.94
A-2024-C61S	20	1 1/4	31.8	2.38	60.3	58.5	3000	1.12
A-2424-C61S	24	1 1/2	38.1	2.38	60.3	58.5	3000	1.27
A-2432-C61S	24	1 1/2	38.1	2.81	71.4	70.0	3000	1.98
A-3232-C61S	32	2	50.8	2.81	71.4	70.0	3000	2.05
A-4040-C61S	40	2 1/2	63.5	3.31	84.1	117.0	2500	2.30

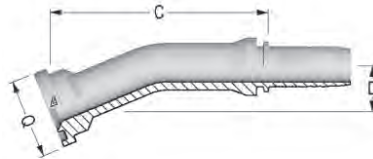

For Code 61 Split Flange Clamps, please refer to page 195.

22° O-Ring Flange SAE J518 Code 61

Part Number	Dash Size	Hose ID Size		Q Flange		C Cut-Off Factor (mm)	D Drop (mm)	Weight (lbs/each)
		(in)	(mm)	(in)	(mm)			
A-1616-C612	16	1	25.4	1.75	44.5	86.4	12.0	1.01
A-2020-C612	20	1 1/4	31.8	2.00	50.8	100.6	16.0	1.29
A-2024-C612	20	1 1/4	31.8	2.38	60.3	117.0	20.5	1.54
A-2424-C612	24	1 1/2	38.1	2.38	60.3	133.5	22.0	1.79

Because we continually examine ways to improve our products, we reserve the right to alter specifications or discontinue products without prior notice.

Two-Piece Fittings - A Series



Inserts for two-piece fittings – US End Configurations

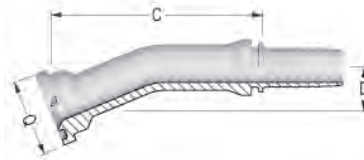

For Code 61 Split Flange Clamps, please refer to page 195.

30° O-Ring Flange SAE J518 Code 61

Part Number	Dash Size	Hose ID Size		Q Flange		C Cut-Off Factor (mm)	D Drop (mm)	Weight (lbs/each)
		(in)	(mm)	(in)	(mm)			
A-1212-C613	12	3/4	19.0	1.50	38.1	67.7	12.0	0.62
A-1216-C613	12	3/4	19.0	1.75	44.5	70.7	12.0	0.74
A-1616-C613	16	1	25.4	1.75	44.5	69.3	12.0	0.84
A-1620-C613	16	1	25.4	2.00	50.8	67.1	12.0	0.93
A-2020-C613	20	1 1/4	31.8	2.00	50.8	74.3	12.0	1.10
A-2024-C613	20	1 1/4	31.8	2.38	60.3	81.5	13.0	1.26
A-2424-C613	24	1 1/2	38.1	2.38	60.3	136.0	23.0	1.90
A-2432-C613	24	1 1/2	38.1	2.81	71.4	136.9	29.5	2.54

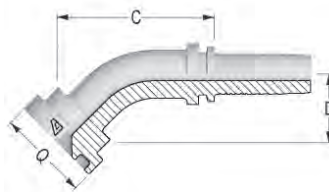

For Code 61 Split Flange Clamps, please refer to page 195.

45° O-Ring Flange SAE J518 Code 61

Part Number	Dash Size	Hose ID Size		Q Flange		C Cut-Off Factor (mm)	D Drop (mm)	Max. Working Pressure (psi)	Weight (lbs/each)
		(in)	(mm)	(in)	(mm)				
A-0808-C614	08	1/2	12.7	1.19	30.2	43.7	22.0	5000	0.27
A-0812-C614	08	1/2	12.7	1.50	38.1	50.4	26.0	5000	0.38
A-1012-C614	10	5/8	15.9	1.50	38.1	55.1	26.0	5000	0.40
A-1212-C614	12	3/4	19.0	1.50	38.1	63.8	32.0	5000	0.50
A-1216-C614	12	3/4	19.0	1.75	44.5	68.0	29.0	5000	0.60
A-1616-C614	16	1	25.4	1.75	44.5	72.8	33.5	5000	0.85
A-1620-C614	16	1	25.4	2.00	50.8	72.3	36.0	4000	0.92
A-2020-C614	20	1 1/4	31.8	2.00	50.8	85.2	37.5	4000	1.13
A-2024-C614	20	1 1/4	31.8	2.38	60.3	92.8	40.0	3000	1.27
A-2424-C614	24	1 1/2	38.1	2.38	60.3	105.4	48.0	3000	1.32
A-2432-C614	24	1 1/2	38.1	2.81	71.4	124.3	55.5	3000	2.65
A-3232-C614	32	2	50.8	2.81	71.4	129.5	47.5	3000	3.48
A-4040-C614	40	2 1/2	63.5	3.31	84.1	162.0	115.0	2500	3.80

Because we continually examine ways to improve our products, we reserve the right to alter specifications or discontinue products without prior notice.



HOSES
ONE-PIECE B SERIES
ONE-PIECE D SERIES
ONE-PIECE F & P SERIES
TWO-PIECE FERRULES (A & PFR SERIES)
TWO-PIECE INSERTS (A SERIES)
TWO-PIECE INTERLOCK FERRULES & INSERTS (X & Z SERIES)
QUICK RELEASE
ASSEMBLY EQUIPMENT
TECHNICAL INFORMATION

Inserts for two-piece fittings – US End Configurations

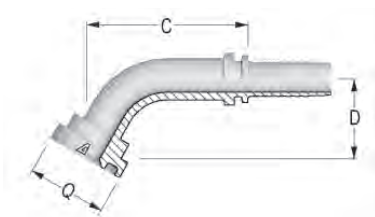

For Code 61 Split Flange Clamps, please refer to page 195.

60° O-Ring Flange SAE J518 Code 61

Part Number	Dash Size	Hose ID Size		Q Flange		C Cut-Off Factor (mm)	D Drop (mm)	Max. Working Pressure (psi)	Weight (lbs/each)
		(in)	(mm)	(in)	(mm)				
A-1212-C616	12	3/4	19.0	1.19	30.2	86.0	37.0	5000	0.29
A-1216-C616	12	3/4	19.0	1.75	44.5	102.0	44.0	5000	0.43
A-1616-C616	16	1	25.4	1.75	44.5	101.0	47.0	5000	0.55
A-1620-C616	16	1	25.4	2.00	50.8	106.5	43.5	5000	0.65
A-2020-C616	20	1 1/4	31.8	2.00	50.8	129.5	56.5	5000	0.71
A-2424-C616	24	1 1/2	38.1	2.38	60.3	151.0	57.0	3000	2.95
A-3232-C616	32	2	50.8	2.81	71.4	164.4	92.0	3000	4.30

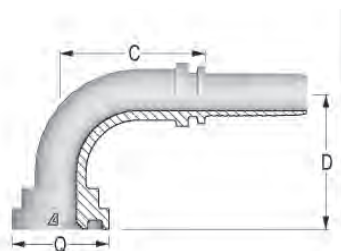

For Code 61 Split Flange Clamps, please refer to page 195.

90° O-Ring Flange SAE J518 Code 61

Part Number	Dash Size	Hose ID Size		Q Flange		C Cut-Off Factor (mm)	D Drop (mm)	Max. Working Pressure (psi)	Weight (lbs/each)
		(in)	(mm)	(in)	(mm)				
A-0808-C619	08	1/2	12.7	1.19	30.2	45.8	42.0	5000	0.29
A-0812-C619	08	1/2	12.7	1.50	38.1	45.3	51.0	5000	0.43
A-1012-C619	10	5/8	15.9	1.50	38.1	49.4	51.0	5000	0.55
A-1212-C619	12	3/4	19.0	1.50	38.1	57.7	60.0	5000	0.65
A-1216-C619	12	3/4	19.0	1.75	44.5	66.2	64.5	5000	0.71
A-1616-C619	16	1	25.4	1.75	44.5	70.6	67.0	5000	0.88
A-1620-C619	16	1	25.4	2.00	50.8	73.6	71.0	4000	1.02
A-2020-C619	20	1 1/4	31.8	2.00	50.8	88.0	84.0	4000	1.30
A-2024-C619	20	1 1/4	31.8	2.38	60.3	91.5	87.5	3000	1.48
A-2424-C619	24	1 1/2	38.1	2.38	60.3	104.8	91.0	3000	1.26
A-2432-C619	24	1 1/2	38.1	2.81	71.4	104.8	115.0	3000	2.66
A-3232-C619	32	2	50.8	2.81	71.4	127.2	130.0	3000	4.30
A-4040-C619	40	2 1/2	63.5	3.31	84.1	137.0	125.0	2500	4.80

Because we continually examine ways to improve our products, we reserve the right to alter specifications or discontinue products without prior notice.

Two-Piece Fittings - A Series



Inserts for two-piece fittings – US End Configurations

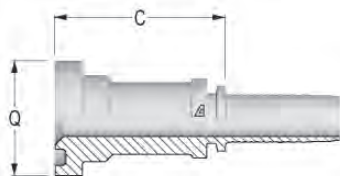

For Code 62 Split Flange Clamps, please refer to page 198.

O-Ring Flange SAE J518 Code 62

Part Number	Dash Size	Hose ID Size		Q Flange		C Cut-Off Factor (mm)	Max. Working Pressure (psi)	Weight (lbs/each)
		(in)	(mm)	(in)	(mm)			
A-0808-C62S	08	1/2	12.7	1.25	31.8	46.6	6000	0.50
A-0812-C62S	08	1/2	12.7	1.63	41.3	67.2	6000	0.52
A-1212-C62S	12	3/4	19.0	1.63	41.3	52.5	6000	0.54
A-1216-C62S	12	3/4	19.0	1.88	47.6	55.5	6000	0.70
A-1616-C62S	16	1	25.4	1.88	47.6	56.4	6000	0.81
A-1620-C62S	16	1	25.4	1.88	54.0	63.4	6000	1.08
A-2020-C62S	20	1 1/4	31.8	2.13	54.0	83.0	6000	1.45
A-2024-C62S	20	1 1/4	31.8	2.13	63.5	71.0	6000	1.88
A-2424-C62S	24	1 1/2	38.1	2.50	63.5	101.0	6000	2.05
A-2432-C62S	24	1 1/2	38.1	2.50	79.4	76.0	6000	2.87
A-3232-C62S	32	2	50.8	3.13	79.4	76.0	6000	3.53

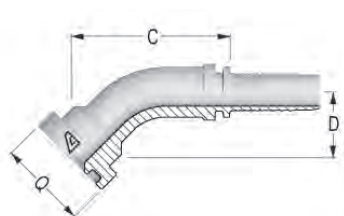

For Code 62 Split Flange Clamps, please refer to page 198.

45° O-Ring Flange SAE J518 Code 62

Part Number	Dash Size	Hose ID Size		Q Flange		C Cut-Off Factor (mm)	D Drop (mm)	Max. Working Pressure (psi)	Weight (lbs/each)
		(in)	(mm)	(in)	(mm)				
A-0808-C624	08	1/2	12.7	1.25	31.8	46.6	23.0	6000	0.30
A-0812-C624	08	1/2	12.7	1.63	41.3	67.2	30.5	6000	0.55
A-1212-C624	12	3/4	19.0	1.63	41.3	71.4	31.0	6000	0.60
A-1216-C624	12	3/4	19.0	1.88	47.6	65.2	33.5	6000	0.78
A-1616-C624	16	1	25.4	1.88	47.6	81.9	36.0	6000	0.94
A-1620-C624	16	1	25.4	2.13	54.0	78.4	39.0	6000	1.22
A-2020-C624	20	1 1/4	31.8	2.13	54.0	90.9	40.0	6000	1.65
A-2024-C624	20	1 1/4	31.8	2.50	63.5	93.6	45.5	6000	1.98
A-2424-C624	24	1 1/2	38.1	2.50	63.5	101.7	45.0	6000	2.43
A-2432-C624	24	1 1/2	38.1	3.13	79.4	106.4	57.5	6000	2.21
A-3232-C624	32	2	50.8	3.13	79.4	129.7	60.0	6000	4.09

Because we continually examine ways to improve our products, we reserve the right to alter specifications or discontinue products without prior notice.



HOSES

ONE-PIECE B SERIES

ONE-PIECE D SERIES

ONE-PIECE F & P SERIES

TWO-PIECE FERRULES (A & PFR SERIES)

TWO-PIECE INSERTS (A SERIES)

TWO-PIECE INTERLOCK FERRULES & INSERTS (X & Z SERIES)

QUICK RELEASE

ASSEMBLY EQUIPMENT

TECHNICAL INFORMATION

Inserts for two-piece fittings – US End Configurations

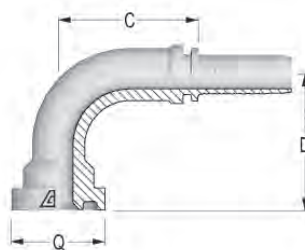

For Code 62 Split Flange Clamps, please refer to page 198.

90° O-Ring Flange SAE J518 Code 62

Part Number	Dash Size	Hose ID Size		Q Flange		C Cut-Off Factor (mm)	D Drop (mm)	Max. Working Pressure (psi)	Weight (lbs/each)
		(in)	(mm)	(in)	(mm)				
A-0808-C629	08	1/2	12.7	1.25	31.8	47.8	46	6000	0.33
A-0812-C629	08	1/2	12.7	1.63	41.3	47.8	54	6000	0.88
A-1212-C629	12	3/4	19.0	1.63	41.3	63.2	61	6000	0.62
A-1216-C629	12	3/4	19.0	1.88	47.6	63.2	66	6000	0.93
A-1616-C629	16	1	25.4	1.88	47.6	73.6	75	6000	1.05
A-1620-C629	16	1	25.4	2.13	54.0	77.6	78	6000	1.32
A-2020-C629	20	1 1/4	31.8	2.13	54.0	94.5	89	6000	1.59
A-2024-C629	20	1 1/4	31.8	2.50	63.5	98.0	94	6000	2.09
A-2424-C629	24	1 1/2	38.1	2.50	63.5	99.6	105	6000	2.57
A-2432-C629	24	1 1/2	38.1	3.13	79.4	114.7	123	6000	2.21
A-3232-C629	32	2	50.8	3.13	79.4	143.3	132	6000	2.32

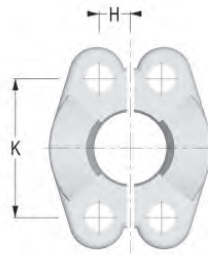

Split Flange Clamps SAE J518 Code 61 – 3000 PSI (2 Halves/Pieces per 1 Part)

Part Number	Flange Size (in)	H (mm)	K (mm)	Max. Working Pressure (psi)	Weight (lbs/each)
C61SF-08	1/2	8.7	38.1	3000	0.22
C61SF-12	3/4	11.1	47.6	3000	0.38
C61SF-16	1	13.1	52.4	3000	0.50
C61SF-20	1 1/4	15.1	58.7	3000	0.67
C61SF-24	1 1/2	17.9	69.9	3000	1.01
C61SF-32	2	21.4	77.8	3000	1.18
C61SF-40	2 1/2	25.5	89.0	2500	1.89

Note: Bolts, washers and o-ring are not included.

Because we continually examine ways to improve our products, we reserve the right to alter specifications or discontinue products without prior notice.

Two-Piece Fittings - A, V Series



Inserts for two-piece fittings – US End Configurations

NEW

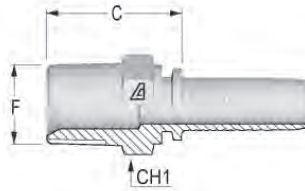

API Male NPT Extended Hex

Part Number	Dash Size	Hose ID Size		F Thread		C Cut-Off Factor (mm)	Hex Dia. CH1 (mm)	Hex Dia. CH2 (mm)	Weight (lbs/each)
		(in)	(mm)	Dash Size	Size (in) - TPI				
V-4040-MAPI	40	2 1/2	63.5	40	2 1/2-8	105	80	N/A	4.00
V-4848-MAPI	48	3	76.2	48	3-8	128	100	N/A	5.00

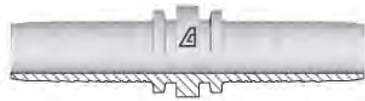

Hose Mender

Part Number	Dash Size	Hose ID Size		Weight (lbs/each)
		(in)	(mm)	
A-0404-HMEN	04	1/4	6.4	0.04
A-0505-HMEN	05	5/16	7.9	0.05
A-0606-HMEN	06	3/8	9.5	0.06
A-0808-HMEN	08	1/2	12.7	0.09
A-1010-HMEN	10	5/8	15.9	0.15
A-1212-HMEN	12	3/4	19.0	0.21
A-1616-HMEN	16	1	25.4	0.28
A-2020-HMEN	20	1 1/4	31.8	0.30
A-2424-HMEN	24	1 1/2	38.1	0.35
A-3232-HMEN	32	2	50.8	0.44

Because we continually examine ways to improve our products, we reserve the right to alter specifications or discontinue products without prior notice.



HOSES
ONE-PIECE B SERIES
ONE-PIECE D SERIES
ONE-PIECE F & P SERIES
TWO-PIECE FERRULES (A & PFR SERIES)
TWO-PIECE INSERTS (A SERIES)
TWO-PIECE INTERLOCK FERRULES & INSERTS (X & Z SERIES)
QUICK RELEASE
ASSEMBLY EQUIPMENT
TECHNICAL INFORMATION



Lined area for handwritten notes, consisting of 30 horizontal lines.

HOSES
ONE-PIECE B SERIES
ONE-PIECE D SERIES
ONE-PIECE F & P SERIES
TWO-PIECE FERRULES (A & PFR SERIES)
TWO-PIECE INSERTS (A SERIES)
TWO-PIECE INTERLOCK FERRULES & INSERTS (X & Z SERIES)
QUICK RELEASE
ASSEMBLY EQUIPMENT

Because we continually examine ways to improve our products, we reserve the right to alter specifications or discontinue products without prior notice.



Two-Piece Fittings - A, C62SF Series



Inserts for two-piece fittings – US End Configurations

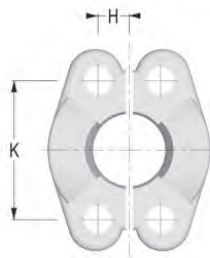

Split Flange Clamps SAE J518 Code 62 – 6000 PSI (2 Halves/Pieces per 1 Part)

Part Number	Flange Size (in)	H (mm)	K (mm)	Max. Working Pressure (psi)	Weight (lbs/each)
C62SF-08	1/2	9.1	40.5	6000	0.35
C62SF-12	3/4	11.9	50.8	6000	0.71
C62SF-16	1	13.9	57.2	6000	1.43
C62SF-20	1 1/4	15.9	66.7	6000	1.76
C62SF-24	1 1/2	18.3	79.4	6000	3.09
C62SF-32	2	22.2	96.8	6000	4.41

Note: Bolts, washers and o-ring are not included.

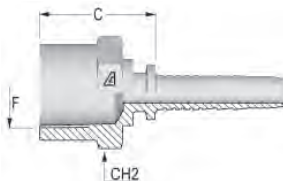

Grease Fitting

Part Number	Dash Size	Hose ID Size		F Thread Size (in)	C Cut-Off Factor (mm)	Hex Dia. CH2 (mm)	Weight (lbs/each)
		(in)	(mm)				
A-0404-FGRT	04	1/4	6.4	1/2-27	23.3	19	0.07

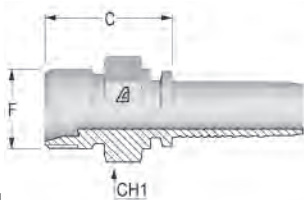

Bite Type Tube Fitting

Part Number	Dash Size	Hose ID Size		F Thread Size (in)	C Cut-Off Factor (mm)	Hex Dia. CH1 (mm)	Weight (lbs/each)
		(in)	(mm)				
A-0404-BTTF	04	1/4	6.4	7/16-20	21.8	12	0.06
A-0506-BTTF	05	5/16	7.9	9/16-18	24.2	16	0.08
A-0606-BTTF	06	3/8	9.5	9/16-18	24.2	16	0.09
A-0808-BTTF	08	1/2	12.7	3/4-16	28.4	22	0.14
A-1212-BTTF	12	3/4	19.0	1 1/16-12	33.1	30	0.09

Because we continually examine ways to improve our products, we reserve the right to alter specifications or discontinue products without prior notice.



HOSES

ONE-PIECE B SERIES

ONE-PIECE D SERIES

ONE-PIECE F & P SERIES

TWO-PIECE FERRULES (A & PFR SERIES)

TWO-PIECE INSERTS (A SERIES)

TWO-PIECE INTERLOCK FERRULES & INSERTS (X & Z SERIES)

QUICK RELEASE

ASSEMBLY EQUIPMENT

TECHNICAL INFORMATION

Inserts for two-piece fittings – International End Configurations

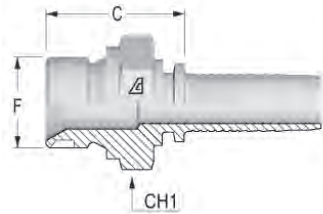

BSP Male Parallel 60° Seat

Part Number	Dash Size	Hose ID Size		F Thread		C Cut-Off Factor (mm)	Hex Dia. CH1 (mm)	Weight (lbs/each)
		(in)	(mm)	Dash Size	Size (in) - TPI			
A-0302-MBPP	03	3/16	4.8	02	1/8-28	21.3	14	0.04
A-0402-MBPP	04	1/4	6.4	02	1/8-28	21.7	14	0.04
A-0404-MBPP	04	1/4	6.4	04	1/4-19	26.3	19	0.07
A-0406-MBPP	04	1/4	6.4	06	3/8-19	27.8	22	0.10
A-0506-MBPP	05	5/16	7.9	06	3/8-19	27.8	22	0.11
A-0604-MBPP	06	3/8	9.5	04	1/4-19	26.3	19	0.11
A-0606-MBPP	06	3/8	9.5	06	3/8-19	27.8	22	0.11
A-0608-MBPP	06	3/8	9.5	08	1/2-14	31.3	27	0.18
A-0806-MBPP	08	1/2	12.7	06	3/8-19	28.6	22	0.14
A-0808-MBPP	08	1/2	12.7	08	1/2-14	32.1	27	0.20
A-0810-MBPP	08	1/2	12.7	10	5/8-14	36.1	30	0.27
A-0812-MBPP	08	1/2	12.7	12	3/4-14	34.1	32	0.27
A-1008-MBPP	10	5/8	15.9	08	1/2-14	34.1	30	0.27
A-1010-MBPP	10	5/8	15.9	10	5/8-14	36.1	30	0.27
A-1012-MBPP	10	5/8	15.9	12	3/4-14	34.1	32	0.29
A-1212-MBPP	12	3/4	19.0	12	3/4-14	34.6	32	0.31
A-1216-MBPP	12	3/4	19.0	16	1-11	39.6	41	0.53
A-1612-MBPP	16	1	25.4	12	3/4-14	40.2	41	0.55
A-1616-MBPP	16	1	25.4	16	1-11	40.4	41	0.58
A-1620-MBPP	16	1	25.4	20	1 1/4-11	42.4	50	0.82
A-2020-MBPP	20	1 1/4	31.8	20	1 1/4-11	47.0	50	0.98
A-2424-MBPP	24	1 1/2	38.1	24	1 1/2-11	49.0	55	1.19
A-3232-MBPP	32	2	50.8	32	2-11	53.5	70	2.01

Because we continually examine ways to improve our products, we reserve the right to alter specifications or discontinue products without prior notice.

Two-Piece Fittings - A Series



HOSES

ONE-PIECE
B SERIES

ONE-PIECE
D SERIES

ONE-PIECE
F & P SERIES

TWO-PIECE FERRULES
(A & PFR SERIES)

TWO-PIECE INSERTS
(A SERIES)

TWO-PIECE INTERLOCK
FERRULES & INSERTS
(X & Z SERIES)

QUICK
RELEASE

ASSEMBLY
EQUIPMENT

TECHNICAL
INFORMATION

Inserts for two-piece fittings – International End Configurations

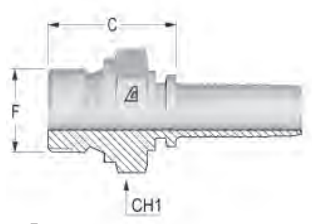

BSP Male Flat Seat

Part Number	Dash Size	Hose ID Size		F Thread		C Cut-Off Factor (mm)	Hex Dia. CH1 (mm)	Weight (lbs/each)
		(in)	(mm)	Dash Size	Size (in) - TPI			
A-0404-MBFS	04	1/4	6.4	04	1/4-11	26.3	19	0.09
A-0606-MBFS	06	3/8	9.5	06	3/8-19	27.8	22	0.11
A-0608-MBFS	06	3/8	9.5	08	1/2-14	31.3	27	0.20
A-0808-MBFS	08	1/2	12.7	08	1/2-14	32.1	27	0.13
A-1010-MBFS	10	5/8	15.9	10	5/8-14	36.1	30	0.28
A-1212-MBFS	12	3/4	19.0	12	3/4-14	34.6	32	0.22
A-1616-MBFS	16	1	25.4	16	1-11	40.4	41	0.44

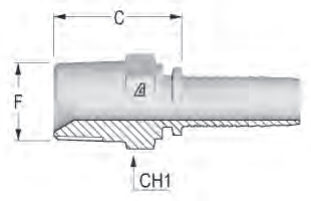

BSPT/JIS Male Tapered

Part Number	Dash Size	Hose ID Size		F Thread		C Cut-Off Factor (mm)	Hex Dia. CH1 (mm)	Weight (lbs/each)
		(in)	(mm)	Dash Size	Size (in) - TPI			
A-0302-MBPT	03	3/16	4.8	02	1/8-28	20.8	12	0.03
A-0402-MBPT	04	1/4	6.4	02	1/8-28	22.3	12	0.04
A-0404-MBPT	04	1/4	6.4	04	1/4-19	26.3	17	0.06
A-0406-MBPT	04	1/4	6.4	06	3/8-19	26.3	19	0.08
A-0506-MBPT	05	5/16	7.9	06	3/8-19	26.3	19	0.09
A-0606-MBPT	06	3/8	9.5	06	3/8-19	26.3	19	0.09
A-0608-MBPT	06	3/8	9.5	08	1/2-14	33.3	22	0.15
A-0808-MBPT	08	1/2	12.7	08	1/2-14	34.1	22	0.17
A-1012-MBPT	10	5/8	15.9	12	3/4-14	34.1	27	0.27
A-1212-MBPT	12	3/4	19.0	12	3/4-14	34.6	27	0.27
A-1216-MBPT	12	3/4	19.0	16	1-11	42.6	36	0.44
A-1616-MBPT	16	1	25.4	16	1-11	43.4	36	0.53
A-2020-MBPT	20	1 1/4	31.8	20	1 1/4-11	49.0	46	0.90
A-2424-MBPT	24	1 1/2	38.1	24	1 1/2-11	49.0	50	1.08
A-3232-MBPT	32	2	50.8	32	2-11	52.0	65	1.76

Because we continually examine ways to improve our products, we reserve the right to alter specifications or discontinue products without prior notice.

Inserts for two-piece fittings – International End Configurations

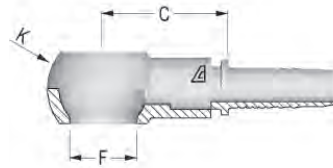

BSP Banjo - RNR

Part Number	Dash Size	Hose ID Size		F Thread Size (in) - TPI	F (mm)	C Cut-Off Factor (mm)	K (mm)	Weight (lbs/each)
		(in)	(mm)					
A-0402-BBAN	04	1/4	6.4	1/8-28	10.1	20.0	17	0.06
A-0404-BBAN	04	1/4	6.4	1/4-19	13.3	26.5	22	0.07
A-0406-BBAN	04	1/4	6.4	3/8-19	16.7	30.5	28	0.08
A-0506-BBAN	05	5/16	7.9	3/8-19	16.7	30.5	28	0.10
A-0606-BBAN	06	3/8	9.5	3/8-19	16.7	30.5	28	0.10
A-0608-BBAN	06	3/8	9.5	1/2-14	21.0	34.5	38	0.19
A-0808-BBAN	08	1/2	12.7	1/2-14	21.0	35.0	38	0.20
A-1010-BBAN	10	5/8	15.9	5/8-14	23.0	38.0	40	0.27
A-1212-BBAN	12	3/4	19.0	3/4-14	26.5	41.5	46	0.44
A-1616-BBAN	16	1	25.4	1-11	33.3	50.5	58	0.82

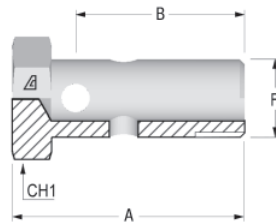

BSPP Bolt

Part Number	F Thread Size (in) - TPI	A (mm)	B (mm)	CH1 (mm)	Weight (lbs/each)
BBOLT-04	1/4-19	30	25	19	0.08
BBOLT-06	3/8-19	38	31	22	0.13
BBOLT-08	1/2-14	46	38	27	0.21
BBOLT-10	5/8-14	51	42	28	0.21
BBOLT-12	3/4-14	56	47	32	0.37
BBOLT-16	1-11	69	58	38	0.76

Because we continually examine ways to improve our products, we reserve the right to alter specifications or discontinue products without prior notice.

Two-Piece Fittings - A Series



HOSES

ONE-PIECE
B SERIES

ONE-PIECE
D SERIES

ONE-PIECE
F & P SERIES

TWO-PIECE FERRULES
(A & PFR SERIES)

TWO-PIECE INSERTS
(A SERIES)

TWO-PIECE INTERLOCK
FERRULES & INSERTS
(X & Z SERIES)

QUICK
RELEASE

ASSEMBLY
EQUIPMENT

TECHNICAL
INFORMATION

Inserts for two-piece fittings – International End Configurations

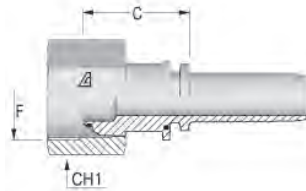

BSP O-Ring Female Swivel 60° Cone

Part Number	Dash Size	Hose ID Size		F Thread		C Cut-Off Factor (mm)	Hex Dia. CH1 (mm)	Weight (lbs/each)
		(in)	(mm)	Dash Size	Size (in) - TPI			
A-0302-FBPP	03	3/16	4.8	02	1/8-28	13.5	14	0.03
A-0304-FBPO	03	3/16	4.8	04	1/4-19	16.0	19	0.04
A-0402-FBPP	04	1/4	6.4	02	1/8-28	14.5	14	0.04
A-0404-FBPO	04	1/4	6.4	04	1/4-19	16.0	19	0.06
A-0406-FBPO	04	1/4	6.4	06	3/8-19	16.0	22	0.09
A-0504-FBPO	05	5/16	7.9	04	1/4-19	17.3	19	0.07
A-0506-FBPO	05	5/16	7.9	06	3/8-19	18.0	22	0.09
A-0604-FBPO	06	3/8	9.5	04	1/4-19	17.3	19	0.09
A-0606-FBPO	06	3/8	9.5	06	3/8-19	17.0	22	0.10
A-0608-FBPO	06	3/8	9.5	08	1/2-14	17.0	27	0.15
A-0806-FBPO	08	1/2	12.7	06	3/8-19	18.6	22	0.13
A-0808-FBPO	08	1/2	12.7	08	1/2-14	18.0	27	0.16
A-0810-FBPO	08	1/2	12.7	10	5/8-14	17.0	27	0.19
A-0812-FBPO	08	1/2	12.7	12	3/4-14	22.0	32	0.22
A-1010-FBPO	10	5/8	15.9	10	5/8-14	17.1	27	0.21
A-1012-FBPO	10	5/8	15.9	12	3/4-14	20.0	32	0.26
A-1212-FBPO	12	3/4	19.0	12	3/4-14	20.6	32	0.26
A-1216-FBPO	12	3/4	19.0	16	1-11	23.0	38	0.02
A-1616-FBPO	16	1	25.4	16	1-11	23.9	38	0.44
A-1620-FBPO	16	1	25.4	20	1 1/4-11	30.5	50	0.90
A-2020-FBPO	20	1 1/4	31.8	20	1 1/4-11	32.0	50	0.98
A-2024-FBPO	20	1 1/4	31.8	24	1 1/2-11	41.9	55	1.32
A-2424-FBPO	24	1 1/2	38.1	24	1 1/2-11	33.8	55	1.65
A-2432-FBPO	24	1 1/2	38.1	32	2-11	36.0	70	1.98
A-3232-FBPO	32	2	50.8	32	2-11	34.0	70	2.12

Because we continually examine ways to improve our products, we reserve the right to alter specifications or discontinue products without prior notice.



Inserts for two-piece fittings – International End Configurations

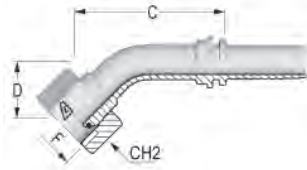

45° BSP O-Ring Female Swivel 60° Cone

Part Number	Dash Size	Hose ID Size		F Thread		C Cut-Off Factor (mm)	D Drop (mm)	Hex Dia. CH2 (mm)	Weight (lbs/each)
		(in)	(mm)	Dash Size	Size (in) - TPI				
A-0302-FBP4	03	3/16	4.8	02	1/8-28	36.0	16.0	14	0.03
A-0402-FBP4	04	1/4	6.4	02	1/8-28	42.0	16.0	14	0.04
A-0404-FB04	04	1/4	6.4	04	1/4-19	44.5	15.0	19	0.10
A-0406-FB04	04	1/4	6.4	06	3/8-19	43.0	16.9	22	0.14
A-0506-FB04	05	5/16	7.9	06	3/8-19	48.0	18.0	22	0.16
A-0606-FB04	06	3/8	9.5	06	3/8-19	50.0	20.5	22	0.15
A-0608-FB04	06	3/8	9.5	08	1/2-14	53.5	21.0	27	0.15
A-0808-FB04	08	1/2	12.7	08	1/2-14	56.0	21.0	27	0.24
A-0810-FB04	08	1/2	12.7	10	5/8-14	61.0	23.0	27	0.34
A-0812-FB04	08	1/2	12.7	12	3/4-14	56.7	23.0	32	0.35
A-1010-FB04	10	5/8	15.9	10	5/8-14	64.0	21.5	27	0.24
A-1012-FB04	10	5/8	15.9	12	3/4-14	69.0	22.5	32	0.44
A-1212-FB04	12	3/4	19.0	12	3/4-14	67.6	28.0	32	0.44
A-1216-FB04	12	3/4	19.0	16	1-11	77.5	31.5	38	0.46
A-1616-FB04	16	1	25.4	16	1-11	72.5	34.0	38	1.00
A-1620-FB04	16	1	25.4	20	1 1/4-11	102.0	47.5	50	0.99
A-2020-FB04	20	1 1/4	31.8	20	1 1/4-11	101.0	40.0	50	1.32
A-2024-FB04	20	1 1/4	31.8	24	1 1/2-11	108.0	46.0	55	1.98
A-2424-FB04	24	1 1/2	38.1	24	1 1/2-14	111.0	46.0	55	2.66
A-2432-FB04	24	1 1/2	38.1	32	2-11	124.0	51.0	70	2.87
A-3232-FB04	32	2	50.8	32	2-11	154.0	60.0	70	3.94

Because we continually examine ways to improve our products, we reserve the right to alter specifications or discontinue products without prior notice.

Two-Piece Fittings - A Series



HOSES

ONE-PIECE
B SERIES

ONE-PIECE
D SERIES

ONE-PIECE
F & P SERIES

TWO-PIECE FERRULES
(A & PFR SERIES)

TWO-PIECE INSERTS
(A SERIES)

TWO-PIECE INTERLOCK
FERRULES & INSERTS
(X & Z SERIES)

QUICK
RELEASE

ASSEMBLY
EQUIPMENT

TECHNICAL
INFORMATION

Inserts for two-piece fittings – International End Configurations

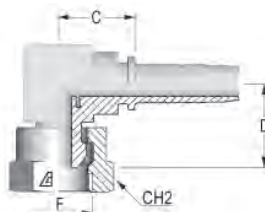

90° BSP Compact Female Elbow 60° Cone

Part Number	Dash Size	Hose ID Size		F Thread		C Cut-Off Factor (mm)	D Drop (mm)	Hex Dia. CH2 (mm)	Weight (lbs/each)
		(in)	(mm)	Dash Size	Size (in) - TPI				
A-0404-FBC9	04	1/4	6.4	04	1/4-19	16.8	19.5	19	0.11
A-0506-FBC9	05	5/16	7.9	06	3/8-19	19.5	21.5	22	0.16
A-0606-FBC9	06	3/8	9.5	06	3/8-19	19.5	21.5	22	0.20
A-0608-FBC9	06	3/8	9.5	08	1/2-14	21.5	22.5	27	0.29
A-0808-FBC9	08	1/2	12.7	08	1/2-14	22.2	22.5	27	0.31
A-1212-FBC9	12	3/4	19.0	12	3/4-14	26.7	31.0	32	0.39
A-1616-FBC9	16	1	25.4	16	1-11	34.5	27.5	38	0.47

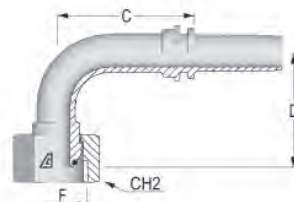

90° BSP O-Ring Female Swivel 60° Cone

Part Number	Dash Size	Hose ID Size		F Thread		C Cut-Off Factor (mm)	D Drop (mm)	Hex Dia. CH2 (mm)	Weight (lbs/each)
		(in)	(mm)	Dash Size	Size (in) - TPI				
A-0302-FBP9	03	3/16	4.8	02	1/8-28	25.0	29.0	14	0.06
A-0402-FBP9	04	1/4	6.4	02	1/8-28	27.0	30.0	14	0.08
A-0404-FB09	04	1/4	6.4	04	1/4-19	29.3	29.0	19	0.10
A-0406-FB09	04	1/4	6.4	06	3/8-19	28.0	30.5	22	0.13
A-0506-FB09	05	5/16	7.9	06	3/8-19	34.0	35.5	22	0.15
A-0606-FB09	06	3/8	9.5	06	3/8-19	39.5	42.0	22	0.15
A-0608-FB09	06	3/8	9.5	08	1/2-14	33.0	36.0	27	0.21
A-0808-FB09	08	1/2	12.7	08	1/2-14	40.0	41.0	27	0.24
A-0810-FB09	08	1/2	12.7	10	5/8-14	42.5	43.0	27	0.24
A-0812-FB09	08	1/2	12.7	12	3/4-14	42.5	43.0	32	0.28
A-1010-FB09	10	5/8	15.9	10	5/8-14	50.2	47.0	27	0.33
A-1012-FB09	10	5/8	15.9	12	3/4-14	48.0	46.0	32	0.42
A-1212-FB09	12	3/4	19.0	12	3/4-14	53.5	53.0	32	0.49
A-1216-FB09	12	3/4	19.0	16	1-11	54.0	50.0	38	0.66
A-1616-FB09	16	1	25.4	16	1-11	73.4	69.0	38	0.92

continued on the next page

Because we continually examine ways to improve our products, we reserve the right to alter specifications or discontinue products without prior notice.



Inserts for two-piece fittings – International End Configurations

(continued)

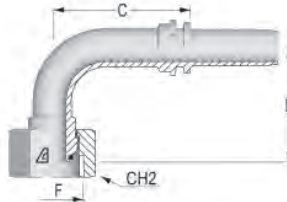

90° BSP O-Ring Female Swivel 60° Cone

Part Number	Dash Size	Hose ID Size		F Thread		C Cut-Off Factor (mm)	D Drop (mm)	Hex Dia. CH2 (mm)	Weight (lbs/each)
		(in)	(mm)	Dash Size	Size (in) - TPI				
A-1620-FB09	16	1	25.4	20	1 1/4-11	78.5	88.5	50	1.55
A-2020-FB09	20	1 1/4	31.8	20	1 1/4-11	83.0	83.0	50	1.72
A-2024-FB09	20	1 1/4	31.8	24	1 1/2-11	101.5	83.0	55	2.21
A-2424-FB09	24	1 1/2	38.1	24	1 1/2-11	96.0	96.0	55	2.98
A-2432-FB09	24	1 1/2	38.1	32	2-11	114.0	110.0	70	2.82
A-3232-FB09	32	2	50.8	32	2-11	138.0	136.0	70	4.41

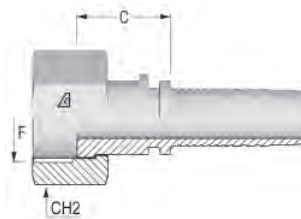

BSP Female Swivel Flat Seat

Part Number	Dash Size	Hose ID Size		F Thread		C Cut-Off Factor (mm)	Hex Dia. CH2 (mm)	Weight (lbs/each)
		(in)	(mm)	Dash Size	Size (in) - TPI			
A-0404-FBFS	04	1/4	6.4	04	1/4-19	20.3	19	0.06
A-0606-FBFS	06	3/8	9.5	06	3/8-19	20.3	22	0.09
A-0608-FBFS	06	3/8	9.5	08	1/2-14	20.8	27	0.14
A-0808-FBFS	08	1/2	12.7	08	1/2-14	21.6	27	0.16
A-0812-FBFS	08	1/2	12.7	12	3/4-14	24.6	32	0.23
A-1010-FBFS	10	5/8	15.9	10	5/8-14	15.3	27	0.22
A-1012-FBFS	10	5/8	15.9	12	3/4-14	17.6	32	0.44
A-1212-FBFS	12	3/4	19.0	12	3/4-14	18.0	32	0.26
A-1616-FBFS	16	1	25.4	16	1-11	19.9	38	0.40

Because we continually examine ways to improve our products, we reserve the right to alter specifications or discontinue products without prior notice.

Two-Piece Fittings - A Series



HOSES

ONE-PIECE
B SERIES

ONE-PIECE
D SERIES

ONE-PIECE
F & P SERIES

TWO-PIECE FERRULES
(A & PFR SERIES)

TWO-PIECE INSERTS
(A SERIES)

TWO-PIECE INTERLOCK
FERRULES & INSERTS
(X & Z SERIES)

QUICK
RELEASE

ASSEMBLY
EQUIPMENT

TECHNICAL
INFORMATION

Inserts for two-piece fittings – International End Configurations

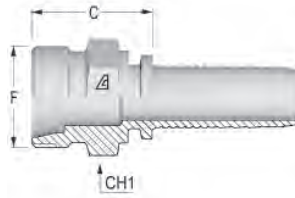

Metric Male 24° Seat – DIN 3853 Light

Part Number	Dash Size	Hose ID Size		F Thread Size (mm) x TP (mm)	Tube OD (mm)	C Cut-Off Factor (mm)	Hex Dia. CH1 (mm)	Weight (lbs/each)
		(in)	(mm)					
A-0414-MMSL	04	1/4	6.4	M14x1.5	8	22.3	14	0.04
A-0416-MMSL	04	1/4	6.4	M16x1.5	10	23.3	17	0.06
A-0516-MMSL	05	5/16	7.9	M16x1.5	10	23.3	17	0.06
A-0518-MMSL	05	5/16	7.9	M18x1.5	12	23.3	19	0.07
A-0616-MMSL	06	3/8	9.5	M16x1.5	10	23.3	17	0.07
A-0618-MMSL	06	3/8	9.5	M18x1.5	12	23.3	19	0.08
A-0622-MMSL	06	3/8	9.5	M22x1.5	15	25.3	22	0.11
A-0822-MMSL	08	1/2	12.7	M22x1.5	15	26.1	22	0.13
A-0826-MMSL	08	1/2	12.7	M26x1.5	18	27.1	27	0.19
A-1026-MMSL	10	5/8	15.9	M26x1.5	18	27.1	27	0.19
A-1230-MMSL	12	3/4	19.0	M30x2	22	29.6	32	0.26
A-1636-MMSL	16	1	25.4	M36x2	28	33.4	36	0.42
A-2045-MMSL	20	1 1/4	31.8	M45x2	35	40.0	46	0.79
A-2452-MMSL	24	1 1/2	38.1	M52x2	42	40.5	60	0.88

Because we continually examine ways to improve our products, we reserve the right to alter specifications or discontinue products without prior notice.



Inserts for two-piece fittings – International End Inserts

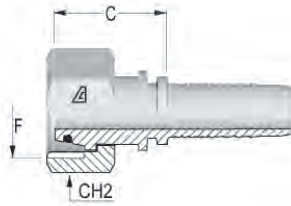

Metric O-Ring Female Swivel 24° Seat – DIN 3865 Light

Part Number	Dash Size	Hose ID Size		F Thread Size (mm) x TP (mm)	Tube OD (mm)	C Cut-Off Factor (mm)	Hex Dia. CH2 (mm)	Weight (lbs/each)
		(in)	(mm)					
A-0412-FMOL	04	1/4	6.4	M12x1.5	6	23.9	14	0.05
A-0414-FMOL	04	1/4	6.4	M14x1.5	8	24.4	17	0.06
A-0416-FMOL	04	1/4	6.4	M16x1.5	10	25.4	19	0.08
A-0516-FMOL	05	5/16	7.9	M16x1.5	10	25.4	19	0.09
A-0616-FMOL	06	3/8	9.5	M16x1.5	10	25.4	19	0.88
A-0618-FMOL	06	3/8	9.5	M18x1.5	12	25.4	22	0.12
A-0622-FMOL	06	3/8	9.5	M22x1.5	15	27.4	27	0.14
A-0822-FMOL	08	1/2	12.7	M22x1.5	15	28.2	27	0.19
A-1026-FMOL	10	5/8	15.9	M26x1.5	18	29.2	32	0.27
A-1226-FMOL	12	3/4	19.0	M26x1.5	18	25.5	32	0.35
A-1230-FMOL	12	3/4	19.0	M30x2	22	31.7	36	0.38
A-1636-FMOL	16	1	25.4	M36x2	28	33.6	41	0.53
A-2045-FMOL	20	1 1/4	31.8	M45x2	35	40.1	50	0.88
A-2452-FMOL	24	1 1/2	38.1	M52x2	42	40.5	60	1.28

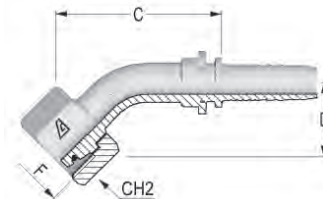

45° Metric O-Ring Female Swivel 24° Seat – DIN 3865 Light

Part Number	Dash Size	Hose ID Size		F Thread Size (mm) x TP (mm)	Tube OD (mm)	C Cut-Off Factor (mm)	D Drop (mm)	Hex Dia. CH2 (mm)	Weight (lbs/each)
		(in)	(mm)						
A-0414-FM4L	04	1/4	6.4	M14x1.5	8	42.7	17.5	17	0.08
A-0416-FM4L	04	1/4	6.4	M16x1.5	10	42.7	20.0	19	0.10
A-0516-FM4L	05	5/16	7.9	M16x1.5	10	47.5	20.0	19	0.13
A-0616-FM4L	06	3/8	9.5	M16x1.5	10	46.8	20.0	19	0.14
A-0618-FM4L	06	3/8	9.5	M18x1.5	12	46.8	19.5	22	0.15
A-0822-FM4L	08	1/2	12.7	M22x1.5	15	55.0	21.0	27	0.24
A-1026-FM4L	10	5/8	15.9	M26x1.5	18	65.3	24.0	32	0.37
A-1230-FM4L	12	3/4	19.0	M30x2	22	69.4	32.0	36	0.54
A-1636-FM4L	16	1	25.4	M36x2	28	91.4	32.0	41	0.74
A-2045-FM4L	20	1 1/4	31.8	M45x2	35	135.5	45.0	50	1.32
A-2452-FM4L	24	1 1/2	38.1	M52x2	42	114.1	47.0	60	1.93

Because we continually examine ways to improve our products, we reserve the right to alter specifications or discontinue products without prior notice.

Two-Piece Fittings - A Series



HOSES

ONE-PIECE
B SERIES

ONE-PIECE
D SERIES

ONE-PIECE
F & P SERIES

TWO-PIECE FERRULES
(A & PFR SERIES)

TWO-PIECE INSERTS
(A SERIES)

TWO-PIECE INTERLOCK
FERRULES & INSERTS
(X & Z SERIES)

QUICK
RELEASE

ASSEMBLY
EQUIPMENT

TECHNICAL
INFORMATION

Inserts for two-piece fittings – International End Inserts

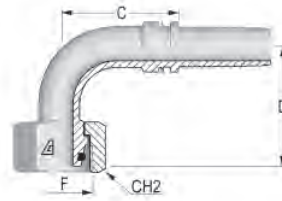

90° Metric O-Ring Female Swivel 24° Seat – DIN 3865 Light

Part Number	Dash Size	Hose ID Size		F Thread Size (mm) x TP (mm)	Tube OD (mm)	C Cut-Off Factor (mm)	D Drop (mm)	Hex Dia. CH2 (mm)	Weight (lbs/each)
		(in)	(mm)						
A-0414-FM9L	04	1/4	6.4	M14x1.5	8	28.3	32.5	17	0.09
A-0416-FM9L	04	1/4	6.4	M16x1.5	10	28.3	32.5	19	0.10
A-0516-FM9L	05	5/16	7.9	M16x1.5	10	33.7	38.0	19	0.13
A-0616-FM9L	06	3/8	9.5	M16x1.5	10	32.8	38.0	19	0.14
A-0618-FM9L	06	3/8	9.5	M18x1.5	12	32.8	39.0	22	0.15
A-0622-FM9L	06	3/8	9.5	M22x1.5	15	35.8	38.5	27	0.18
A-0822-FM9L	08	1/2	12.7	M22x1.5	15	39.8	40.5	27	0.24
A-1026-FM9L	10	5/8	15.9	M26x1.5	18	51.4	48.0	32	0.39
A-1230-FM9L	12	3/4	19.0	M30x2	22	52.1	59.0	36	0.57
A-1636-FM9L	16	1	25.4	M36x2	28	77.6	68.0	41	0.86
A-2045-FM9L	20	1 1/4	31.8	M45x2	35	90.5	89.0	50	1.54
A-2452-FM9L	24	1 1/2	38.1	M52x2	42	104.0	100.0	60	2.34

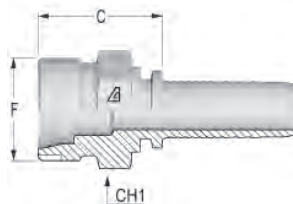

Metric Male 24° Seat – DIN 3853 Heavy

Part Number	Dash Size	Hose ID Size		F Thread Size (mm) x TP (mm)	Tube OD (mm)	C Cut-Off Factor (mm)	Hex Dia. CH1 (mm)	Weight (lbs/each)
		(in)	(mm)					
A-0414-MMSH	04	1/4	6.4	M14x1.5	6	24.3	17	0.06
A-0416-MMSH	04	1/4	6.4	M16x1.5	8	24.3	17	0.06
A-0418-MMSH	04	1/4	6.4	M18x1.5	10	25.3	19	0.07
A-0520-MMSH	05	5/16	7.9	M20x1.5	12	25.3	22	0.10
A-0620-MMSH	06	3/8	9.5	M20x1.5	12	25.3	22	0.11
A-0622-MMSH	06	3/8	9.5	M22x1.5	14	27.3	22	0.12
A-0824-MMSH	08	1/2	12.7	M24x1.5	16	29.1	24	0.15
A-1030-MMSH	10	5/8	15.9	M30x2	20	33.1	32	0.26
A-1236-MMSH	12	3/4	19.0	M36x2	25	37.6	36	0.41
A-1642-MMSH	16	1	25.4	M42x2	30	42.4	46	0.76
A-2052-MMSH	20	1 1/4	31.8	M52x2	38	48.0	55	1.15

Because we continually examine ways to improve our products, we reserve the right to alter specifications or discontinue products without prior notice.



Inserts for two-piece fittings – International End Inserts

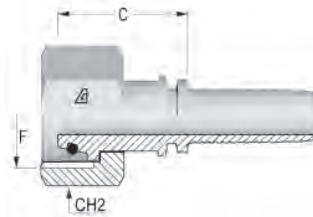

Metric O-Ring Female Swivel 24° Seat – DIN 3865 Heavy

Part Number	Dash Size	Hose ID Size		F Thread Size (mm) x TP (mm)	Tube OD (mm)	C Cut-Off Factor (mm)	Hex Dia. CH2 (mm)	Weight (lbs/each)
		(in)	(mm)					
A-0414-FMOH	04	1/4	6.4	M14x1.5	6	26.4	17	0.07
A-0416-FMOH	04	1/4	6.4	M16x1.5	8	27.7	19	0.08
A-0418-FMOH	04	1/4	6.4	M18x1.5	10	27.6	22	0.12
A-0518-FMOH	05	5/16	7.9	M18x1.5	10	27.6	22	0.12
A-0520-FMOH	05	5/16	7.9	M20x1.5	12	27.6	24	0.12
A-0620-FMOH	06	3/8	9.5	M20x1.5	12	27.6	24	0.14
A-0622-FMOH	06	3/8	9.5	M22x1.5	14	31.1	27	0.20
A-0824-FMOH	08	1/2	12.7	M24x1.5	16	31.7	30	0.26
A-1030-FMOH	10	5/8	15.9	M30x2	20	36.5	36	0.41
A-1236-FMOH	12	3/4	19.0	M36x2	25	40.2	46	0.75
A-1642-FMOH	16	1	25.4	M42x2	30	43.1	50	0.97
A-2052-FMOH	20	1 1/4	31.8	M52x2	38	48.1	60	1.54

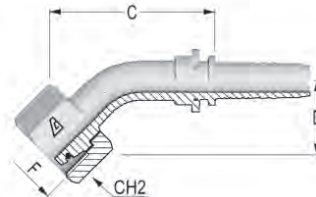

45° Metric O-Ring Female Swivel 24° Seat – DIN 3865 Heavy

Part Number	Dash Size	Hose ID Size		F Thread Size (mm) x TP (mm)	Tube OD (mm)	C Cut-Off Factor (mm)	D Drop (mm)	Hex Dia. CH2 (mm)	Weight (lbs/each)
		(in)	(mm)						
A-0414-FM4H	04	1/4	6.4	M14x1.5	6	45.6	16.0	17	0.09
A-0418-FM4H	04	1/4	6.4	M18x1.5	10	43.5	19.0	22	0.12
A-0520-FM4H	05	5/16	7.9	M20x1.5	12	48.1	21.0	24	0.18
A-0620-FM4H	06	3/8	9.5	M20x1.5	12	50.6	20.0	24	0.17
A-0622-FM4H	06	3/8	9.5	M22x1.5	14	52.9	21.0	27	0.23
A-0824-FM4H	08	1/2	12.7	M24x1.5	16	55.8	21.5	30	0.29
A-1030-FM4H	10	5/8	15.9	M30x2	20	66.3	30.0	36	0.50
A-1236-FM4H	12	3/4	19.0	M36x2	25	69.5	33.0	46	0.87
A-1642-FM4H	16	1	25.4	M42x2	30	110.3	40.5	50	1.31
A-2052-FM4H	20	1 1/4	31.8	M52x2	38	109.0	45.0	60	1.90

Because we continually examine ways to improve our products, we reserve the right to alter specifications or discontinue products without prior notice.

Two-Piece Fittings - A Series



HOSES

ONE-PIECE
B SERIES

ONE-PIECE
D SERIES

ONE-PIECE
F & P SERIES

TWO-PIECE FERRULES
(A & PFR SERIES)

TWO-PIECE INSERTS
(A SERIES)

TWO-PIECE INTERLOCK
FERRULES & INSERTS
(X & Z SERIES)

QUICK
RELEASE

ASSEMBLY
EQUIPMENT

TECHNICAL
INFORMATION

Inserts for two-piece fittings – International End Configurations

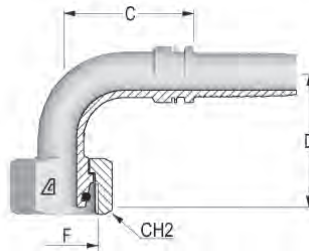

90° Metric O-Ring Female Swivel 24° Seat – DIN 3865 Heavy

Part Number	Dash Size	Hose ID Size		F Thread Size (mm) x TP (mm)	Tube OD (mm)	C Cut-Off Factor (mm)	D Drop (mm)	Hex Dia. CH2 (mm)	Weight (lbs/each)
		(in)	(mm)						
A-0414-FM9H	04	1/4	6.4	M14x1.5	6	27.3	33.0	17	0.11
A-0418-FM9H	04	1/4	6.4	M18x1.5	10	26.8	34.0	22	0.13
A-0520-FM9H	05	5/16	7.9	M20x1.5	12	33.2	39.0	24	0.19
A-0620-FM9H	06	3/8	9.5	M20x1.5	12	34.3	38.5	24	0.18
A-0622-FM9H	06	3/8	9.5	M22x1.5	14	34.3	40.5	27	0.24
A-0822-FM9H	08	1/2	12.7	M22x1.5	14	40.0	45.0	27	0.29
A-0824-FM9H	08	1/2	12.7	M24x1.5	16	39.8	41.5	30	0.31
A-1030-FM9H	10	5/8	15.9	M30x2	20	47.9	55.0	36	0.52
A-1236-FM9H	12	3/4	19.0	M36x2	25	50.6	59.5	46	0.88
A-1642-FM9H	16	1	25.4	M42x2	30	75.6	79.0	50	1.38
A-2052-FM9H	20	1 1/4	31.8	M52x2	38	94.0	92.0	60	2.09

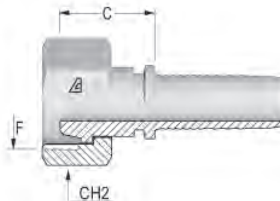

Metric Swivel Female 60° Cone – DIN 3863

Part Number	Dash Size	Hose ID Size		F Thread Size (mm) x TP (mm)	C Cut-Off Factor (mm)	Hex Dia. CH2 (mm)	Weight (lbs/each)
		(in)	(mm)				
A-1230-FM6S	12	3/4	19.0	M30x1.5	22.2	36	0.31
A-1638-FM6S	16	1	25.4	M38x1.5	28.0	46	0.49

Because we continually examine ways to improve our products, we reserve the right to alter specifications or discontinue products without prior notice.



Inserts for two-piece fittings – International End Inserts

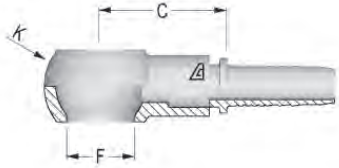

Metric Banjo

Part NuMBANer	Dash Size	Hose ID Size		F Thread Size (mm) x TP (mm)	C Cut-Off Factor (mm)	K (mm)	Weight (lbs/each)
		(in)	(mm)				
A-0412-MBAN	04	1/4	6.4	M12x1.5	28.5	20	0.05
A-0414-MBAN	04	1/4	6.4	M14x1.5	27.5	24	0.06
A-0512-MBAN	05	5/16	7.9	M12x1.5	28.5	24	0.06
A-0514-MBAN	05	5/16	7.9	M14x1.5	27.5	24	0.07
A-0614-MBAN	06	3/8	9.5	M14x1.5	27.5	24	0.08
A-0616-MBAN	06	3/8	9.5	M16x1.5	30.5	28	0.11
A-0618-MBAN	06	3/8	9.5	M18x1.5	31.5	32	0.15
A-0818-MBAN	08	1/2	12.7	M18x1.5	32.0	32	0.17
A-0822-MBAN	08	1/2	12.7	M22x1.5	35.0	39	0.19
A-1022-MBAN	10	5/8	15.9	M22x1.5	35.0	39	0.28
A-1226-MBAN	12	3/4	19.0	M26x1.5	38.5	46	0.42
A-1630-MBAN	16	1	25.4	M30x1.5	42.5	54	0.94

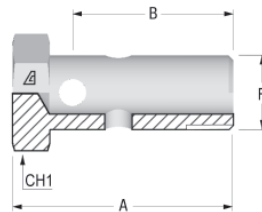

Metric Bolt

Part Number	F Thread Size (in) -TPI	A (mm)	B (mm)	CH1 (mm)	Weight (lbs/each)
MBOLT-10	10x1.5	24	19	14	0.03
MBOLT-12	12x1.5	29	24	17	0.06
MBOLT-14	14x1.5	34	28	19	0.08
MBOLT-16	16x1.5	41	34	22	0.13
MBOLT-18	18x1.5	44	37	24	0.15
MBOLT-22	22x1.5	48	41	27	0.23
MBOLT-26	26x1.5	52	42	32	0.38
MBOLT-30	30x1.5	62	51	38	0.53

Because we continually examine ways to improve our products, we reserve the right to alter specifications or discontinue products without prior notice.

Two-Piece Fittings - A Series



HOSES

ONE-PIECE
B SERIES

ONE-PIECE
D SERIES

ONE-PIECE
F & P SERIES

TWO-PIECE FERRULES
(A & PFR SERIES)

TWO-PIECE INSERTS
(A SERIES)

TWO-PIECE INTERLOCK
FERRULES & INSERTS
(X & Z SERIES)

QUICK
RELEASE

ASSEMBLY
EQUIPMENT

TECHNICAL
INFORMATION

Inserts for two-piece fittings – International End Inserts

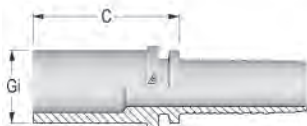

For Nuts & Cutting Rings,
please refer to pages 214-216.

Metric Straight Standpipe

Part Number	Dash Size	Hose ID Size		GI Tube OD (mm)	C Cut-Off Factor (mm)	Weight (lbs/each)
		(in)	(mm)			
A-0306-MSPS	03	3/16	4.8	6	27.8	0.02
A-0308-MSPS	03	3/16	4.8	8	29.8	0.03
A-0406-MSPS	04	1/4	6.4	6	28.3	0.02
A-0408-MSPS	04	1/4	6.4	8	30.2	0.03
A-0410-MSPS	04	1/4	6.4	10	32.2	0.04
A-0412-MSPS	04	1/4	6.4	12	31.2	0.06
A-0510-MSPS	05	5/16	7.9	10	30.2	0.04
A-0512-MSPS	05	5/16	7.9	12	32.7	0.06
A-0610-MSPS	06	3/8	9.5	10	30.3	0.04
A-0612-MSPS	06	3/8	9.5	12	29.3	0.05
A-0614-MSPS	06	3/8	9.5	14	35.8	0.09
A-0615-MSPS	06	3/8	9.5	15	34.8	0.09
A-0812-MSPS	08	1/2	12.7	12	32.1	0.10
A-0814-MSPS	08	1/2	12.7	14	36.1	0.10
A-0815-MSPS	08	1/2	12.7	15	32.1	0.10
A-0816-MSPS	08	1/2	12.7	16	37.1	0.12
A-0818-MSPS	08	1/2	12.7	18	36.0	0.12
A-1018-MSPS	10	5/8	15.9	18	34.2	0.14
A-1020-MSPS	10	5/8	15.9	20	44.2	0.20
A-1022-MSPS	10	5/8	15.9	22	37.2	0.18
A-1220-MSPS	12	3/4	19.0	20	45.5	0.20
A-1222-MSPS	12	3/4	19.0	22	36.5	0.21
A-1225-MSPS	12	3/4	19.0	25	48.5	0.77
A-1625-MSPS	16	1	25.4	25	51.4	0.41
A-1628-MSPS	16	1	25.4	28	40.4	0.43
A-1630-MSPS	16	1	25.4	30	54.4	0.23
A-1638-MSPS	16	1	25.4	38	60.4	0.11
A-2030-MSPS	20	1 1/4	31.8	30	56.0	0.66
A-2035-MSPS	20	1 1/4	31.8	35	48.0	0.60
A-2038-MSPS	20	1 1/4	31.8	38	62.0	0.83
A-2438-MSPS	24	1 1/2	38.1	38	62.0	1.03
A-2442-MSPS	24	1 1/2	38.1	42	52.0	0.86

Because we continually examine ways to improve our products, we reserve the right to alter specifications or discontinue products without prior notice.



Inserts for two-piece fittings – International End Inserts

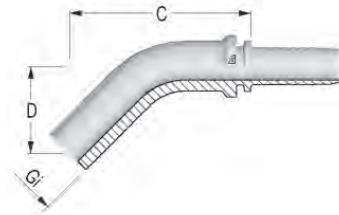

For Nuts & Cutting Rings,
please refer to pages 214-216.

45° Metric Bent Tube Standpipe – DIN 2353

Part Number	Dash Size	Hose ID Size		GI Tube OD (mm)	C Cut-Off Factor (mm)	D Drop (mm)	Weight (lbs/each)
		(in)	(mm)				
A-0406-MSP4	04	1/4	6.4	6	50.1	28.0	0.06
A-0408-MSP4	04	1/4	6.4	8	43.2	23.0	0.05
A-0410-MSP4	04	1/4	6.4	10	48.0	24.0	0.04
A-0610-MSP4	06	3/8	9.5	10	48.5	24.0	0.11
A-0612-MSP4	06	3/8	9.5	12	55.5	28.0	0.11
A-0814-MSP4	08	1/2	12.7	14	56.0	28.5	0.22
A-0815-MSP4	08	1/2	12.7	15	62.6	28.5	0.17
A-0816-MSP4	08	1/2	12.7	16	63.3	32.0	0.18
A-0818-MSP4	08	1/2	12.7	18	72.0	30.5	0.20
A-1018-MSP4	10	5/8	15.9	18	64.0	32.0	0.20
A-1020-MSP4	10	5/8	15.9	20	72.0	37.0	0.20
A-1022-MSP4	10	5/8	15.9	22	72.0	37.0	0.25
A-1220-MSP4	12	3/4	19.0	20	85.0	37.0	0.22
A-1222-MSP4	12	3/4	19.0	22	74.3	37.0	0.27
A-1225-MSP4	12	3/4	19.0	25	83.0	44.0	0.40
A-1625-MSP4	16	1	25.4	25	102.3	55.0	0.44

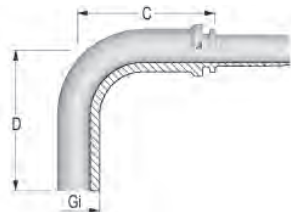

For Nuts & Cutting Rings,
please refer to pages 214-216.

90° Metric Bent Tube Standpipe – DIN 2353

Part Number	Dash Size	Hose ID Size		GI Tube OD (mm)	C Cut-Off Factor (mm)	D Drop (mm)	Weight (lbs/each)
		(in)	(mm)				
A-0406-MSP9	04	1/4	6.4	6	25.4	36	0.04
A-0408-MSP9	04	1/4	6.4	8	25.9	44	0.06
A-0410-MSP9	04	1/4	6.4	10	30.6	42	0.08
A-0610-MSP9	06	3/8	9.5	10	30.7	42	0.08
A-0612-MSP9	06	3/8	9.5	12	35.0	50	0.13

continued on
the next page

Because we continually examine ways to improve our products, we reserve the right to alter specifications or discontinue products without prior notice.

Two-Piece Fittings - A, MTN Series



Nuts and Cutting Rings for DIN 24° Tube Connections

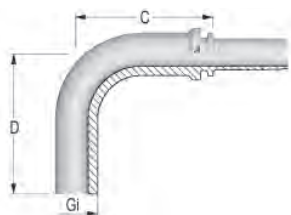

For Nuts & Cutting Rings,
please refer to pages 214-216.

(continued)

90° Metric Bent Tube Standpipe – DIN 2353

Part Number	Dash Size	Hose ID Size		GI Tube OD (mm)	C Cut-Off Factor (mm)	D Drop (mm)	Weight (lbs/each)
		(in)	(mm)				
A-0814-MSP9	08	1/2	12.7	14	39.0	52.0	0.16
A-0815-MSP9	08	1/2	12.7	15	44.7	57.0	0.17
A-0816-MSP9	08	1/2	12.7	16	43.7	64.0	0.24
A-0818-MSP9	08	1/2	12.7	18	58.1	59.0	0.37
A-1018-MSP9	10	5/8	15.9	18	52.2	58.0	0.27
A-1020-MSP9	10	5/8	15.9	20	62.6	70.0	0.45
A-1022-MSP9	10	5/8	15.9	22	49.4	64.0	0.35
A-1220-MSP9	12	3/4	19.0	20	63.4	70.0	0.38
A-1222-MSP9	12	3/4	19.0	22	53.1	67.5	0.44
A-1225-MSP9	12	3/4	19.0	25	63.2	85.0	0.77
A-1625-MSP9	16	1	25.4	25	73.1	98.5	0.82
A-1628-MSP9	16	1	25.4	28	73.1	89.5	0.88
A-1630-MSP9	16	1	25.4	30	73.1	102.5	1.47

Nuts and Cutting Rings for DIN 24° Tube Connections

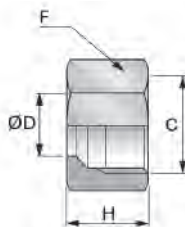

Nut DIN 24° Light Series

Part Number	OD (mm)	C (mm)	F (mm)	H (mm)	Weight (lbs/each)
MTN-6L12X1.5	6	M12X1.5	14	14.5	0.02
MTN-8L14X1.5	8	M14X1.5	17	14.5	0.03
MTN-10L16X1.5	10	M16X1.5	19	15.5	0.04
MTN-12L18X1.5	12	M18X1.5	22	15.5	0.05
MTN-15L22X1.5	15	M22X1.5	27	17.0	0.09
MTN-18L26X1.5	18	M26X1.5	32	18.0	0.13
MTN-22L30X2	22	M30X2	36	20.0	0.17
MTN-28L36X2	28	M36X2	41	21.0	0.20
MTN-35L45X2	35	M45X2	50	24.0	0.30
MTN-42L52X2	42	M52X2	60	24.0	0.48

Because we continually examine ways to improve our products, we reserve the right to alter specifications or discontinue products without prior notice.



HOSES
ONE-PIECE B SERIES
ONE-PIECE D SERIES
ONE-PIECE F & P SERIES
TWO-PIECE FERRULES (A & PFR SERIES)
TWO-PIECE INSERTS (A SERIES)
TWO-PIECE INTERLOCK FERRULES & INSERTS (X & Z SERIES)
QUICK RELEASE
ASSEMBLY EQUIPMENT
TECHNICAL INFORMATION

Nuts and Cutting Rings for DIN 24° Tube Connections

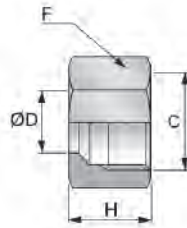

Nut DIN 24° Heavy Series

Part Number	OD (mm)	C (mm)	F (mm)	H (mm)	Weight (lbs/each)
MTN-6H14X1.5	6	M14X1.5	17	16.5	0.04
MTN-8H16X1.5	8	M16X1.5	19	16.5	0.04
MTN-10H18X1.5	10	M18X1.5	22	17.5	0.07
MTN-12H20X1.5	12	M20X1.5	24	17.5	0.08
MTN-14H22X1.5	14	M22X1.5	27	20.5	0.11
MTN-16H24X1.5	16	M24X1.5	30	20.5	0.14
MTN-20H30X2	20	M30X2	36	24.0	0.22
MTN-25H36X2	25	M36X2	46	27.0	0.44
MTN-30H42X2	30	M42X2	50	29.0	0.49
MTN-38H52X2	38	M52X2	60	32.5	0.68

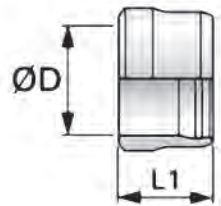

Double Cutting Ring DIN 24° Light Series

Part Number	OD (mm)	L1 (mm)	Weight (lbs/each)
MBS-06LH	6	9.5	0.01
MBS-08LH	8	10.0	0.01
MBS-10LH	10	10.5	0.01
MBS-12LH	12	10.5	0.01
MBS-15L	15	10.5	0.01
MBS-18L	18	10.5	0.02
MBS-22L	22	11.0	0.02
MBS-28L	28	11.0	0.03
MBS-35L	35	13.5	0.05
MBS-42L	42	13.5	0.05

Because we continually examine ways to improve our products, we reserve the right to alter specifications or discontinue products without prior notice.

Two-Piece Fittings - A, MBS Series



HOSES

ONE-PIECE
B SERIES

ONE-PIECE
D SERIES

ONE-PIECE
F & P SERIES

TWO-PIECE FERRULES
(A & PFR SERIES)

TWO-PIECE INSERTS
(A SERIES)

TWO-PIECE INTERLOCK
FERRULES & INSERTS
(X & Z SERIES)

QUICK
RELEASE

ASSEMBLY
EQUIPMENT

TECHNICAL
INFORMATION

Inserts for two-piece fittings – International End Inserts

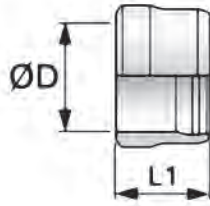

Double Cutting Ring DIN 24° Heavy Series

Part Number	OD (mm)	L1 (mm)	Weight (lbs/each)
MBS-14H	14	10.5	0.01
MBS-16H	16	10.5	0.02
MBS-20H	20	13.0	0.03
MBS-25H	25	13.5	0.04
MBS-30H	30	13.5	0.04
MBS-38H	38	13.5	0.05

Inserts for two-piece fittings – International End Inserts

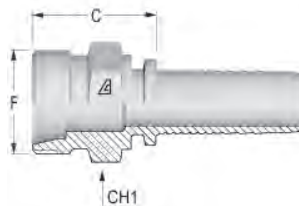

Metric Male French Type (GAZ)

Part Number	Dash Size	Hose ID Size		F Thread Size (mm) x TP (mm)	Tube OD (mm)	C Cut-Off Factor (mm)	CH1 (mm)	Weight (lbs/each)
		(in)	(mm)					
A-0520-MMFR	05	5/16	7.9	M20x1.5	13.25	25.3	22	0.08
A-0620-MMFR	06	3/8	9.5	M20x1.5	13.25	25.3	22	0.10
A-0824-MMFR	08	1/2	12.7	M24x1.5	16.75	27.1	24	0.15
A-1030-MMFR	10	5/8	15.9	M30x1.5	21.25	31.1	30	0.23
A-1236-MMFR	12	3/4	19.0	M36x1.5	26.75	33.6	36	0.34

Because we continually examine ways to improve our products, we reserve the right to alter specifications or discontinue products without prior notice.



Inserts for two-piece fittings – International End Inserts

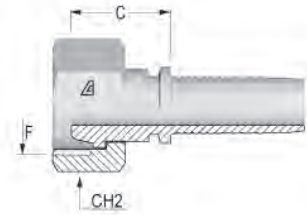

Metric Female French Type (GAZ)

Part Number	Dash Size	Hose ID Size		F Thread Size (mm) x TP (mm)	Tube OD (mm)	C Cut-Off Factor (mm)	Hex Dia. CH2 (mm)	Weight (lbs/each)
		(in)	(mm)					
A-0420-FMFS	04	1/4	6.4	M20x1.5	13.25	23.8	24	0.13
A-0520-FMFS	05	5/16	7.9	M20x1.5	13.25	23.8	24	0.14
A-0620-FMFS	06	3/8	9.5	M20x1.5	13.25	23.8	24	0.14
A-0624-FMFS	06	3/8	9.5	M24x1.5	16.75	26.8	30	0.15
A-0824-FMFS	08	1/2	12.7	M24x1.5	16.75	26.8	30	0.22
A-0830-FMFS	08	1/2	12.7	M30x1.5	21.25	25.6	36	0.33
A-1030-FMFS	10	5/8	15.9	M30x1.5	21.25	26.6	36	0.40
A-1236-FMFS	12	3/4	19.0	M36x1.5	26.75	27.0	42	0.46

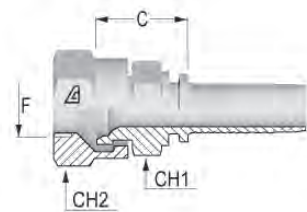

JIS Female Swivel 30° Seat – B 8363 Type F

Part Number	Dash Size	Hose ID Size		F Thread		C Cut-Off Factor (mm)	Hex Dia. CH1 (mm)	Hex Dia. CH2 (mm)	Weight (lbs/each)
		(in)	(mm)	Dash Size	Size (in) - TPI				
A-0404-FJIS	04	1/4	6.4	04	1/4-19	20.8	17	19	0.09
A-0606-FJIS	06	3/8	9.5	06	3/8-19	21.8	19	22	0.13
A-0808-FJIS	08	1/2	12.7	08	1/2-14	23.6	22	27	0.20
A-1212-FJIS	12	3/4	19.0	12	3/4-14	27.1	30	36	0.41
A-1616-FJIS	16	1	25.4	16	1-11	32.9	36	41	0.62
A-2020-FJIS	20	1 1/4	31.8	20	1 1/4-11	39.5	46	50	1.19
A-2424-FJIS	24	1 1/2	38.1	24	1 1/2-11	41.5	50	55	1.48

Because we continually examine ways to improve our products, we reserve the right to alter specifications or discontinue products without prior notice.

Two-Piece Fittings - A Series



HOSES

ONE-PIECE
B SERIES

ONE-PIECE
D SERIES

ONE-PIECE
F & P SERIES

TWO-PIECE FERRULES
(A & PFR SERIES)

TWO-PIECE INSERTS
(A SERIES)

TWO-PIECE INTERLOCK
FERRULES & INSERTS
(X & Z SERIES)

QUICK
RELEASE

ASSEMBLY
EQUIPMENT

TECHNICAL
INFORMATION

Inserts for two-piece fittings – International End Inserts

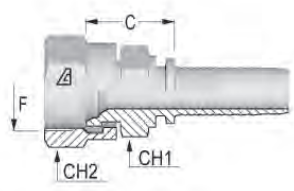

Komatsu Female

Part Number	Dash Size	Hose ID Size		F Thread Size (mm) x TP (mm)	C Cut-Off Factor (mm)	Hex Dia. CH1 (mm)	Hex Dia. CH2 (mm)	Weight (lbs/each)
		(in)	(mm)					
A-0414-FKOS	04	1/4	6.4	M14x1.5	20.7	17	19	0.09
A-0618-FKOS	06	3/8	9.5	M18x1.5	22.8	19	22	0.13
A-0822-FKOS	08	1/2	12.7	M22x1.5	24.6	22	27	0.20
A-1024-FKOS	10	5/8	15.9	M24x1.5	29.2	30	32	0.40
A-1230-FKOS	12	3/4	19.0	M30x1.5	27.5	30	36	0.44
A-1633-FKOS	16	1	25.4	M33x1.5	35.7	36	41	0.77
A-2036-FKOS	20	1 1/4	31.8	M36x1.5	43.5	46	46	1.29
A-2442-FKOS	24	1 1/2	38.1	M42x1.5	44.0	55	55	1.93

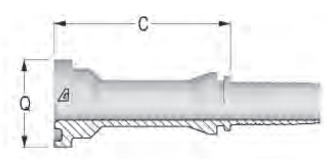

Komatsu Straight O-Ring Flange

Part Number	Dash Size	Hose ID Size		Q Flange		C Cut-Off Factor (mm)	Weight (lbs/each)
		(in)	(mm)	(in)	(mm)		
A-1010-KFLS	10	5/8	15.9	1.34	34	46.6	0.30

Because we continually examine ways to improve our products, we reserve the right to alter specifications or discontinue products without prior notice.

Inserts for two-piece fittings – International End Inserts

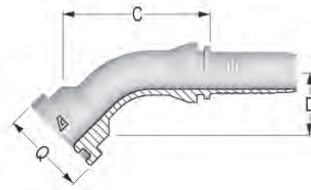

Komatsu 45° O-Ring Flange

Part Number	Dash Size	Hose ID Size		Q Flange		C Cut-Off Factor (mm)	D Drop (mm)	Weight (lbs/each)
		(in)	(mm)	(in)	(mm)			
A-1010-KF45	10	5/8	15.9	1.34	34	59	23	0.33

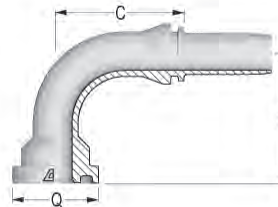

Komatsu 90° O-Ring Flange

Part Number	Dash Size	Hose ID Size		Q Flange		C Cut-Off Factor (mm)	D Drop (mm)	Weight (lbs/each)
		(in)	(mm)	(in)	(mm)			
A-1010-KF90	10	5/8	15.9	1.34	34	51	51	0.39

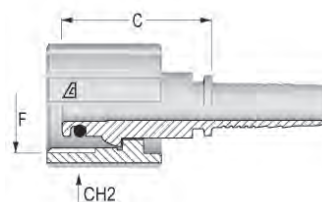

Pressure Wash Female (Type K)

Part Number	Dash Size	Hose ID Size		F Thread Size (mm) x TP (mm)	C Cut-Off Factor (mm)	Hex Dia. 2 (mm)	Weight (lbs/each)
		(in)	(mm)				
A-0422-FPWS	04	1/4	6.4	M22x1.5	34	27	0.15
A-0522-FPWS	05	5/16	7.9	M22x1.5	34	27	0.15
A-0622-FPWS	06	3/8	9.5	M22x1.5	34	27	0.16

Because we continually examine ways to improve our products, we reserve the right to alter specifications or discontinue products without prior notice.

Fitting Configuration Chart



HOSES
ONE-PIECE B SERIES
ONE-PIECE D SERIES
ONE-PIECE F & P SERIES
TWO-PIECE FERRULES (A & PFR SERIES)
TWO-PIECE INSERTS (A SERIES)
TWO-PIECE INTERLOCK FERRULES & INSERTS (X & Z SERIES)
QUICK RELEASE
ASSEMBLY EQUIPMENT
TECHNICAL INFORMATION

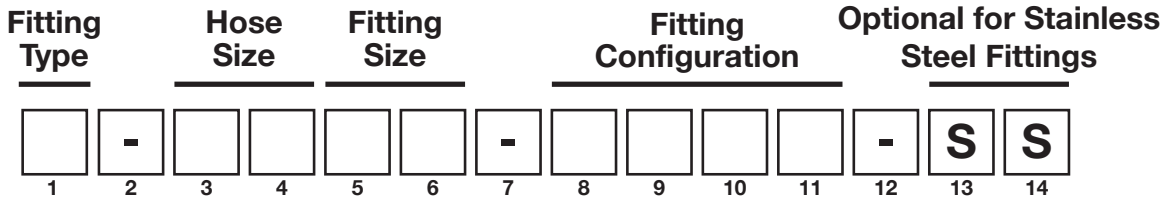

Fitting Type	Hose Size	Fitting Size
1-Piece Series		
B	-02 or 1/8"	-02 or 1/8"
D	-03 or 3/16"	-03 or 3/16"
F	-04 or 1/4"	-04 or 1/4"
P	-05 or 5/16"	-05 or 5/16"
2-Piece Series		
A	-06 or 3/8"	-06 or 3/8"
X	-08 or 1/2"	-08 or 1/2"
Z	-10 or 5/8"	-10 or 5/8"
V	-12 or 3/4"	-12 or 3/4"
	-14 or 7/8"	-14 or 7/8"
	-16 or 1"	-16 or 1"
	-20 or 1 1/4"	-20 or 1 1/4"
	-24 or 1 1/2"	-24 or 1 1/2"
	-32 or 2"	-32 or 2"
	-40 or 2 1/2"	-40 or 2 1/2"
	-48 or 3"	-48 or 3"

TYPE	SUFFIX	DESCRIPTION
NPTF	FNPR	Female National Pipe Rigid
	FPMS	Female Pipe Straight Mechanical Swivel
	FNPS	Female National Pipe Swivel
	MNPT	Male Pipe NPTF
	MNPS	Male National Pipe Swivel
	MPS9	Male Pipe Swivel 90 Degree
JIC	FJSH	Female JIC Single Hex Swivel
	FJDH	Female JIC Double Hex Swivel
	FJ45	Female JIC 45 Degree Swivel
	FJ9L	Female JIC 90 Degree Long Swivel
	FJ9M	Female JIC 90 Degree Medium Swivel
	FJ9S	Female JIC 90 Degree Short Swivel
	MJIC	Male JIC
	SAE	FSAE
FAE4		Female SAE 45 Degree Swivel
FAE9		Female SAE 90 Degree Swivel
MORB		Male O-Ring Boss
MOBS		Male O-Ring Boss Swivel
MBS9		Male O-Ring Boss Swivel 90 Degree
MIFL		Male Inverted Flare
MIF4		Male Inverted Flare 45 Degree
MIF9		Male Inverted Flare 90 Degree
MSAE		Male SAE
ORFS	F0FS	Female O-Ring Face Seal Swivel
	F045	Female O-Ring Face Seal 45 Degree Swivel
	F09L	Female O-Ring Face Seal 90 Degree Long Swivel
	F09M	Female O-Ring Face Seal 90 Degree Medium Swivel
	F09S	Female O-Ring Face Seal 90 Degree Short Swivel
	MOFS	Male O-Ring Face Seal
SAE Flange Code 61	C61S	Code 61 Flange Straight
	C612	Code 61 Flange 22.5 Degree
	C613	Code 61 Flange 30 Degree
	C614	Code 61 Flange 45 Degree
	C616	Code 61 Flange 60 Degree
	C619	Code 61 Flange 90 Degree
SAE Flange Code 62	C62S	Code 62 Flange Straight
	C624	Code 62 Flange 45 Degree
	C629	Code 62 Flange 90 Degree

Fitting Configuration Chart – Fitting Type Explanation

B Series – One-piece non-skive crimp fitting for all braided hoses up to 1" ID.

D Series – One-piece non-skive crimp fitting for wire braided hoses above 1" ID and 4 wire spiral hose Alfabiotech 3000 1 1/4" ID thru 2" ID and Alfabiotech 4000 3/8" ID thru 1 1/4" ID.

F Series – One-piece non-skive crimp fitting for Alfabiotech 4000 2" ID, Alfabiotech 5000 3/4" ID thru 2" ID and Alfabiotech 6000 3/4" thru 1 1/4".

P Series – One-piece non-skive crimp fitting for use with Piranhaflex PF321TC hose only.

A Series – Two-piece insert for all wire and textile braided hoses, thermoplastic hose, Flexor 4 and PTFE hose 3/16" thru 2" and Alfabiotech 3000 1 1/4" and 1 1/2", Alfabiotech 4000 3/8" thru 1 1/4" along with some smaller ID spiral wire reinforced hoses.

X Series – Two-piece Interlock insert for spiral wire reinforced hoses. Requires both internal and external skiving and a XF1 or XF2 Interlock ferrule to perform properly.

Z Series – Two-piece Interlock insert for Alfatech 6000 (AT6K) in 2" size only. Requires both internal and external skiving and a ZF1 Interlock ferrule to perform properly.

V Series – Two-piece insert for Flexor Rig/Alfabiotech 2000, 2 1/2" and 3" ID size only. Requires a VS4 skive ferrule to perform properly.

Because we continually examine ways to improve our products, we reserve the right to alter specifications or discontinue products without prior notice.



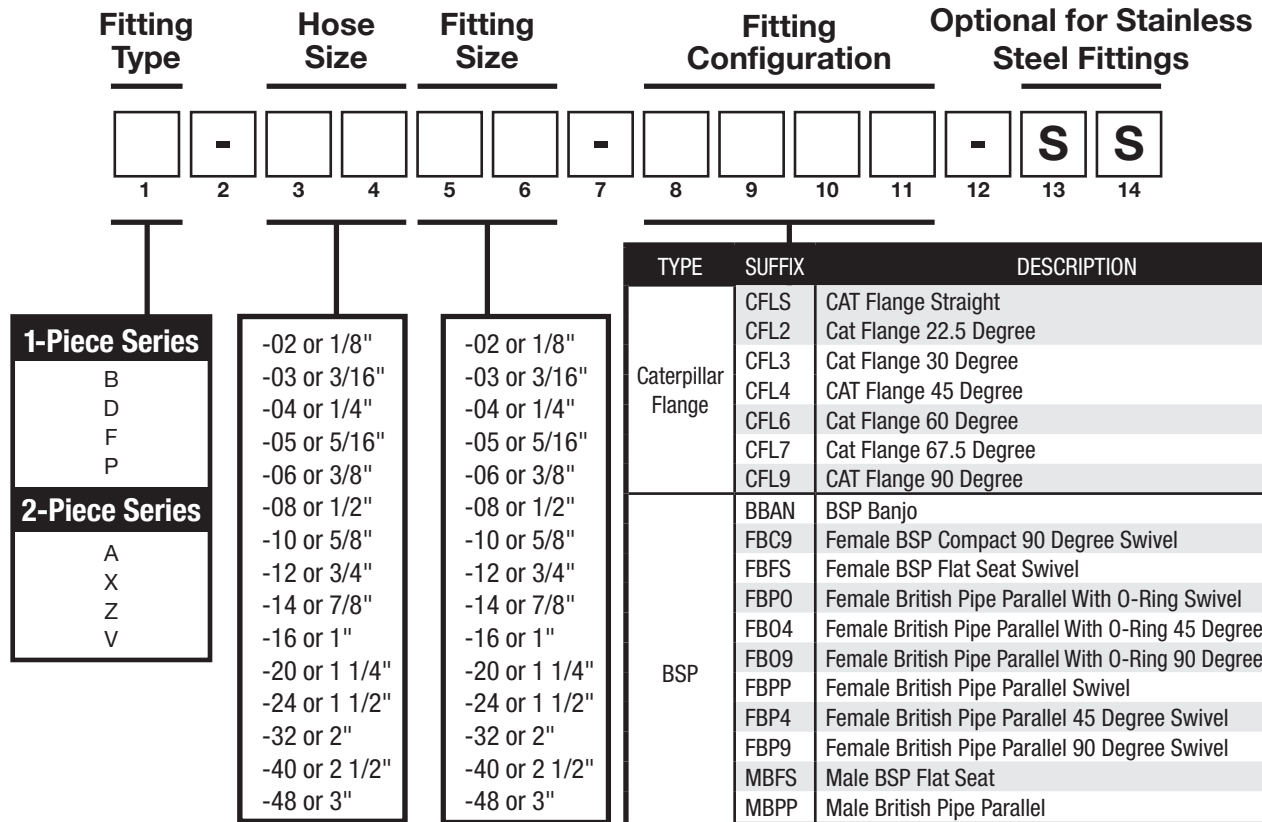

Fitting Configuration Chart – Fitting Type Explanation

B Series – One-piece non-skive crimp fitting for all braided hoses up to 1" ID.

D Series – One-piece non-skive crimp fitting for wire braided hoses above 1" ID and 4 wire spiral hose Alfabiotech 3000 1 ¼" ID thru 2" ID and Alfabiotech 4000 ¾" ID thru 1 ¼" ID.

F Series – One-piece non-skive crimp fitting for Alfabiotech 4000 2" ID, Alfabiotech 5000 ¾" ID thru 2" ID and Alfabiotech 6000 ¾" thru 1 ¼".

P Series – One-piece non-skive crimp fitting for use with Piranhaflex PF321TC hose only.

A Series – Two-piece insert for all wire and textile braided hoses, thermoplastic hose, Flexor 4 and PTFE hose ¾" thru 2" and Alfabiotech 3000 1 ¼" and 1 ½", Alfabiotech 4000 ¾" thru 1 ¼" along with some smaller ID spiral wire reinforced hoses.

X Series – Two-piece Interlock insert for spiral wire reinforced hoses. Requires both internal and external skiving and a XF1 or XF2 Interlock ferrule to perform properly.

Z Series – Two-piece Interlock insert for Alfatech 6000 (AT6K) in 2" size only. Requires both internal and external skiving and a ZF1 Interlock ferrule to perform properly.

V Series – Two-piece insert for Flexor Rig/Alfabiotech 2000, 2 ½" and 3" ID size only. Requires a VS4 skive ferrule to perform properly.

Because we continually examine ways to improve our products, we reserve the right to alter specifications or discontinue products without prior notice.

HOSES
ONE-PIECE B SERIES
ONE-PIECE D SERIES
ONE-PIECE F SERIES
TWO-PIECE FERRULES (A & PFR SERIES)
TWO-PIECE INSERTS (A SERIES)
TWO-PIECE INTERLOCK FERRULES & INSERTS (X & Z SERIES)
QUICK RELEASE
ASSEMBLY EQUIPMENT
TECHNICAL INFORMATION

Hose Ferrule Part Number Configurator



HOSES
ONE-PIECE B SERIES
ONE-PIECE D SERIES
ONE-PIECE F & P SERIES
TWO-PIECE FERRULES (A & PFR SERIES)
TWO-PIECE INSERTS (A SERIES)
TWO-PIECE INTERLOCK FERRULES & INSERTS (X & Z SERIES)
QUICK RELEASE
ASSEMBLY EQUIPMENT
TECHNICAL INFORMATION

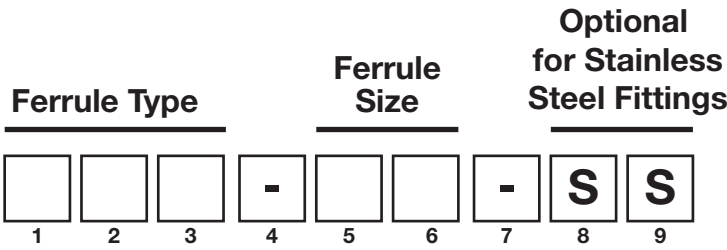

No Skive Ferrule
AF1
AF2
AF4
AFT
AFX
PFR - Piranhaflex
PFR3 - Piranhaflex
PFR7 - Piranhaflex
Skive Ferrule
AS4
VS4
Interlock Ferrule
XF1
XF2
ZF1

- 02 or 1/8"
- 03 or 3/16"
- 04 or 1/4"
- 05 or 5/16"
- 06 or 3/8"
- 08 or 1/2"
- 10 or 5/8"
- 12 or 3/4"
- 14 or 7/8"
- 16 or 1"
- 20 or 1 1/4"
- 24 or 1 1/2"
- 32 or 2"
- 40 or 2 1/2"
- 48 or 3"

Fitting Configuration Chart – Ferrule Type Explanation

AF1 – Two piece non-skive ferrule for use with “A” insert on single wire braided and compact hydraulic hoses, Flexor 1 (TR1MT, T1SNTT), Flexopak 2 (TF2MT, TF2ST, TF2LT), Alfatech 3000 (AT3KMT, AT3KST), Alfajet 210 (TAJ3BK/BU) and Alfajet 400 (TAJ5BK/BU).

AF2 – Two piece non-skive ferrule for use with “A” insert on double wire braided hydraulic hoses, Flexor 2 (TR2MT, T2SNTT).

AF4 – Two piece non-skive ferrule for use with “A” insert on spiral wire reinforced hoses Alfabiotech ABT3K and ABT4K.

AFT – Two piece non-skive stainless steel ferrule for use with “A” insert on stainless braided PTFE hose (TR14TB).

AFX – Two piece non-skive ferrule for use with “A” insert on textile braided hydraulic hose Flexor 5 (TR5) and Flexor 4 (TR4XF).

PFR, PFR3 and PFR7 – Piranhaflex – Two piece non-skive ferrule for use with “A” insert on all Piranhaflex hydraulic hoses, R7, R8 and R18 styles.

AS4 – Two piece skive ferrule for use with “A” insert on spiral reinforced hoses Alfabiotech ABT4K, ABT5K, ABT6K.

VS4 – Two piece skive ferrule for use with “V” insert on Flexor Rig-40 and 48.

XF1 – Two piece Interlock ferrule for use with “X” Interlock insert on spiral wire reinforced hoses. Requires internal and external skiving.

XF2 – Two piece Interlock ferrule for use with “X” Interlock insert on spiral wire reinforced hoses. Requires internal and external skiving.

ZF1 – Two piece Interlock ferrule for use with “Z” Interlock insert on Aflatech 6000-32, 2” size. Requires internal and external skiving.

Because we continually examine ways to improve our products, we reserve the right to alter specifications or discontinue products without prior notice.



Ferrule Selection Chart

Interlock Ferrule For Interlock Fittings

Series	Description	Page No.	Size	-06	-08	-10	-12	-16	-20	-24	-32	-40	-48
			DIN	10	12	16	19	25	32	38	51	63	76
			(in)	3/8	1/2	5/8	3/4	1	1 1/4	1 1/2	2	2 1/2	3
ABT3K	ALFABIOTECH 3000 MINETUFF	30											ZF1
ABT4K	ALFABIOTECH 4000 MINETUFF	31								XF2	XF2		
ABT5K	ALFABIOTECH 5000 MINETUFF	32				XF2	XF2	XF2	XF2	XF1	XF1	XF1	
ABT5KST	ALFABIOTECH 5000 SUPERTUFF	39				XF2	XF2	XF2	XF2	XF1	XF1		
ABT6K	ALFABIOTECH 6000 MINETUFF	34				XF1	XF2	XF2	XF1	XF1	ZF1		
ABT6KST	ALFABIOTECH 6000 SUPERTUFF	40			XF2	XF1	XF2	XF2	XF1	XF1	ZF1		
ABTP5K	ALFABIOTECH 5500 MINETUFF	33				XF2	XF2						
AT10KOC	OILWELL CEMENTING SUPERTUFF	71									ZF1		
FLEXOR RIG	FLEXOR RIG MINETUFF ROTARY	69						XF2	XF2	XF1	XF1	XF1	
WB10	WATERBLAST MINETUFF	72			XF2		XF2	XF2					
WB15	WATERBLAST MINETUFF	73			WF9		WF9						
WB20	WATERBLAST MINETUFF	74			WF8								

HOSES

ONE-PIECE B SERIES

ONE-PIECE D SERIES

ONE-PIECE F SERIES

TWO-PIECE FERRULES (A & PFR SERIES)

TWO-PIECE INSERTS (A SERIES)

TWO-PIECE INTERLOCK FERRULES & INSERTS (X & Z SERIES)

QUICK RELEASE

ASSEMBLY EQUIPMENT

TECHNICAL INFORMATION

Because we continually examine ways to improve our products, we reserve the right to alter specifications or discontinue products without prior notice.



Two-Piece X & Z Series Fittings Index

Interlock Ferrules – Skive



XF1 227



XF2 227



ZF1 227

- HOSES
- ONE-PIECE B SERIES
- ONE-PIECE D SERIES
- ONE-PIECE F & P SERIES
- TWO-PIECE FERRULES (A & PFR SERIES)
- TWO-PIECE INSERTS (A SERIES)
- TWO-PIECE INTERLOCK FERRULES & INSERTS (X & Z SERIES)
- QUICK RELEASE
- ASSEMBLY EQUIPMENT
- TECHNICAL INFORMATION

Because we continually examine ways to improve our products, we reserve the right to alter specifications or discontinue products without prior notice.



Two-Piece X Series Interlock Fittings Index – US End Configurations

NPTF

 NPTF Male 60° Seat Interlock 228

JIC

 JIC Male 37° Interlock..... 228

 JIC Swivel Female 37° Seat Interlock 229

 45° JIC Swivel Female 37° Seat Interlock 229

 90° JIC Swivel Female 37° Seat Interlock 229

ORFS

 ORFS Straight Female - Double Hex Interlock 230

 45° ORFS Female Interlock..... 230

 90° ORFS Female Interlock..... 230

SAE Flange Code 61

 O-Ring Flange SAE J518 Code 61 Interlock 231

 45° O-Ring Flange SAE J518 Code 61 Interlock 231

 90° O-Ring Flange SAE J518 Code 61 Interlock 232

SAE Flange Code 62

 O-Ring Flange SAE J518 Code 62 Interlock 232

 45° O-Ring Flange SAE J518 Code 62 Interlock 233

 90° O-Ring Flange SAE J518 Code 62 Interlock 233

Caterpillar Flange

 O-Ring SuperCAT 6000 PSI Flange Interlock 234

 45° O-Ring SuperCAT 6000 PSI Flange Interlock 234

 90° O-Ring SuperCAT 6000 PSI Flange Interlock 235





Because we continually examine ways to improve our products, we reserve the right to alter specifications or discontinue products without prior notice.

Two-Piece X & Z Series Interlock Fittings Index – International End Configurations





HOSES
ONE-PIECE B SERIES
ONE-PIECE D SERIES
ONE-PIECE F & P SERIES
TWO-PIECE FERRULES (A & PFR SERIES)
TWO-PIECE INSERTS (A SERIES)
TWO-PIECE INTERLOCK FERRULES & INSERTS (X & Z SERIES)
QUICK RELEASE
ASSEMBLY EQUIPMENT
TECHNICAL INFORMATION

Interlock Inserts – International End Configurations

BSP



-  **BSP Male Parallel 60° Seat Interlock**..... 236
-  **BSP/JIS Male Tapered Interlock** 236
-  **BSP/JIC Swivel Female 60° Cone Interlock**..... 236
-  **45° BSP Swivel Female 60° Cone Interlock**..... 237
-  **90° BSP Swivel Female 60° Cone Interlock**..... 237

Metric

-  **Metric Male 24° Seat Interlock – DIN 3861 Heavy** 238
-  **Metric Female O-Ring Swivel Interlock – DIN 3865 Heavy** 238
-  **45° Metric Female O-Ring Swivel Interlock – DIN 3865 Heavy** 239
-  **90° Metric Female O-Ring Swivel Interlock – DIN 3865 Heavy** 239

Interlock Inserts – International End Configurations



Hammer Unions

-  **Male Hammer Union Fig. 1502 Integral Fitting with Lug Nut**..... 235, 241
-  **Female Hammer Union Fig. 1502 Integral Fitting with Rubber Ring** 235, 241

API

-  **API Male NPT** 241

SAE Flange Code 62

-  **O-Ring Flange SAE J518 Code 62 Interlock**..... 240
-  **45° O-Ring Flange SAE J518 Code 62 Interlock**..... 240
-  **90° O-Ring Flange SAE J518 Code 62 Interlock**..... 240

Because we continually examine ways to improve our products, we reserve the right to alter specifications or discontinue products without prior notice.

Interlock Skive Ferrules

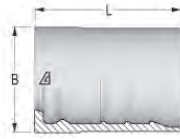

XF1

Part Number	Dash Size	Hose ID Size		B OD (mm)	L Length (mm)	Weight (lbs/each)
		(in)	(mm)			
XF1-10	10	5/8	15.9	35.5	57.5	0.50
XF1-20	20	1 1/4	31.8	64.0	88.1	1.40
XF1-24	24	1 1/2	38.1	69.5	94.1	1.90
XF1-32	32	2	50.8	88.0	99.0	3.24
XF1-40	40	2 1/2	63.0	102.0	110.0	3.95



XF2

Part Number	Dash Size	Hose ID Size		B OD (mm)	L Length (mm)	Weight (lbs/each)
		(in)	(mm)			
XF2-06	06	3/8	9.5	27	49.0	0.19
XF2-08	08	1/2	12.7	30	52.5	0.25
XF2-10	10	5/8	15.9	34	57.5	0.30
XF2-12	12	3/4	19.0	38	60.1	0.32
XF2-16	16	1	25.4	46	74.6	0.59
XF2-20	20	1 1/4	31.8	55	88.1	1.10
XF2-24	24	1 1/2	38.1	62	94.1	1.29
XF2-32	32	2	50.8	78	99.1	1.98

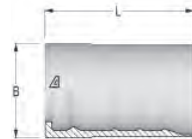

ZF1

Part Number	Dash Size	Hose ID Size		B OD (mm)	L Length (mm)	Weight (lbs/each)
		(in)	(mm)			
ZF1-32	32	2	50.8	88	108.2	3.30
ZF1-40	40	2 1/2	63.0	109	134.0	3.78
ZF1-48	48	3	76.0	122	149.0	4.21

Because we continually examine ways to improve our products, we reserve the right to alter specifications or discontinue products without prior notice.

Two-Piece Fittings - X Series



Interlock Inserts – US End Configurations

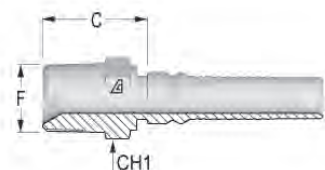

NPTF Male 60° Seat Interlock

Part Number	Dash Size	Hose ID Size		F Thread		C Cut-Off Factor (mm)	Hex Dia. CH1 (mm)	Weight (lbs/each)
		(in)	(mm)	Dash Size	Size (in) - TPI			
X-0606-MNPT	06	3/8	9.5	06	3/8-19	26.0	19	0.17
X-0808-MNPT	08	1/2	12.7	08	1/2-14	32.0	22	0.21
X-1012-MNPT	10	5/8	15.9	12	3/4-14	32.0	27	0.28
X-1212-MNPT	12	3/4	19.0	12	3/4-14	32.0	27	0.35
X-1616-MNPT	16	1	25.4	16	1-11 1/2	41.0	36	0.70
X-2020-MNPT	20	1 1/4	31.8	20	1 1/4-11 1/2	46.2	46	1.21
X-2424-MNPT	24	1 1/2	38.1	24	1 1/2-11 1/2	47.5	50	1.68
X-3232-MNPT	32	2	50.8	32	2-11 1/2	51.0	65	2.48

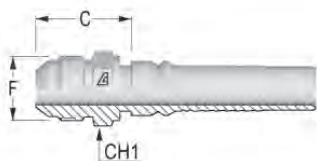

JIC Male 37° Interlock

Part Number	Dash Size	Hose ID Size		F Thread		C Cut-Off Factor (mm)	Hex Dia. CH1 (mm)	Weight (lbs/each)
		(in)	(mm)	Dash Size	Size (in) - TPI			
X-0808-MJIC	08	1/2	12.7	08	3/4-16	28.0	19	0.34
X-1212-MJIC	12	3/4	19.0	12	1 1/16-12	39.1	36	0.43
X-1616-MJIC	16	1	25.4	16	1 5/16-12	40.1	36	0.50
X-2020-MJIC	20	1 1/4	31.8	20	1 5/8-12	45.5	46	0.68
X-2424-MJIC	24	1 1/2	38.1	24	1 7/8-12	51.0	50	1.20
X-3232-MJIC	32	2	50.8	32	2 1/2-12	58.9	65	1.76

Because we continually examine ways to improve our products, we reserve the right to alter specifications or discontinue products without prior notice.



HOSES
ONE-PIECE B SERIES
ONE-PIECE D SERIES
ONE-PIECE F & P SERIES
TWO-PIECE FERRULES (A & PFR SERIES)
TWO-PIECE INSERTS (A SERIES)
TWO-PIECE INTERLOCK FERRULES & INSERTS (X & Z SERIES)
QUICK RELEASE
ASSEMBLY EQUIPMENT
TECHNICAL INFORMATION

Interlock Inserts – US End Configurations

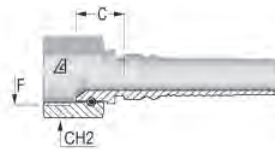

JIC Swivel Female 37° Seat Interlock

Part Number	Dash Size	Hose ID Size		F Thread		C Cut-Off Factor (mm)	Hex Dia. CH2 (mm)	Weight (lbs/each)
		(in)	(mm)	Dash Size	Size (in) - TPI			
X-1212-FJSH	12	3/4	19.0	12	1 1/16-12	18.7	32	0.41
X-1616-FJSH	16	1	25.4	16	1 5/16-12	22.5	38	0.66
X-2020-FJSH	20	1 1/4	31.8	20	1 5/8-12	25.7	50	1.24
X-2424-FJSH	24	1 1/2	38.1	24	1 7/8-12	29.0	55	1.72
X-3232-FJSH	32	2	50.8	32	2 1/2-12	34.0	70	2.80

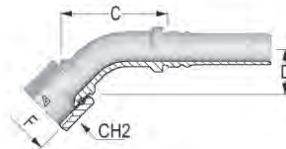

45° JIC Swivel Female 37° Seat Interlock

Part Number	Dash Size	Hose ID Size		F Thread		C Cut-Off Factor (mm)	D Drop (mm)	Hex Dia. CH2 (mm)	Weight (lbs/each)
		(in)	(mm)	Dash Size	Size (in) - TPI				
X-1212-FJ45	12	3/4	19.0	12	1 1/16-12	66.0	27.5	32	0.69
X-1616-FJ45	16	1	25.4	16	1 5/16-12	79.5	31.0	38	1.24
X-2020-FJ45	20	1 1/4	31.8	20	1 5/8-12	93.7	37.0	50	1.73
X-2424-FJ45	24	1 1/2	38.1	24	1 7/8-12	107.0	38.0	55	2.78
X-3232-FJ45	32	2	50.8	32	2 1/2-12	148.0	51.5	70	4.96

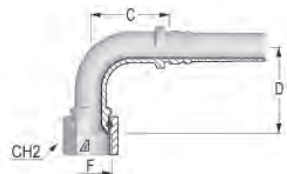

90° JIC Swivel Female 37° Seat Interlock

Part Number	Dash Size	Hose ID Size		F Thread		C Cut-Off Factor (mm)	D Drop (mm)	Hex Dia. CH2 (mm)	Weight (lbs/each)
		(in)	(mm)	Dash Size	Size (in) - TPI				
X-1212-FJ9M	12	3/4	19.0	12	1 1/16-12	52.0	57.0	32	0.66
X-1616-FJ9M	16	1	25.4	16	1 5/16-12	70.0	67.0	38	0.94
X-2020-FJ9M	20	1 1/4	31.8	20	1 5/8-12	79.2	78.0	50	2.10
X-2424-FJ9M	24	1 1/2	38.1	24	1 7/8-12	94.5	92.0	55	3.09
X-3232-FJ9M	32	2	50.8	32	2 1/2-12	146.0	120.5	70	5.51

Because we continually examine ways to improve our products, we reserve the right to alter specifications or discontinue products without prior notice.

Two-Piece Fittings - X Series



Interlock Inserts – US End Configurations

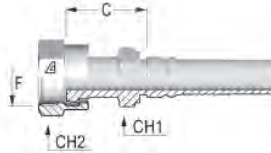

ORFS Straight Female – Double Hex Interlock

Part Number	Dash Size	Hose ID Size		F Thread		C Cut-Off Factor (mm)	Hex Dia. CH1 (mm)	Hex Dia. CH2 (mm)	Weight (lbs/each)
		(in)	(mm)	Dash Size	Size (in) - TPI				
X-1012-FOFS	10	5/8	15.9	12	1 3/16-12	40.0	30	36	0.28
X-1212-FOFS	12	3/4	19.0	12	1 3/16-12	40.0	30	36	0.59
X-1216-FOFS	12	3/4	19.0	16	1 7/16-12	43.0	36	41	0.82
X-1616-FOFS	16	1	25.4	16	1 7/16-12	47.0	36	41	0.90
X-1620-FOFS	16	1	25.4	20	1 11/16-12	49.0	46	50	1.28
X-2020-FOFS	20	1 1/4	31.8	20	1 11/16-12	47.2	46	50	1.46
X-2424-FOFS	24	1 1/2	38.1	24	2-12	52.0	50	60	1.70

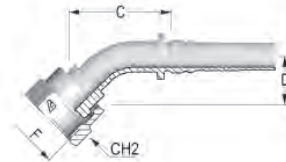

45° ORFS Female Interlock

Part Number	Dash Size	Hose ID Size		F Thread		C Cut-Off Factor (mm)	D Drop (mm)	Hex Dia. CH2 (mm)	Weight (lbs/each)
		(in)	(mm)	Dash Size	Size (in) - TPI				
X-1212-F045	12	3/4	19.0	12	1 3/16-12	77.0	26	36	0.22
X-1216-F045	12	3/4	19.0	16	1 7/16-12	68.4	28	41	0.79
X-1616-F045	16	1	25.4	16	1 7/16-12	75.0	28	41	1.10
X-1620-F045	16	1	25.4	20	1 11/16-12	83.4	28	50	1.35
X-2020-F045	20	1 1/4	31.8	20	1 11/16-12	100.7	33	50	1.89
X-2424-F045	24	1 1/2	38.1	24	2-12	107.0	36.5	60	2.15

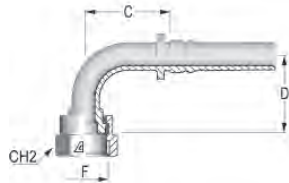

90° ORFS Female Interlock

Part Number	Dash Size	Hose ID Size		F Thread		C Cut-Off Factor (mm)	D Drop (mm)	Hex Dia. CH2 (mm)	Weight (lbs/each)
		(in)	(mm)	Dash Size	Size (in) - TPI				
X-1012-F09M	10	5/8	15.9	12	1 3/16-12	48.1	58	36	0.23
X-1212-F09M	12	3/4	19.0	12	1 3/16-12	64.2	58	36	0.86
X-1216-F09M	12	3/4	19.0	16	1 7/16-12	66.2	58	41	1.10
X-1616-F09M	16	1	25.4	16	1 7/16-12	75.2	66	41	1.20
X-1620-F09M	16	1	25.4	20	1 11/16-12	73.2	66	50	1.47
X-2020-F09M	20	1 1/4	31.8	20	1 11/16-12	91.7	81	50	1.98
X-2424-F09M	24	1 1/2	38.1	24	2-12	99.0	84	60	2.25

Because we continually examine ways to improve our products, we reserve the right to alter specifications or discontinue products without prior notice.



HOSES
 ONE-PIECE B SERIES
 ONE-PIECE D SERIES
 ONE-PIECE F & P SERIES
 TWO-PIECE FERRULES (A & PFR SERIES)
 TWO-PIECE INSERTS (A SERIES)
 TWO-PIECE INTERLOCK FERRULES & INSERTS (X & Z SERIES)
 QUICK RELEASE
 ASSEMBLY EQUIPMENT
 TECHNICAL INFORMATION

Interlock Inserts – US End Configurations

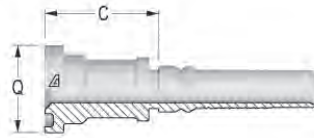

O-Ring Flange SAE J518 Code 61 Interlock

Part Number	Dash Size	Hose ID Size		Q Flange		C Cut-Off Factor (mm)	Max Working Pressure (psi)	Weight (lbs/each)
		(in)	(mm)	(in)	(mm)			
X-0808-C61S	08	1/2	12.7	1.19	30.2	39.0	5000	0.32
X-1012-C61S	10	5/8	15.9	1.50	38.1	40.0	5000	0.44
X-1212-C61S	12	3/4	19.0	1.50	38.1	40.0	5000	0.61
X-1216-C61S	12	3/4	19.0	1.75	44.5	48.0	5000	0.66
X-1616-C61S	16	1	25.4	1.75	44.5	49.0	5000	0.93
X-1620-C61S	16	1	25.4	2.00	50.8	51.5	4000	0.95
X-2020-C61S	20	1 1/4	31.8	2.00	50.8	52.7	4000	1.32
X-2024-C61S	20	1 1/4	31.8	2.38	60.3	55.7	3000	1.59
X-2424-C61S	24	1 1/2	38.1	2.38	60.3	56.0	3000	1.81
X-2432-C61S	24	1 1/2	38.1	2.81	71.4	67.5	3000	2.65
X-3232-C61S	32	2	50.8	2.81	71.4	69.0	3000	2.87

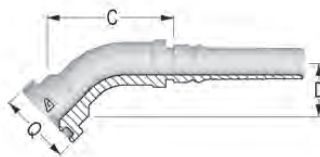

45° O-Ring Flange SAE J518 Code 61 Interlock

Part Number	Dash Size	Hose ID Size		Q Flange		C Cut-Off Factor (mm)	D Drop (mm)	Max Working Pressure (psi)	Weight (lbs/each)
		(in)	(mm)	(in)	(mm)				
X-0808-C614	08	1/2	12.7	1.19	30.2	51.0	22.0	5000	0.39
X-1212-C614	12	3/4	19.0	1.50	38.1	68.0	25.0	5000	0.63
X-1216-C614	12	3/4	19.0	1.75	44.5	92.5	28.0	5000	0.89
X-1616-C614	16	1	25.4	1.75	44.5	82.5	29.0	5000	0.99
X-1620-C614	16	1	25.4	2.00	50.8	95.6	30.0	4000	1.41
X-2020-C614	20	1 1/4	31.8	2.00	50.8	100.9	32.5	4000	0.88
X-2024-C614	20	1 1/4	31.8	2.38	60.3	92.8	40.0	3000	1.76
X-2424-C614	24	1 1/2	38.1	2.38	60.3	103.7	43.0	3000	2.65
X-2432-C614	24	1 1/2	38.1	2.81	71.4	132.7	56.5	3000	2.87
X-3232-C614	32	2	50.8	2.81	71.4	138.1	54.0	3000	3.53

Because we continually examine ways to improve our products, we reserve the right to alter specifications or discontinue products without prior notice.

Two-Piece Fittings - X Series



Interlock Inserts – US End Configurations

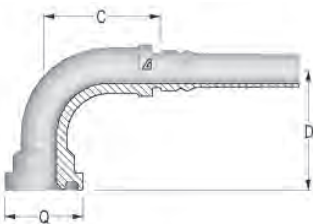

90° O-Ring Flange SAE J518 Code 61 Interlock

Part Number	Dash Size	Hose ID Size		Q Flange		C Cut-Off Factor (mm)	D Drop (mm)	Max WP (psi)	Weight (lbs/each)
		(in)	(mm)	(in)	(mm)				
X-1012-C619	10	5/8	15.9	1.50	38.1	53.0	55	5000	0.61
X-1212-C619	12	3/4	19.0	1.50	38.1	58.0	55	5000	0.74
X-1216-C619	12	3/4	19.0	1.75	44.5	64.0	59	5000	0.85
X-1616-C619	16	1	25.4	1.75	44.5	72.2	64	5000	1.10
X-1620-C619	16	1	25.4	2.00	50.8	70.2	69	4000	1.22
X-2020-C619	20	1 1/4	31.8	2.00	50.8	86.2	81	4000	1.65
X-2024-C619	20	1 1/4	31.8	2.38	60.3	81.2	85	3000	2.21
X-2424-C619	24	1 1/2	38.1	2.38	60.3	95.5	93	3000	2.51
X-2432-C619	24	1 1/2	38.1	2.81	71.4	130.3	97	3000	3.26
X-3232-C619	32	2	50.8	2.81	71.4	134.4	130	3000	4.41

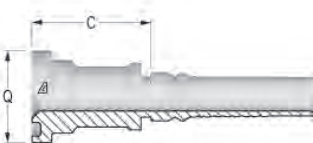

O-Ring Flange SAE J518 Code 62 Interlock

Part Number	Dash Size	Hose ID Size		Q Flange		C Cut-Off Factor (mm)	Max WP (psi)	Weight (lbs/each)
		(in)	(mm)	(in)	(mm)			
X-1012-C62S	10	5/8	15.9	1.63	41.3	50.0	6000	0.55
X-1212-C62S	12	3/4	19.0	1.63	41.3	50.0	6000	0.64
X-1216-C62S	12	3/4	19.0	1.88	47.6	53.0	6000	0.79
X-1616-C62S	16	1	25.4	1.88	47.6	54.0	6000	0.99
X-1620-C62S	16	1	25.4	2.13	54.0	61.0	6000	1.25
X-2020-C62S	20	1 1/4	31.8	2.13	54.0	62.2	6000	1.48
X-2024-C62S	20	1 1/4	31.8	2.50	63.5	68.2	6000	1.85
X-2424-C62S	24	1 1/2	38.1	2.50	63.5	68.5	6000	2.21
X-2432-C62S	24	1 1/2	38.1	3.13	79.4	80.5	6000	3.75
X-3232-C62S	32	2	50.8	3.13	79.4	87.0	6000	3.11

Because we continually examine ways to improve our products, we reserve the right to alter specifications or discontinue products without prior notice.



HOSES
ONE-PIECE B SERIES
ONE-PIECE D SERIES
ONE-PIECE F & P SERIES
TWO-PIECE FERRULES (A & PFR SERIES)
TWO-PIECE INSERTS (A SERIES)
TWO-PIECE INTERLOCK FERRULES & INSERTS (X & Z SERIES)
QUICK RELEASE
ASSEMBLY EQUIPMENT
TECHNICAL INFORMATION

Interlock Inserts – US End Configurations

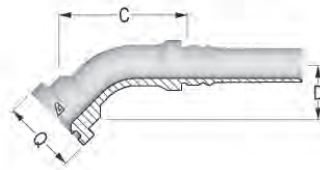

45° O-Ring Flange SAE J518 Code 62 Interlock

Part Number	Dash Size	Hose ID Size		Q Flange		C Cut-Off Factor (mm)	D Drop (mm)	Max WP (psi)	Weight (lbs/each)
		(in)	(mm)	(in)	(mm)				
X-1212-C624	12	3/4	19.0	1.63	41.3	72.1	30.0	6000	0.74
X-1216-C624	12	3/4	19.0	1.88	47.6	76.8	33.0	6000	1.05
X-1616-C624	16	1	25.4	1.88	47.6	94.8	35.0	6000	1.12
X-1620-C624	16	1	25.4	2.13	54.0	91.3	44.0	6000	1.43
X-2020-C624	20	1 1/4	31.8	2.13	54.0	102.0	39.5	6000	2.08
X-2024-C624	20	1 1/4	31.8	2.50	63.5	111.7	48.0	6000	1.98
X-2424-C624	24	1 1/2	38.1	2.50	63.5	136.3	48.0	6000	2.67
X-2432-C624	24	1 1/2	38.1	3.13	79.4	129.1	55.0	6000	3.97
X-3232-C624	32	2	50.8	3.13	79.4	160.6	63.0	6000	5.14

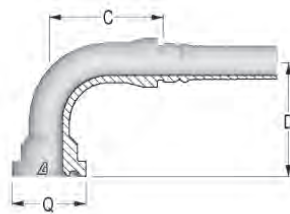

90° O-Ring Flange SAE J518 Code 62 Interlock

Part Number	Dash Size	Hose ID Size		Q Flange		C Cut-Off Factor (mm)	D Drop (mm)	Max WP (psi)	Weight (lbs/each)
		(in)	(mm)	(in)	(mm)				
X-1008-C629	10	5/8	15.9	1.25	31.8	47.0	55.0	6000	0.63
X-1012-C629	10	5/8	15.9	1.63	41.3	47.0	55.0	6000	0.64
X-1212-C629	12	3/4	19.0	1.63	41.3	61.2	64.0	6000	0.80
X-1216-C629	12	3/4	19.0	1.88	47.6	61.2	66.0	6000	1.06
X-1616-C629	16	1	25.4	1.88	47.6	70.4	74.0	6000	1.54
X-1620-C629	16	1	25.4	2.13	54.0	77.2	80.0	6000	1.62
X-2020-C629	20	1 1/4	31.8	2.13	54.0	88.2	91.0	6000	2.47
X-2024-C629	20	1 1/4	31.8	2.50	63.5	92.9	103.5	6000	3.08
X-2424-C629	24	1 1/2	38.1	2.50	63.5	106.3	109.0	6000	2.69
X-2432-C629	24	1 1/2	38.1	3.13	79.4	106.5	121.5	6000	4.41
X-3232-C629	32	2	50.8	3.13	79.4	149.0	138.5	6000	6.17

Because we continually examine ways to improve our products, we reserve the right to alter specifications or discontinue products without prior notice.

Two-Piece Fittings - X Series



Interlock Inserts – US End Configurations

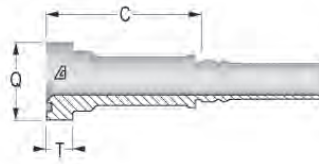

O-Ring SuperCAT 6000 PSI Flange Interlock

Part Number	Dash Size	Hose ID Size		Q Flange		C Cut-Off Factor (mm)	T (mm)	Weight (lbs/each)
		(in)	(mm)	(in)	(mm)			
X-1212-CFLS	12	3/4	19.0	1.63	41.3	82.0	14.3	0.64
X-1216-CFLS	12	3/4	19.0	1.88	47.6	82.0	14.3	0.79
X-1616-CFLS	16	1	25.4	1.88	47.6	90.0	14.3	0.99
X-1620-CFLS	16	1	25.4	2.13	54.0	90.0	14.3	1.25
X-2020-CFLS	20	1 1/4	31.8	2.13	54.0	86.2	14.3	1.48
X-2024-CFLS	20	1 1/4	31.8	2.50	63.5	83.2	14.3	1.85

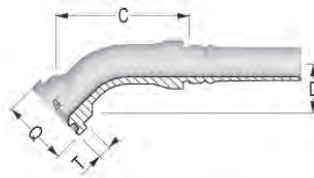

45° O-Ring SuperCAT 6000 PSI Flange Interlock

Part Number	Dash Size	Hose ID Size		Q Flange		C Cut-Off Factor (mm)	D Drop (mm)	T (mm)	Weight (lbs/each)
		(in)	(mm)	(in)	(mm)				
X-1212-CFL4	12	3/4	19.0	1.63	41.3	83	34.0	14.3	0.74
X-1216-CFL4	12	3/4	19.0	1.88	47.6	87	34.0	14.3	1.05
X-1616-CFL4	16	1	25.4	1.88	47.6	94	40.0	14.3	1.12
X-1620-CFL4	16	1	25.4	2.13	54.0	95	40.0	14.3	1.43
X-2020-CFL4	20	1 1/4	31.8	2.13	54.0	104	43.0	14.3	2.08
X-2024-CFL4	20	1 1/4	31.8	2.50	63.5	110	49.5	14.3	1.98

Because we continually examine ways to improve our products, we reserve the right to alter specifications or discontinue products without prior notice.



HOSES
ONE-PIECE B SERIES
ONE-PIECE D SERIES
ONE-PIECE F & P SERIES
TWO-PIECE FERRULES (A & PFR SERIES)
TWO-PIECE INSERTS (A SERIES)
TWO-PIECE INTERLOCK FERRULES & INSERTS (X & Z SERIES)
QUICK RELEASE
ASSEMBLY EQUIPMENT
TECHNICAL INFORMATION

Interlock Inserts – US End Configurations

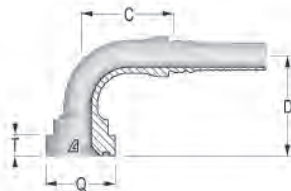

90° O-Ring SuperCAT 6000 PSI Flange Interlock

Part Number	Dash Size	Hose ID Size		Q Flange		C Cut-Off Factor (mm)	D Drop (mm)	T (mm)	Weight (lbs/each)
		(in)	(mm)	(in)	(mm)				
X-1212-CFL9	12	3/4	19.0	1.63	41.3	64	67.0	14.3	0.80
X-1216-CFL9	12	3/4	19.0	1.88	47.6	65	70.0	14.3	1.06
X-1616-CFL9	16	1	25.4	1.88	44.5	80	79.0	14.3	1.54
X-1620-CFL9	16	1	25.4	2.13	50.8	75	82.5	14.3	1.62
X-2020-CFL9	20	1 1/4	31.8	2.13	50.8	89	93.0	14.3	2.47
X-2024-CFL9	20	1 1/4	31.8	2.50	60.3	91	101.0	14.3	3.08

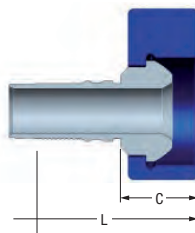

Male Hammer Union Fig. 1502 integral fitting with Lug Nut – Use with Alfabiotech 5000 and Flexor Rig hoses

Part Number	Dash Size	Hose ID (in)	Hose ID (mm)	C Cut-Off (mm)	L Overall Length (mm)	Weight (lbs/each)
X-3232-MHUN	32	2	50.8	71.0	152	14.11

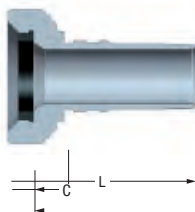

Female Hammer Union Fig. 1502 integral fitting with Rubber Ring – Use with Alfabiotech 5000 and Flexor Rig hoses

Part Number	Dash Size	Hose ID (in)	Hose ID (mm)	C Cut-Off (mm)	L Overall Length (mm)	Weight (lbs/each)
X-3232-FHUN	32	2	50.8	67.5	148.5	5.07

Because we continually examine ways to improve our products, we reserve the right to alter specifications or discontinue products without prior notice.

Two-Piece Fittings - X Series



Interlock Inserts – International End Configurations

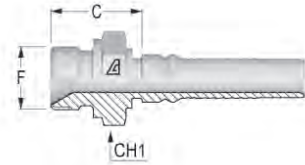

BSP Male Parallel 60° Seat Interlock

Part Number	Dash Size	Hose ID Size		F Thread		C Cut-Off Factor (mm)	Hex Dia. CH1 (mm)	Weight (lbs/each)
		(in)	(mm)	Dash Size	Size (in) - TPI			
X-1212-MBPP	12	3/4	19.0	12	3/4-14	32.0	32	0.40
X-1616-MBPP	16	1	25.4	16	1-11	38.0	41	0.75
X-1620-MBPP	16	1	25.4	20	1 1/4-11	44.0	50	1.00
X-2020-MBPP	20	1 1/4	31.8	20	1 1/4-11	44.2	50	1.27
X-2424-MBPP	24	1 1/2	38.1	24	1 1/2-11	46.5	55	1.76
X-3232-MBPP	32	2	50.8	32	2-11	52.5	70	2.80

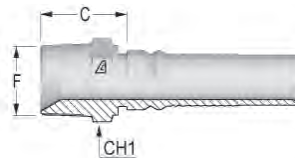

BSP/JIS Male Tapered Interlock

Part Number	Dash Size	Hose ID Size		F Thread		C Cut-Off Factor (mm)	Hex Dia. CH1 (mm)	Weight (lbs/each)
		(in)	(mm)	Dash Size	Size (in) - TPI			
X-1212-MBPT	12	3/4	19.0	12	3/4-14	32.0	27	0.34
X-1616-MBPT	16	1	25.4	16	1-11	41.0	36	0.71
X-2020-MBPT	20	1 1/4	31.8	20	1 1/4-11	46.2	46	1.28
X-2424-MBPT	24	1 1/2	38.1	24	1 1/2-11	48.0	50	1.77
X-3232-MBPT	32	2	50.8	32	2-11	53.2	65	2.77

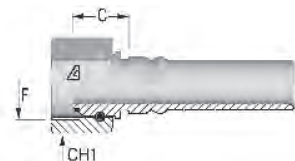

BSP/JIS Swivel Female 60° Cone Interlock

Part Number	Dash Size	Hose ID Size		F Thread		C Cut-Off Factor (mm)	Hex Dia. CH1 (mm)	Weight (lbs/each)
		(in)	(mm)	Dash Size	Size (in) - TPI			
X-0808-FBPO	08	1/2	12.7	08	1/2-14	22.5	27	0.32
X-1212-FBPO	12	3/4	19.0	12	3/4-14	25.5	32	0.42
X-1616-FBPO	16	1	25.4	16	1-11	30.2	38	0.71
X-2020-FBPO	20	1 1/4	31.8	20	1 1/4-11	33.5	50	1.29
X-2424-FBPO	24	1 1/2	38.1	24	1 1/2-11	35.0	55	1.79
X-3232-FBPO	32	2	50.8	32	2-11	33.0	70	2.77

Because we continually examine ways to improve our products, we reserve the right to alter specifications or discontinue products without prior notice.



HOSES
ONE-PIECE B SERIES
ONE-PIECE D SERIES
ONE-PIECE F & P SERIES
TWO-PIECE FERRULES (A & PFR SERIES)
TWO-PIECE INSERTS (A SERIES)
TWO-PIECE INTERLOCK FERRULES & INSERTS (X & Z SERIES)
QUICK RELEASE
ASSEMBLY EQUIPMENT
TECHNICAL INFORMATION

Interlock Inserts – International End Configurations

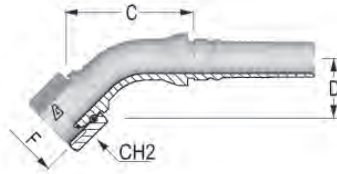

45° BSP Swivel Female 60° Cone Interlock

Part Number	Dash Size	Hose ID Size		Q Flange		C Cut-Off Factor (mm)	D Drop (mm)	Hex Dia. CH2 (mm)	Weight (lbs/each)
		(in)	(mm)	(in)	(mm)				
X-1212-FB04	12	3/4	19.0	12	3/4-14	69.0	30	32	0.71
X-1616-FB04	16	1	25.4	16	1-11	103.5	34	38	0.71
X-2020-FB04	20	1 1/4	31.8	20	1 1/4-11	97.2	40	50	1.87
X-2424-FB04	24	1 1/2	38.1	24	1 1/2-11	108.5	46	55	4.41
X-3232-FB04	32	2	50.8	32	2-11	143.0	60	70	3.97

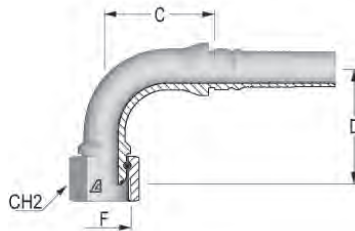

90° BSP Swivel Female 60° Cone Interlock

Part Number	Dash Size	Hose ID Size		Q Flange		C Cut-Off Factor (mm)	D Drop (mm)	Hex Dia. CH2 (mm)	Weight (lbs/each)
		(in)	(mm)	(in)	(mm)				
X-1212-FB09	12	3/4	19.0	12	3/4-14	58.0	61	32	0.79
X-1616-FB09	16	1	25.4	16	1-11	71.0	71	38	1.24
X-2020-FB09	20	1 1/4	31.8	20	1 1/4-11	79.2	83	50	2.07
X-2424-FB09	24	1 1/2	38.1	24	1 1/2-11	93.5	96	55	3.22
X-3232-FB09	32	2	50.8	32	2-11	144.0	125	70	5.51

Because we continually examine ways to improve our products, we reserve the right to alter specifications or discontinue products without prior notice.

Two-Piece Fittings - X Series



Interlock Inserts – International End Configurations

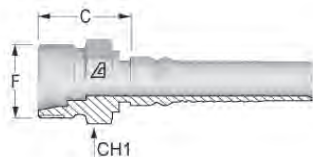

Metric Male 24° Seat Interlock – DIN 3861 Heavy

Part Number	Dash Size	Hose ID Size		F Thread Size (mm) x TP (mm)	Tube OD (mm)	C Cut-Off Factor (mm)	Hex Dia. CH1 (mm)	Weight (lbs/each)
		(in)	(mm)					
X-0824-MMSH	08	1/2	12.7	M24x1.5	16	27.0	24	0.20
X-1030-MMSH	10	5/8	15.9	M30x2	20	31.0	32	0.33
X-1236-MMSH	12	3/4	19.0	M36x2	25	35.0	36	0.47
X-1642-MMSH	16	1	25.4	M42x2	30	40.0	46	0.86
X-2052-MMSH	20	1 1/4	31.8	M52x2	38	45.2	55	1.41

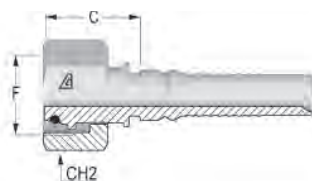

Metric Female O-Ring Swivel Interlock – DIN 3865 Heavy

Part Number	Dash Size	Hose ID Size		F Thread Size (mm) x TP (mm)	Tube OD (mm)	C Cut-Off Factor (mm)	Hex Dia. CH2 (mm)	Weight (lbs/each)
		(in)	(mm)					
X-0824-FMOH	08	1/2	12.7	M24x1.5	16	29.8	30	0.48
X-1030-FMOH	10	5/8	15.9	M30x2	20	37.6	36	0.49
X-1230-FMOH	12	3/4	19.0	M30x2	20	37.5	36	0.80
X-1236-FMOH	12	3/4	19.0	M36x2	25	41.0	46	0.84
X-1636-FMOH	16	1	25.4	M36x2	25	38.8	46	0.98
X-1642-FMOH	16	1	25.4	M42x2	30	40.7	50	1.10
X-2052-FMOH	20	1 1/4	31.8	M52x2	38	45.3	60	1.85

Because we continually examine ways to improve our products, we reserve the right to alter specifications or discontinue products without prior notice.



HOSES

ONE-PIECE B SERIES

ONE-PIECE D SERIES

ONE-PIECE F & P SERIES

TWO-PIECE FERRULES (A & PFR SERIES)

TWO-PIECE INSERTS (A SERIES)

TWO-PIECE INTERLOCK FERRULES & INSERTS (X & Z SERIES)

QUICK RELEASE

ASSEMBLY EQUIPMENT

TECHNICAL INFORMATION

Interlock Inserts – International End Configurations

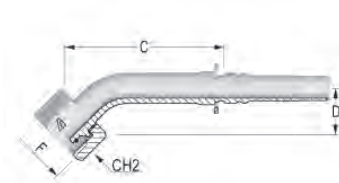

45° Metric Female O-Ring Swivel – DIN 3865 Heavy

Part Number	Dash Size	Hose ID Size		F Thread Size (mm) x TP (mm)	Tube OD (mm)	C Cut-Off Factor (mm)	D Drop (mm)	Hex Dia. CH2 (mm)	Weight (lbs/each)
		(in)	(mm)						
X-0824-FM4H	08	1/2	12.7	M24x1.5	16	59.0	29.0	30	0.44
X-1030-FM4H	10	5/8	15.9	M30x2	20	60.5	31.5	36	0.58
X-1230-FM4H	12	3/4	19.0	M30x2	20	74.0	33.0	36	0.85
X-1236-FM4H	12	3/4	19.0	M36x2	25	78.0	36.0	46	0.88
X-1642-FM4H	16	1	25.4	M42x2	30	96.8	38.0	50	1.43
X-2052-FM4H	20	1 1/4	31.8	M52x2	38	112.7	48.0	60	2.21

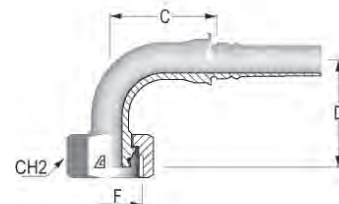

90° Metric Female O-Ring Swivel – DIN 3865 Heavy

Part Number	Dash Size	Hose ID Size		F Thread Size (mm) x TP (mm)	Tube OD (mm)	C Cut-Off Factor (mm)	D Drop (mm)	Hex Dia. CH2 (mm)	Weight (lbs/each)
		(in)	(mm)						
X-0824-FM9H	08	1/2	12.7	M24x1.5	16	55.0	50.0	30	0.43
X-1030-FM9H	10	5/8	15.9	M30x2	20	51.0	55.0	36	0.64
X-1230-FM9H	12	3/4	19.0	M30x2	20	61.0	67.5	36	1.12
X-1236-FM9H	12	3/4	19.0	M36x2	25	61.7	65.0	46	1.17
X-1642-FM9H	16	1	25.4	M42x2	30	86.4	79.0	50	1.53
X-2052-FM9H	20	1 1/4	31.8	M52x2	38	90.9	101.0	60	2.43

Because we continually examine ways to improve our products, we reserve the right to alter specifications or discontinue products without prior notice.

Two-Piece Fittings - Z Series



Interlock Inserts – US End Configurations

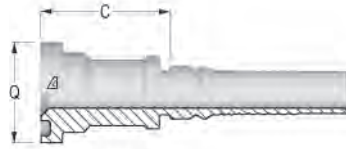

O-Ring Flange SAE J518 Code 62 Interlock

Part Number	Dash Size	Hose ID Size		Q Flange		C Cut-Off Factor	Max WP (psi)	Weight (lbs/each)
		(in)	(mm)	(in)	(mm)			
Z-3224-C62S	32	2	50.8	2.50	63.5	106	6000	3.11
Z-3232-C62S	32	2	50.8	3.13	79.4	104	6000	3.75

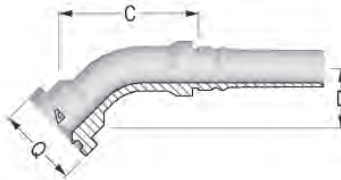

45° O-Ring Flange SAE J518 Code 62 Interlock

Part Number	Dash Size	Hose ID Size		Q Flange		C Cut-Off Factor	D-Drop (mm)	Max WP (psi)	Weight (lbs/each)
		(in)	(mm)	(in)	(mm)				
Z-3232-C624	32	2	50.8	3.13	79.4	141	63	6000	5.14

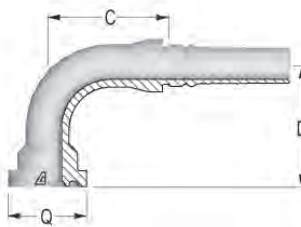

90° O-Ring Flange SAE J518 Code 62 Interlock

Part Number	Dash Size	Hose ID Size		Q Flange		C Cut-Off Factor	D-Drop (mm)	Max WP (psi)	Weight (lbs/each)
		(in)	(mm)	(in)	(mm)				
Z-3224-C629	32	2	50.8	2.50	63.5	134	112	6000	5.41
Z-3232-C629	32	2	50.8	3.13	79.4	132	138	6000	6.17

Because we continually examine ways to improve our products, we reserve the right to alter specifications or discontinue products without prior notice.



HOSES
ONE-PIECE B SERIES
ONE-PIECE D SERIES
ONE-PIECE F & P SERIES
TWO-PIECE FERRULES (A & PFR SERIES)
TWO-PIECE INSERTS (A SERIES)
TWO-PIECE INTERLOCK FERRULES & INSERTS (X & Z SERIES)
QUICK RELEASE
ASSEMBLY EQUIPMENT
TECHNICAL INFORMATION

Interlock Inserts – US End Configurations

NEW

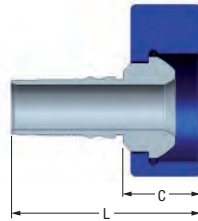

Male Hammer Union Fig. 1502 integral fitting with Lug Nut – Use with Alfabiotech 6000 and 10K Cementing hoses

Part Number	Dash Size	Hose ID (in)	Hose ID (mm)	C Cut-Off (mm)	L Overall Length (mm)	Weight (lbs/each)
Z-3232-MHUN	32	2	50.8	60.8	162.2	14.55

NEW

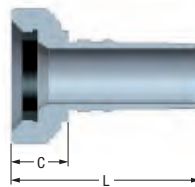

Female Hammer Union Fig. 1502 integral fitting with Rubber Ring – Use with Alfabiotech 6000 and 10K Cementing hoses

Part Number	Dash Size	Hose ID (in)	Hose ID (mm)	C Cut-Off (mm)	L Overall Length (mm)	Weight (lbs/each)
Z-3232-FHUN	32	2	50.8	57.3	158.7	5.73

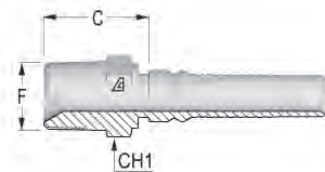

API Male NPT

Part Number	Dash Size	Hose ID Size		F Thread		C Cut-Off Factor (mm)	CH1 (mm)	Weight (lbs/each)
		(in)	(mm)	Dash Size	Size (in) - TPI			
Z-3232-MAPI	32	2	50.8	32	2 - 11 1/2	114.5	65	4.50

Because we continually examine ways to improve our products, we reserve the right to alter specifications or discontinue products without prior notice.

HOSES
ONE-PIECE B SERIES
ONE-PIECE D SERIES
ONE-PIECE F & P SERIES
TWO-PIECE FERRULES (A & PFR SERIES)
TWO-PIECE INSERTS (A-SERIES)
TWO-PIECE INTERLOCK FERRULES & INSERTS (X & Z SERIES)
QUICK RELEASE
ASSEMBLY EQUIPMENT
TECHNICAL INFORMATION

Quick Disconnect



HOSES
ONE-PIECE B SERIES
ONE-PIECE D SERIES
ONE-PIECE F & P SERIES
TWO-PIECE FERRULES (A & PFR SERIES)
TWO-PIECE INSERTS (A SERIES)
TWO-PIECE INTERLOCK FERRULES & INSERTS (X & Z SERIES)
QUICK RELEASE
ASSEMBLY EQUIPMENT
TECHNICAL INFORMATION

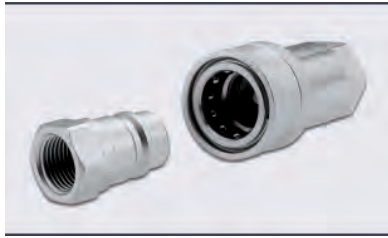

QA-ISO-A 248-249, 270

POPPET STANDARD ISO 7241 A

* Also available in stainless

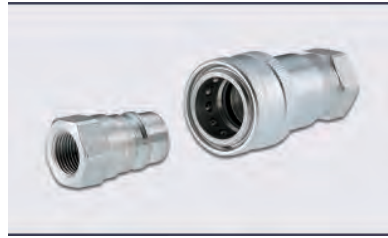

QB-ISO-B 250-251

POPPET STANDARD ISO 7241 B



QP 252-253

AG POPPET INDUSTRY STANDARD

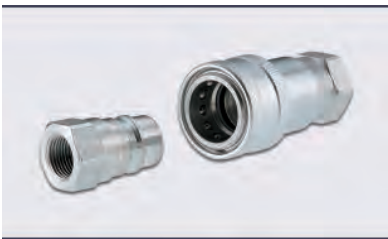

QT 254-255

AG BALL INDUSTRY STANDARD



QC 256-257

PUSH/PULL POPPET STANDARD ISO 7241 A

* Non-stock/Special order



QF 258-259, 271

FLAT FACE STANDARD ISO 16028



QG 260-261

FLAT FACE STANDARD ISO 16028

Connect under pressure

* Non-stock/Special order



QS 262-263, 271

SCREW TYPE FLAT FACE

* Non-stock/Special order



QK 264-265

SCREW TYPE FLAT FACE

Connect under pressure

* Non-stock/Special order



QX 266-267

SCREW TYPE POPPET STANDARD ISO

14540



QM 268-269

MULTI-COUPLING

* Non-stock/Special order

Because we continually examine ways to improve our products, we reserve the right to alter specifications or discontinue products without prior notice.









ARGUS is one of the ALFAGOMMA's Group brands.

Since 1936 ARGUS has been manufacturing high-quality hydraulic components. Ever since the name ARGUS has stood for quality, safety and technical competence.

Many years of experience and constant effort to optimize our products enable us to quickly and flexibly respond to customers' needs.

The products are manufactured in our Italian plants.

 <p>MANUFACTURING PLANTS</p> <p>22</p> <p>IN 10 COUNTRIES</p> <p>ITALY – FINLAND FRANCE – GERMANY SWEDEN – UK USA – BRAZIL CHINA – MALAYSIA</p>	 <p>SUBSIDIARIES AND ASSEMBLY PLANTS</p> <p>86</p> <p>IN 22 COUNTRIES AND 5 CONTINENTS</p>	 <p>QUALITY CERTIFICATION</p> <p>ISO</p> <p>ISO 9001 SINCE 1993 ISO 14001 SINCE 1999</p>	 <p>EMPLOYEES</p> <p>3,800</p> <p>AROUND THE WORLD</p>
<p>ALFAGOMMA // DUNLOPHIFLEX // HIFLEX // ARGUS</p>			

Because we continually examine ways to improve our products, we reserve the right to alter specifications or discontinue products without prior notice.

Quick Disconnect



- HOSES
- ONE-PIECE B SERIES
- ONE-PIECE D SERIES
- ONE-PIECE F & P SERIES
- TWO-PIECE FERRULES (A & PFR SERIES)
- TWO-PIECE INSERTS (A SERIES)
- TWO-PIECE INTERLOCK FERRULES & INSERTS (X & Z SERIES)
- QUICK RELEASE
- ASSEMBLY EQUIPMENT
- TECHNICAL INFORMATION



We develop every kind of quick release and multi-coupling system according to customer's needs or specifications

Because we continually examine ways to improve our products, we reserve the right to alter specifications or discontinue products without prior notice.

QUICK RELEASE COUPLING

For fast and easy connections of hydraulic hoses, the ALFAGOMMA range of fluid components includes the ARGUS series of quick disconnect couplings, with products complying to international standards ISO 7241-1 A & B, ISO 5675 and ISO 16028, having poppet and flat face valve respectively.

The standardized design assures the complete interchangeability with corresponding couplings currently in use.

Made from high strength carbon steel as the basic material, hardened in parts subject to wear, ARGUS couplings feature a chrome-III zinc plating with a long lasting resistance to oxidation (TOP COAT, patented).

The mechanical and fluid dynamic performance are maximized by means of specific geometries defined through CFD calculations. Additional extensive testing is carried out after production following the requirements of ISO 7241-2 standard.

ISO-A range includes the true general purpose quick release couplings, with sizes from 1/4" to 1 1/2", BSPP, NPTF and metric threaded connections, and working pressure up to 350 bar. Agricultural machinery is the main application for ISO-A for ISO-A couplings.

ISO 7241-1 B series is more employed in the industrial sector (pressures can reach 400 bar), for equipment powered and controlled by hydraulic systems.

The flat faced range is the optimal choice to avoid circuit contamination and oil leakage when connecting and disconnecting.

Flat faced couplings are widely used on construction equipment, but also in hostile environments where spillage can constitute a danger. They have sizes from 1/4" to 1", constant working pressure of 350 bar and minimized flow losses.

Screw quick couplings are also included in the ARGUS family. Connection under residual pressure is made possible by specific couplings with poppet or flat face valve. Further sizes and types, including customized multi-coupling systems, are available on request.

Not all items are available from stock. Please consult factory.

POPPET VALVE	FLAT FACE VALVE	SCREW TYPE		MULTI-COUPLING
		POPPET	FLAT FACE	
QA-ISO-A	QF 350 bar *	QH	QR	QM
QA-ISO-A SS	QG MP *	QX	QS *	
QB-ISO-B			QK *	
QP				
QT				
QC				
QO				
QJ				
QE				
QN				

* Patent Pending

Because we continually examine ways to improve our products, we reserve the right to alter specifications or discontinue products without prior notice.

- HOSES
- ONE-PIECE B SERIES
- ONE-PIECE D SERIES
- ONE-PIECE F & P SERIES
- TWO-PIECE FERRULES (A & PFR SERIES)
- TWO-PIECE INSERTS (A SERIES)
- TWO-PIECE INTERLOCK FERRULES & INSERTS (X & Z SERIES)
- QUICK RELEASE
- ASSEMBLY EQUIPMENT
- TECHNICAL INFORMATION

TOP COAT TREATMENT

Thanks to the exclusive ALFAGOMMA TOP COAT – Galvanic Coating – proprietary technology, the complete range of ARGUS Quick release couplings can boast an extraordinary wear and corrosion resistance, so as to guarantee a longer lifespan to your system.

ALFAGOMMA TOP COAT is based on a system of trivalent passivation which reaches outstanding rusting and corrosion resistance levels. Tested in accordance with ASTM B117-03 and UNI ISO 9227 standards, ALFAGOMMA TOP COAT ensures over 1000 hours to red rust.

All ALFAGOMMA metal parts feature TOP COAT an innovative proprietary surface treatment developed and patented by the ALFAGOMMA Research & Development team

- Corrosion resistance exceeding 500 hrs white and 1000 hrs red rust resistance – ASTM B117-03 and UNI ISO 9227 standards
- Exceptional interfacial adhesion and outstanding impact resistance, with almost no micro-cracking, chipping and delamination
- Trivalent passivation and high resistance sealing
- Chromium(VI)-free in conformity with the European directive 2000/53/EC

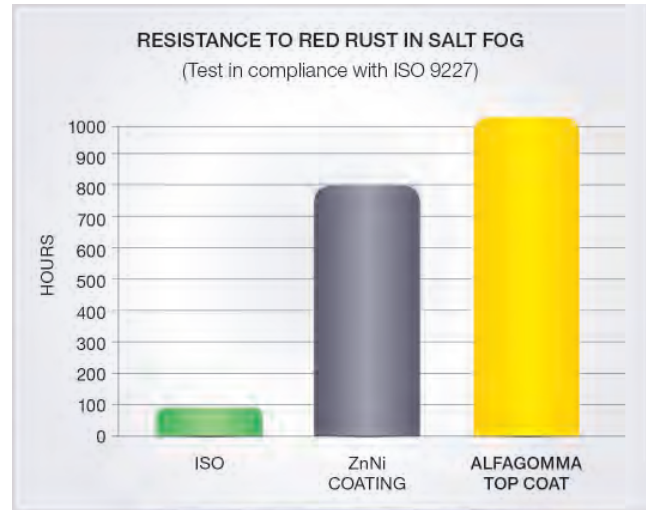

Because we continually examine ways to improve our products, we reserve the right to alter specifications or discontinue products without prior notice.

COUPLING IDENTIFICATION PROFILE

Quick Connect Couplings Part Number Configurator

Quick Coupling	Coupling Type	Coupling Gender	Coupling Size	Thread Size	Thread Configuration	Optional for Stainless Steel
Q						SS
All Quick Couplings start with Q	A= ISO A B= ISO B C= ISO A Push/Pull F= Flat Face G= Flat Face Male CUP* K= Flat Face Screw Type CUP* T= AG Ball P= AG Poppet X= 10K S= Flat Face Screw Type *Connect Under Pressure	F= Female M= Male C= Dust Cap P= Dust Plug	-04 or 1/4" -05 or 5/16" -06 or 3/8" -08 or 1/2" -10 or 5/8" -12 or 3/4" -14 or 7/8" -16 or 1" -20 or 1 1/4" -24 or 1 1/2" -32 or 2" *For Metric, Enter Exact Thread Size in mm.	Suffix Description FNPR Female National Pipe Rigid MNPT Male Pipe NPTF MJIC Male JIC FORB Female O-Ring Boss MORB Male O-Ring Boss MSAE Male SAE MOFS Male O-Ring Face Seal FBPP Female British Pipe Parallel FBPT Female British Pipe Tapered MBPP Male British Pipe Parallel MBPT Male British Pipe Tapered/JIS MMSH Male Metric Solid-Heavy MMSL Male Metric Solid-Light		

Notes:

ISO A in accordance to ISO 7241-1 A
 ISO B in accordance to ISO 7241-1 B
 Flat Face (F) in accordance to ISO 16028
 Flat Face Screw Type (K) in accordance to ISO 14540
 10K (X) in accordance to ISO 14540 for use on power tools to 10,000 PSI

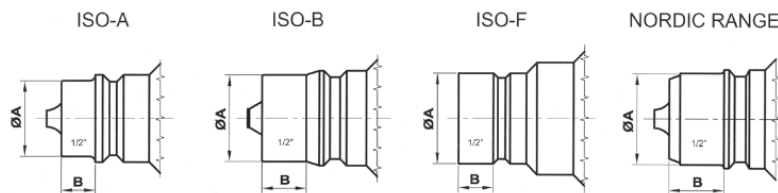

Size (in)	Dimensions (mm)							
	ISO-A		ISO-B		ISO-F		Nordic Range	
	A	B	A	B	A	B	A	B
3/16	-	-	10.85	7.9	-	-	9.3	6.8
1/4	11.8	5.6	14.15	9.65	16.15	5.75	11.9	11.8
3/8	17.25	8.9	19.05	12.45	19.7	4.75	19.9	13.7
1/2	20.5	9.3	23.5	12.2	24.5	9.85	24.6	15
5/8	-	-	-	-	27	9.85	-	-
3/4	29.05	16	31.4	18.8	29.9	11.4	32.7	18.5
1	34.3	19.85	37.75	20.6	36	10.9	41	21.5
1-1/4	44.95	25	-	-	-	-	-	-
1-1/2	54.95	30.7	44.45	32.6	-	-	-	-
2	65.05	35.1	63.2	38.1	-	-	-	-

Because we continually examine ways to improve our products, we reserve the right to alter specifications or discontinue products without prior notice.



HOSES
 ONE-PIECE B SERIES
 ONE-PIECE D SERIES
 ONE-PIECE F & P SERIES
 TWO-PIECE FERRULES (A & PFR SERIES)
 TWO-PIECE INSERTS (A-SERIES)
 TWO-PIECE INTERLOCK FERRULES & INSERTS (X & Z-SERIES)
 QUICK RELEASE
 ASSEMBLY EQUIPMENT
 TECHNICAL INFORMATION

Quick Disconnect



HOSES
ONE-PIECE B SERIES
ONE-PIECE D SERIES
ONE-PIECE F & P SERIES
TWO-PIECE FERRULES (A & PFR SERIES)
TWO-PIECE INSERTS (A SERIES)
TWO-PIECE INTERLOCK FERRULES & INSERTS (X & Z SERIES)
QUICK RELEASE
ASSEMBLY EQUIPMENT
TECHNICAL INFORMATION

QA-ISO-A

POPPET STANDARD ISO 7241 A

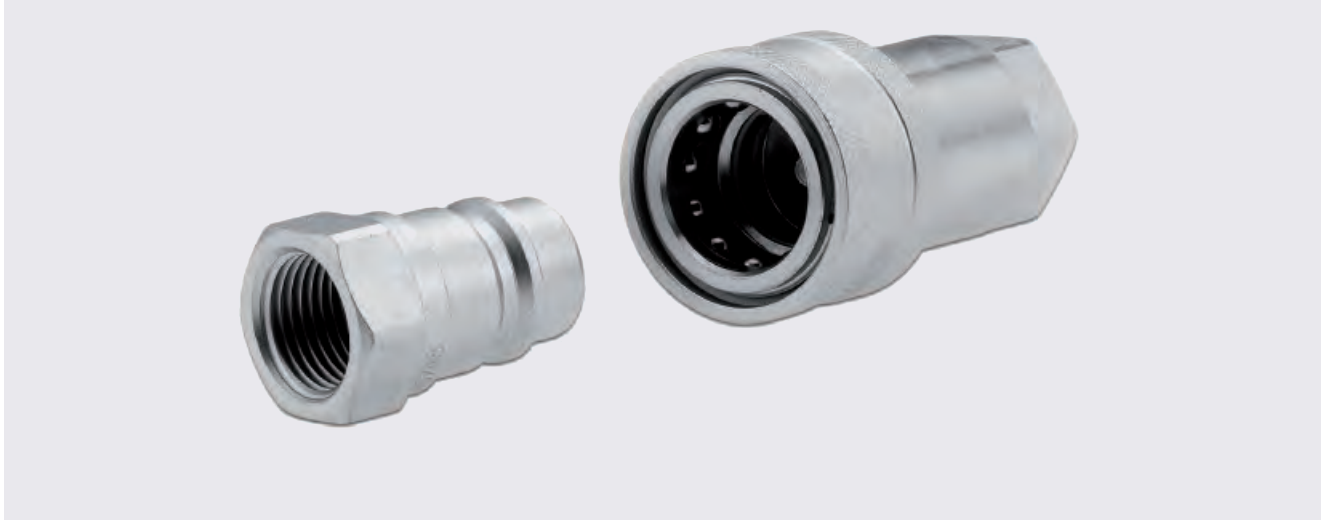

DN 6 to 51
1/4" to 2"

to max WP 350 bar
5075 PSI

- Quick and simple coupling and uncoupling
- Cost effective
- Also available in stainless steel

General features: ARGUS ISO 7241-1 series "A" quick release couplings are used for quick coupling and uncoupling of hydraulic lines. During the coupling action in zero or low-pressure ranges, valves that release or block the flow are automatically activated. The QA-ISO-A quick release coupling, formed by the coupling plug and the coupling socket, is connected by pushing on a sleeve. This guarantees a flush connection between the two coupling halves.

Materials: galvanized steel with hardened parts subject to wear - NBR O-rings (other materials optional) - Thermoplastic dust cap and dust plug. Cr-III zinc plating through additional passivation for improved surface protection (TOP COAT for metric version).

Application: suitable for liquid lines with mineral oil-based hydraulic fluids to DIN 51524 T1+T2.

Norm:
ISO 7241 A

Temperature range:
-4°F (-20°C) to +212°F (+100°C)
Temp. range for metric version -22°F (-30°C) to 257°F (+125°C)

Note: rated flow / pressure drop compliant with ISO 7241-1 standard.

Specific instructions for installation, use and maintenance are separately provided.

Because we continually examine ways to improve our products, we reserve the right to alter specifications or discontinue products without prior notice.



STANDARD ISO 7241 A - POPPET QA-ISO-A

Female coupling - Female thread



Item Code				Working Pressure (psi)	Burst Pressure (psi)	Thread 1	F1	D1	CH	L1	L
	Dash	(mm)	(in)					(mm)	(mm)	(mm)	(mm)
QAF-0404-FNPR	04	6.0	1/4	5075	20300	NPTF	1/4-18	26.0	19.0	50.0	74.20
QAF-0606-FNPR	06	10.0	3/8	4568	18270	NPTF	3/8-18	31.5	22.0	57.1	78.50
QAF-0808-FNPR	08	13.0	1/2	3915	15660	NPTF	1/2-14	38.5	27.0	66.0	88.20
QAF-1212-FNPR	12	19.0	3/4	3625	14500	NPTF	3/4-14	48.0	34.0	82.5	110.40
QAF-1616-FNPR	16	25.0	1	2900	11600	NPTF	1-11 1/2	56.0	41.0	100.0	132.90
QAF-2424-FNPR	24	38.0	1 1/2	2320	9280	NPTF	1 1/2-11 1/2	84.5	60.0	133.0	167.00
QAF-3232-FNPR	32	51.0	2	1450	5800	NPTF	2-11 1/2	99.0	75.0	165.0	210.00

Other threads available. Please consult factory.

STANDARD ISO 7241 A - POPPET QA-ISO-A

Male coupling - Female thread

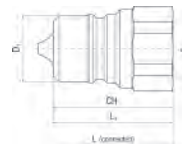

Item Code				Working Pressure (psi)	Burst Pressure (psi)	Thread 1	F1	D1	CH	L1	L
	Dash	(mm)	(in)					(mm)	(mm)	(mm)	(mm)
QAM-0404-FNPR	04	6.0	1/4	5075	20300	NPTF	1/4-18	11.8	19.0	38.5	74.20
QAM-0606-FNPR	06	10.0	3/8	4568	18270	NPTF	3/8-18	17.3	22.0	39.0	78.50
QAM-0808-FNPR	08	13.0	1/2	3915	15660	NPTF	1/2-14	20.5	27.0	44.0	88.20
QAM-1212-FNPR	12	19.0	3/4	3625	14500	NPTF	3/4-14	29.0	34.0	55.0	110.40
QAM-1616-FNPR	16	25.0	1	2900	11600	NPTF	1-11 1/2	34.3	41.0	66.0	132.90
QAM-2424-FNPR	24	38.0	1 1/2	2320	9280	NPTF	1 1/2-11 1/2	55.0	60.0	83.5	167.00
QAM-3232-FNPR	32	51.0	2	1450	5800	NPTF	2-11 1/2	65.0	75.0	105.0	210.00

Other threads available. Please consult factory.

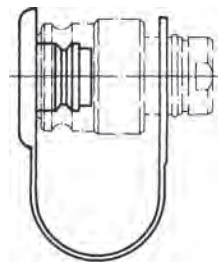

STANDARD ISO 7241 A - POPPET QA-ISO-A

Dust plug for female coupling

Item Code	Color	Material			
			Dash	(mm)	(in)
QAP-04	RED	PE	04	6.0	1/4
QAP-06	RED	PE	06	10.0	3/8
QAP-08	RED	PE	08	13.0	1/2
QAP-12	RED	PE	12	19.0	3/4
QAP-16	RED	PE	16	25.0	1

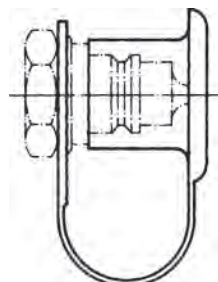

STANDARD ISO 7241 A - POPPET QA-ISO-A

Dust cap for male coupling

Item Code	Color	Material			
			Dash	(mm)	(in)
QAC-04	RED	PE	04	6.0	1/4
QAC-06	RED	PE	06	10.0	3/8
QAC-08	RED	PE	08	13.0	1/2
QAC-12	RED	PE	12	19.0	3/4
QAC-16	RED	PE	16	25.0	1

Because we continually examine ways to improve our products, we reserve the right to alter specifications or discontinue products without prior notice.

Quick Disconnect



HOSES

QB-ISO-B

POPPET STANDARD ISO 7241 B

ONE-PIECE
B SERIES

ONE-PIECE
D SERIES

ONE-PIECE
F & P SERIES



DN 6 TO 25
1/4" to 1"



to max WP 300 bar
4350 PSI

- Quick and simple coupling and uncoupling

TWO-PIECE FERRULES
(A & PFR SERIES)

TWO-PIECE INSERTS
(A SERIES)

TWO-PIECE INTERLOCK
FERRULES & INSERTS
(X & Z SERIES)

QUICK
RELEASE

ASSEMBLY
EQUIPMENT

TECHNICAL
INFORMATION

General features: ARGUS ISO 7241-1 series "B" quick release couplings are used for quick coupling and uncoupling of hydraulic lines. During the coupling action in zero or low-pressure ranges, valves that release or block the flow are automatically activated. The QB-ISO-B quick release coupling, formed by the coupling plug and the coupling socket, is connected by pushing on a sleeve. This guarantees a flush connection between the two coupling halves.

Materials: galvanized steel with hardened parts subject to wear - NBR O-rings (other materials optional) - Thermoplastic dust cap and dust plug. Cr-III zinc plating through additional passivation for improved surface protection. Also available in stainless steel.

Application: suitable for liquid lines with mineral oil-based hydraulic fluids to DIN 51524 T1+T2.

Norm: ISO 7241 B

Temperature range:
-4°F (-20°C) to +212°F (+100°C)

Note: rated flow / pressure drop compliant with ISO 7241-1 standard.

Specific instructions for installation, use and maintenance are separately provided.

Because we continually examine ways to improve our products, we reserve the right to alter specifications or discontinue products without prior notice.



STANDARD ISO 7241 B - POPPET QB-ISO-B

Female coupling - Female thread

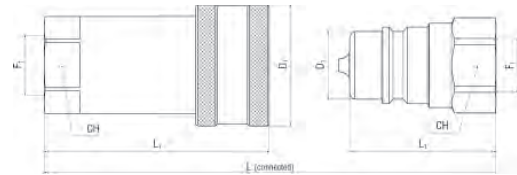

Item Code				Working Pressure (psi)	Burst Pressure (psi)	Thread 1	F1	D1 (mm)	CH (mm)	L1 (mm)	L (mm)
	Dash	(mm)	(in)								
QBF-0404-FNPR	04	6.0	1/4	4350	17400	NPTF	1/4-18	28.5	19.0	58.0	72.00
QBF-0606-FNPR	06	10.0	3/8	4060	16240	NPTF	3/8-18	35.0	24.0	65.0	81.00
QBF-0808-FNPR	08	13.0	1/2	3625	14500	NPTF	1/2-14	44.5	28.5	74.0	93.50
QBF-1212-FNPR	12	19.0	3/4	2900	11600	NPTF	3/4-14	54.0	36.0	92.0	113.00
QBF-1616-FNPR	16	25.0	1	2175	8700	NPTF	1-11 1/2	63.5	41.0	103.0	127.00

Other threads available. Please consult factory.

STANDARD ISO 7241 B - POPPET QB-ISO-B

Male coupling - Female thread

Item Code				Working Pressure (psi)	Burst Pressure (psi)	Thread 1	F1	D1 (mm)	CH (mm)	L1 (mm)	L (mm)
	Dash	(mm)	(in)								
QBM-0404-FNPR	04	6.0	1/4	4350	17400	NPTF	1/4-18	14.2	19.0	36.0	72.00
QBM-0606-FNPR	06	10.0	3/8	4060	16240	NPTF	3/8-18	19.1	24.0	40.0	81.00
QBM-0808-FNPR	08	13.0	1/2	3625	14500	NPTF	1/2-14	23.5	28.5	46.5	93.50
QBM-1212-FNPR	12	19.0	3/4	2900	11600	NPTF	3/4-14	31.4	36.0	56.0	113.00
QBM-1616-FNPR	16	25.0	1	2175	8700	NPTF	1-11 1/2	37.8	41.0	63.0	127.00

Other threads available. Please consult factory.

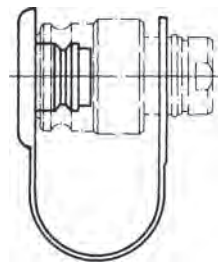

STANDARD ISO 7241 B - POPPET QB-ISO-B

Dust plug for female coupling

Item Code	Color	Material			
			Dash	(mm)	(in)
QBP-04	RED	PE	04	6.0	1/4
QBP-06	RED	PE	06	10.0	3/8
QBP-08	RED	PE	08	13.0	1/2
QBP-12	RED	PE	12	19.0	3/4
QBP-16	RED	PE	16	25.0	1

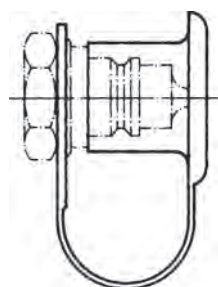

STANDARD ISO 7241 B - POPPET QB-ISO-B

Dust cap for male coupling

Item Code	Color	Material			
			Dash	(mm)	(in)
QBC-04	RED	PE	04	6.0	1/4
QBC-06	RED	PE	06	10.0	3/8
QBC-08	RED	PE	08	13.0	1/2
QBC-12	RED	PE	12	19.0	3/4
QBC-16	RED	PE	16	25.0	1

Because we continually examine ways to improve our products, we reserve the right to alter specifications or discontinue products without prior notice.

Quick Disconnect



HOSES
ONE-PIECE B SERIES
ONE-PIECE D SERIES
ONE-PIECE F & P SERIES
TWO-PIECE FERRULES (A & PFR SERIES)
TWO-PIECE INSERTS (A SERIES)
TWO-PIECE INTERLOCK FERRULES & INSERTS (X & Z SERIES)
QUICK RELEASE
ASSEMBLY EQUIPMENT
TECHNICAL INFORMATION

QP

POPPET INDUSTRY STANDARD ISO 5675



DN 6 to 25
1/4" to 1"
.....

to max WP 350 bar
5075 PSI

- Agricultural/normal series
- Compatibility with other couplings in-use
- 1/2" size compatible with ISO 7241-1-A

General features: ARGUS Agricultural/Normal quick release couplings are used for quick coupling and uncoupling of hydraulic lines. During the coupling action in zero or low-pressure ranges, valves that release or block the flow are automatically activated. The QP quick release coupling, formed by the coupling plug and the coupling socket, is connected by pushing on a sleeve. This guarantees a flush connection between the two coupling halves.

Materials: galvanized steel with hardened parts subject to wear - NBR O-rings (other materials optional) - Thermoplastic dust cap and dust plug. Cr-III zinc plating through additional passivation for improved surface protection.

Application: suitable for liquid lines with mineral oil-based hydraulic fluids to DIN 51524 T1+T2.

Temperature range:
-4°F (-20°C) to +212°F (+100°C)

Note: specific instructions for installation, use and maintenance are separately provided.

Because we continually examine ways to improve our products, we reserve the right to alter specifications or discontinue products without prior notice.



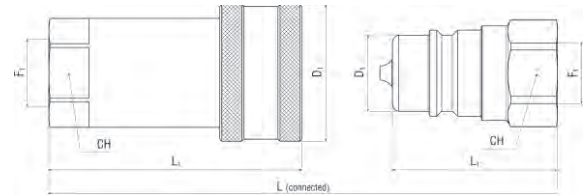

INDUSTRY STANDARD - POPPET QP

Female coupling - Female thread

Item Code				Working Pressure (psi)	Burst Pressure (psi)	Thread 1	F1	D1	CH	L1	L
	Dash	(mm)	(in)					(mm)	(mm)	(mm)	(mm)
QPF-0404-FNPR	04	6.0	1/4	5075	20300	NPTF	1/4-18	27.6	19.0	53.5	72.00
QPF-0606-FNPR	06	10.0	3/8	3915	15660	NPTF	3/8-18	34.0	24.0	63.0	83.00
QPF-1212-FNPR	12	19.0	3/4	2900	11600	NPTF	3/4-14	48.2	34.0	82.5	108.00
QPF-1616-FNPR	16	25.0	1	2900	11600	NPTF	1-11 1/2	56.5	41.0	96.5	127.00

Other threads available. Please consult factory. 1/2" size interchanges with ISO 7241 A. See page 249 for female part number.

INDUSTRY STANDARD - POPPET QP

Male coupling - Female thread

Item Code				Working Pressure (psi)	Burst Pressure (psi)	Thread 1	F1	D1	CH	L1	L
	Dash	(mm)	(in)					(mm)	(mm)	(mm)	(mm)
QPM-0404-FNPR	04	6.0	1/4	5075	20300	NPTF	1/4-18	14.1	19.0	36.0	72.00
QPM-0606-FNPR	06	10.0	3/8	3915	15660	NPTF	3/8-18	18.9	24.0	40.0	83.00
QPM-1212-FNPR	12	19.0	3/4	2900	11600	NPTF	3/4-14	27.9	34.0	49.0	108.00
QPM-1616-FNPR	16	25.0	1	2900	11600	NPTF	1-11 1/2	31.3	41.0	64.0	127.00

Other threads available. Please consult factory. 1/2" size interchanges with ISO 7241 A. See page 249 for female part number.

HOSES

ONE-PIECE
B SERIES

ONE-PIECE
D SERIES

ONE-PIECE
F & P SERIES

TWO-PIECE FERRULES
(A & PFR SERIES)

TWO-PIECE INSERTS
(A SERIES)

TWO-PIECE INTERLOCK
FERRULES & INSERTS
(X & Z SERIES)

QUICK
RELEASE

ASSEMBLY
EQUIPMENT

TECHNICAL
INFORMATION

Because we continually examine ways to improve our products, we reserve the right to alter specifications or discontinue products without prior notice.

Quick Disconnect



HOSES
ONE-PIECE B SERIES
ONE-PIECE D SERIES
ONE-PIECE F & P SERIES
TWO-PIECE FERRULES (A & PFR SERIES)
TWO-PIECE INSERTS (A SERIES)
TWO-PIECE INTERLOCK FERRULES & INSERTS (X & Z SERIES)
QUICK RELEASE
ASSEMBLY EQUIPMENT
TECHNICAL INFORMATION

QT

BALL INDUSTRY STANDARD ISO 5675



- Ball valve
- Agricultural/normal series
- Compatibility with other couplings in-use
- 1/2" size compatible with ISO 7241-1-A

General features: ARGUS Agricultural/Normal quick release couplings with ball valve are used for quick coupling and uncoupling of hydraulic lines. During the coupling action in zero or low-pressure ranges, valves that release or block the flow are automatically activated. The QT quick release coupling, formed by the coupling plug and the coupling socket, is connected by pushing on a sleeve.

Materials: galvanized steel with hardened parts subject to wear - NBR O-rings (other materials optional) - Thermoplastic dust cap and dust plug. Cr-III zinc plating through additional passivation for improved surface protection.

Application: suitable for liquid lines with mineral oil-based hydraulic fluids to DIN 51524 T1+T2.

Temperature range:
-4°F (-20°C) to +212°F (+100°C)

Note: specific instructions for installation, use and maintenance are separately provided.

Because we continually examine ways to improve our products, we reserve the right to alter specifications or discontinue products without prior notice.



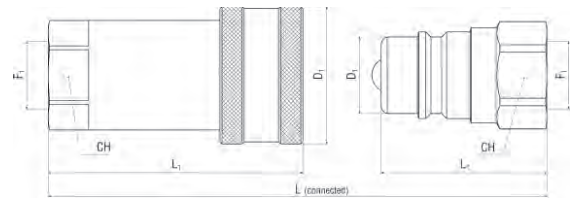

INDUSTRY STANDARD - Ball QT

Female coupling - Female thread

Item Code				Working Pressure (psi)	Burst Pressure (psi)	Thread 1	F1	D1 (mm)	CH (mm)	L1 (mm)	L (mm)
	Dash	(mm)	(in)								
QTF-0404-FNPR	04	6.0	1/4	5075	20300	NPTF	1/4-18	27.6	19.0	53.5	72.00
QTF-0606-FNPR	06	10.0	3/8	3915	15660	NPTF	3/8-18	34.0	24.0	63.0	83.00
QTF-0808-FNPR	08	13.0	1/2	3915	15660	NPTF	1/2-14	38.5	27.0	66.0	88.20
QTF-1212-FNPR	12	19.0	3/4	2900	11600	NPTF	3/4-14	48.2	34.0	82.5	108.00
QTF-1616-FNPR	16	25.0	1	2900	11600	NPTF	1-11 1/2	56.5	41.0	96.5	127.00

Other threads available. Please consult factory.

INDUSTRY STANDARD - Ball QT

Male coupling - Female thread

Item Code				Working Pressure (psi)	Burst Pressure (psi)	Thread 1	F1	D1 (mm)	CH (mm)	L1 (mm)	L (mm)
	Dash	(mm)	(in)								
QTM-0404-FNPR	04	6.0	1/4	5075	20300	NPTF	1/4-18	14.1	19.0	36.0	72.00
QTM-0606-FNPR	06	10.0	3/8	3915	15660	NPTF	3/8-18	18.9	24.0	40.0	83.00
QTM-0808-FNPR	08	13.0	1/2	3915	15660	NPTF	1/2-14	20.5	27.0	44.0	88.20
QTM-1212-FNPR	12	19.0	3/4	2900	11600	NPTF	3/4-14	27.9	34.0	49.0	108.00
QTM-1616-FNPR	16	25.0	1	2900	11600	NPTF	1-11 1/2	31.3	41.0	64.0	127.00

Other threads available. Please consult factory.

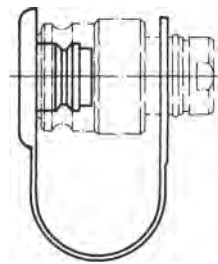

INDUSTRY STANDARD - POPPET QT

Dust plug for female coupling

Item Code	Color	Material			
			Dash	(mm)	(in)
QTP-04	RED	PE	04	6.0	1/4
QTP-06	RED	PE	06	10.0	3/8
QTP-12	RED	PE	12	19.0	3/4
QTP-16	RED	PE	16	25.0	1

1/2" size interchanges with ISO 7241 A. See page 249 for female part number.

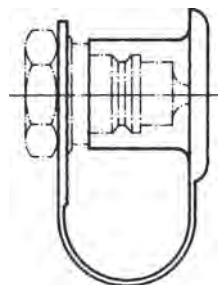

INDUSTRY STANDARD - POPPET QT

Dust cap for male coupling

Item Code	Color	Material			
			Dash	(mm)	(in)
QTC-04	RED	PE	04	6.0	1/4
QTC-06	RED	PE	06	10.0	3/8
QTC-12	RED	PE	12	19.0	3/4
QTC-16	RED	PE	16	25.0	1

1/2" size interchanges with ISO 7241 A. See page 249 for female part number.

Because we continually examine ways to improve our products, we reserve the right to alter specifications or discontinue products without prior notice.

Quick Disconnect



HOSES

QC-ISO-A

POPPET STANDARD ISO 7241 A

ONE-PIECE
B SERIES

TOP COAT

ONE-PIECE
D SERIES

ONE-PIECE
F & P SERIES



TWO-PIECE FERRULES
(A & PFR SERIES)

TWO-PIECE INSERTS
(A SERIES)

TWO-PIECE INTERLOCK
FERRULES & INSERTS
(X & Z SERIES)

QUICK
RELEASE

ASSEMBLY
EQUIPMENT

TECHNICAL
INFORMATION



DN 6 to 25
1/4" to 1"



to max WP 400 bar
5800 PSI

- Quick and simple coupling and uncoupling
- One-hand push pull operation
- Break-away function
- Low pressure drop

General features: ARGUS QC-ISO-A quick release couplings are used for quick coupling and uncoupling of loaded lines. During the coupling action in zero or low-pressure ranges, valves that release or block the flow are automatically activated. The QC-ISO-A quick release coupling, formed by the coupling plug and the coupling socket, is coupled by pushing on a sleeve. This guarantees a flush connection between the two coupling halves. The sleeve is designed so that it has only to be moved in the relevant direction for disconnecting or connecting of coupling halves. QC-ISO-A quick release couplings can be used as pull-off couplings by panel mounting the sleeve bush.

Materials: galvanized steel with hardened parts subject to wear - HNBR O-rings (other materials optional) - Galvanized steel threaded adapters for various connection types - Thermoplastic dust cap and dust plug (see QA-ISO-A). Top Coat Cr-III zinc plating with additional trivalent passivation for outstanding surface protection.

Application: suitable for liquid lines with mineral oil-based hydraulic fluids to DIN 51524 T1+T2. Also available for flame-resistant hydraulic fluids to VDMA 24317, for pneumatic and water hydraulics in appropriate materials on request.

Norm:
ISO 7241 A
SAE J 1036

Temperature range:
-22°F (-30°C) to +257°F (+125°C)

Note: other sizes and connection types available on request.

Specific instructions for installation, use and maintenance are separately provided.

Because we continually examine ways to improve our products, we reserve the right to alter specifications or discontinue products without prior notice.



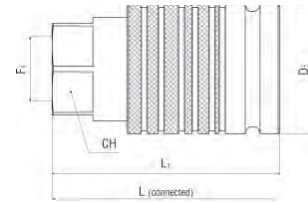

STANDARD ISO 7241 A PUSH PULL - POPPET QO-ISO-A

Female coupling - Female thread

Item Code				Working Pressure (psi)	Burst Pressure (psi)	Thread 1	F1	D1	CH	L1	L
	Dash	(mm)	(in)					(mm)	(mm)	(mm)	(mm)
QCF-0404-FNPR	04	6.0	1/4	5800	23200	NPTF	1/4-18	25.0	19.0	46.5	64.10
QCF-0606-FNPR	06	10.0	3/8	5800	23200	NPTF	3/8-18	32.0	22.0	55.5	75.20
QCF-0808-FNPR	08	13.0	1/2	3625	14500	NPTF	1/2-14	38.0	27.0	63.5	86.70
QCF-1212-FNPR	12	19.0	3/4	3625	14500	NPTF	3/4-14	45.0	35.0	80.0	105.90
QCF-1616-FNPR	16	25.0	1	3625	14500	NPTF	1-11 1/2	52.0	40.0	94.5	121.40
QCF-0404-FORB	04	6.0	1/4	5800	23200	SAE-OB	7/16-20	25.0	19.0	46.5	64.10
QCF-0606-FORB	06	10.0	3/8	5800	23200	SAE-OB	9/16-18	32.0	24.0	57.5	79.20
QCF-0808-FORB	08	13.0	1/2	3625	14500	SAE-OB	3/4-16	38.0	27.0	63.5	86.70
QCF-1212-FORB	12	19.0	3/4	3625	14500	SAE-OB	1 1/16-12	45.0	35.0	82.5	110.90
QCF-1616-FORB	16	25.0	1	3625	14500	SAE-OB	1 5/16-12	52.0	40.0	94.5	121.40

NPTF connection according to ANSI B1-20.3, SAE UNF/UN connection according to SAE J 1926-1.

Other threads available. Please consult factory.

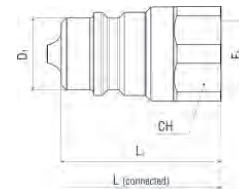

STANDARD ISO 7241 A PUSH PULL - POPPET QO-ISO-A

Male coupling - Female thread

Item Code				Working Pressure (psi)	Burst Pressure (psi)	Thread 1	F1	D1	CH	L1	L
	Dash	(mm)	(in)					(mm)	(mm)	(mm)	(mm)
QCM-0404-FORB	04	6.0	1/4	5800	23200	SAE-OB	7/16-20	11.8	19.0	32.0	64.10
QCM-0606-FORB	06	10.0	3/8	5800	23200	SAE-OB	9/16-18	17.3	24.0	39.5	79.20
QCM-0808-FORB	08	13.0	1/2	3625	14500	SAE-OB	3/4-16	20.5	27.0	49.5	86.70
QCM-1212-FORB	12	19.0	3/4	3625	14500	SAE-OB	1 1/16-12	29.1	35.0	55.5	110.90
QCM-1616-FORB	16	25.0	1	3625	14500	SAE-OB	1 5/16-12	34.3	40.0	60.5	121.30

For male coupling with female NPT threads, please refer to page 249 for part numbers.

NPTF connection according to ANSI B1-20.3, SAE UNF/UN connection according to SAE J 1926-1.

Other threads available. Please consult factory.

HOSES

ONE-PIECE
B SERIES

ONE-PIECE
D SERIES

ONE-PIECE
F & P SERIES

TWO-PIECE FERRULES
(A & PFR SERIES)

TWO-PIECE INSERTS
(A-SERIES)

TWO-PIECE INTERLOCK
FERRULES & INSERTS
(X & Z-SERIES)

QUICK
RELEASE

ASSEMBLY
EQUIPMENT

TECHNICAL
INFORMATION

Because we continually examine ways to improve our products, we reserve the right to alter specifications or discontinue products without prior notice.

Quick Disconnect



HOSES
ONE-PIECE B SERIES
ONE-PIECE D SERIES
ONE-PIECE F & P SERIES
TWO-PIECE FERRULES (A & PFR SERIES)
TWO-PIECE INSERTS (A SERIES)
TWO-PIECE INTERLOCK FERRULES & INSERTS (X & Z SERIES)
QUICK RELEASE
ASSEMBLY EQUIPMENT
TECHNICAL INFORMATION

QF

FLAT FACE STANDARD ISO 16028

TOP COAT



PATENT PENDING



DN 6 to 25
1/4" to 1"



WP 350 bar
5075 PSI

- Flow performance optimized by CFD
- Low leak-oil rates, eco-friendly
- Robust, compact and lightweight
- Extended temperature range

General features: ARGUS QF flat face quick release couplings are used for quick coupling and uncoupling of hydraulic lines. During the coupling action in zero or low-pressure ranges, valves that release or block the flow are automatically activated. The QF flat face quick release coupling, formed by a coupling plug and a coupling socket, is coupled by pushing on a sleeve. This guarantees a flush connection between the two coupling halves. The sleeve is designed to be moved in the relevant direction for disconnecting or connecting the coupling halves. A safety system against accidental uncoupling is present on the female part.

Materials: galvanized steel with hardened parts subject to wear. HNBR seals (other materials on request) - Backup rings PTFE - Thermoplastic dust cap and dust plug. Top Coat Cr-III zinc plating with additional trivalent passivation for outstanding surface protection.

Application: suitable for liquid lines with mineral oil-based hydraulic fluids to DIN 51524 T1+T2. Also available for flame-resistant hydraulic fluids to VDMA 24317, for pneumatic and water hydraulics in appropriate materials on request.

Norm: ISO 16028

Temperature range:
-22°F (-30°C) to +257°F (+125°C)

Note: other sizes and connection types available on request.

Specific instructions for installation, use and maintenance are separately provided.

Because we continually examine ways to improve our products, we reserve the right to alter specifications or discontinue products without prior notice.



STANDARD ISO 16028 - FLAT FACE QF

Female coupling - Female thread

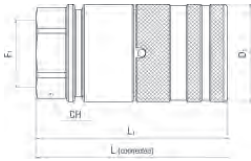

Item Code	⊗			Working Pressure (psi)	Burst Pressure (psi)	Thread 1	F1	D1	CH	L1	L
	Dash	(mm)	(in)					(mm)	(mm)	(mm)	(mm)
QFF-0404-FNPR	04	6.0	1/4	5075	20300	NPTF	1/4-18	26.0	22.0	57.8	97.00
QFF-0606-FNPR	06	10.0	3/8	5075	20300	NPTF	3/8-18	32.0	27.0	69.3	117.00
QFF-0608-FNPR	06	10.0	3/8	5075	20300	NPTF	1/2-14	32.0	27.0	69.3	117.00
QFF-0808-FNPR	08	13.0	1/2	5075	20300	NPTF	1/2-14	38.0	32.0	74.5	125.00
QFF-0812-FNPR	08	13.0	1/2	5075	20300	NPTF	3/4-14	38.0	32.0	74.5	125.00
QFF-1012-FNPR	10	16.0	5/8	5075	20300	NPTF	3/4-14	40.0	34.0	81.3	134.00
QFF-1212-FNPR	12	19.0	3/4	5075	20300	NPTF	3/4-14	48.0	42.0	93.0	156.00
QFF-1216-FNPR	12	19.0	3/4	5075	20300	NPTF	1-11 1/2	48.0	42.0	93.0	156.00
QFF-1616-FNPR	16	25.0	1	5075	20300	NPTF	1-11 1/2	55.0	50.0	101.0	177.00
QFF-1620-FNPR	16	25.0	1	5075	20300	NPTF	1 1/4-11 1/2	55.0	50.0	101.0	177.00
QFF-0404-FORB	04	6.0	1/4	5075	20300	SAE-OB	7/16-20	26.0	22.0	57.8	97.00
QFF-0406-FORB	04	6.0	1/4	5075	20300	SAE-OB	9/16-18	26.0	22.0	57.8	97.00
QFF-0606-FORB	06	10.0	3/8	5075	20300	SAE-OB	9/16-18	32.0	27.0	71.3	119.00
QFF-0608-FORB	06	10.0	3/8	5075	20300	SAE-OB	3/4-16	32.0	27.0	72.3	121.00
QFF-0808-FORB	08	13.0	1/2	5075	20300	SAE-OB	3/4-16	38.0	32.0	74.5	125.00
QFF-0810-FORB	08	13.0	1/2	5075	20300	SAE-OB	7/8-14	38.0	32.0	74.5	125.00
QFF-0812-FORB	08	13.0	1/2	5075	20300	SAE-OB	1 1/16-12	38.0	32.0	80.5	137.00
QFF-1012-FORB	10	16.0	5/8	5075	20300	SAE-OB	1 1/16-12	40.0	34.0	90.3	153.00
QFF-1212-FORB	12	19.0	3/4	5075	20300	SAE-OB	1 1/16-12	48.0	42.0	95.5	160.50
QFF-1216-FORB	12	19.0	3/4	5075	20300	SAE-OB	1 5/16-12	48.0	42.0	97.5	164.50
QFF-1616-FORB	16	25.0	1	5075	20300	SAE-OB	1 5/16-12	55.0	50.0	107.3	185.30
QFF-1620-FORB	16	25.0	1	5075	20300	SAE-OB	1 5/8-12	55.0	50.0	109.3	187.30

NPTF connection according to ANSI B1-20.3, SAE UNF/UN connection according to SAE J 1926-1. Other threads available. Please consult factory.

STANDARD ISO 16028 - FLAT FACE QF

Male coupling - Female thread

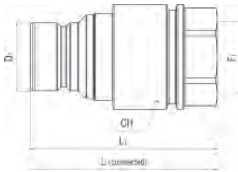

Item Code	⊗			Working Pressure (psi)	Burst Pressure (psi)	Thread 1	F1	D1	CH	L1	L
	Dash	(mm)	(in)					(mm)	(mm)	(mm)	(mm)
QFM-0404-FNPR	04	6.0	1/4	5075	20300	NPTF	1/4-18	16.2	20.0	50.5	97.00
QFM-0606-FNPR	06	10.0	3/8	5075	20300	NPTF	3/8-18	19.7	27.0	64.0	117.00
QFM-0608-FNPR	06	10.0	3/8	5075	20300	NPTF	1/2-14	19.7	27.0	64.0	117.00
QFM-0808-FNPR	08	13.0	1/2	5075	20300	NPTF	1/2-14	24.6	32.0	68.0	125.00
QFM-0812-FNPR	08	13.0	1/2	5075	20300	NPTF	3/4-14	24.6	32.0	68.0	125.00
QFM-1012-FNPR	10	16.0	5/8	5075	20300	NPTF	3/4-14	27.0	34.0	70.0	134.00
QFM-1212-FNPR	12	19.0	3/4	5075	20300	NPTF	3/4-14	29.9	42.0	85.0	156.00
QFM-1216-FNPR	12	19.0	3/4	5075	20300	NPTF	1-11 1/2	29.9	42.0	85.0	156.00
QFM-1616-FNPR	16	25.0	1	5075	20300	NPTF	1-11 1/2	36.0	50.0	99.0	177.00
QFM-1620-FNPR	16	25.0	1	5075	20300	NPTF	1 1/4-11 1/2	36.0	50.0	99.0	177.00
QFM-0404-FORB	04	6.0	1/4	5075	20300	SAE-OB	7/16-20	16.2	20.0	50.5	97.00
QFM-0406-FORB	04	6.0	1/4	5075	20300	SAE-OB	9/16-18	16.2	20.0	50.5	97.00
QFM-0606-FORB	06	10.0	3/8	5075	20300	SAE-OB	9/16-18	19.7	27.0	64.0	119.00
QFM-0608-FORB	06	10.0	3/8	5075	20300	SAE-OB	3/4-16	19.7	27.0	65.0	121.00
QFM-0808-FORB	08	13.0	1/2	5075	20300	SAE-OB	3/4-16	24.6	32.0	72.0	125.00
QFM-0810-FORB	08	13.0	1/2	5075	20300	SAE-OB	7/8-14	24.6	32.0	72.0	125.00
QFM-0812-FORB	08	13.0	1/2	5075	20300	SAE-OB	1 1/16-12	24.6	32.0	78.0	137.00
QFM-1012-FORB	10	16.0	5/8	5075	20300	SAE-OB	1 1/16-12	27.0	34.0	80.0	153.00
QFM-1212-FORB	12	19.0	3/4	5075	20300	SAE-OB	1 1/16-12	29.9	42.0	87.0	160.50
QFM-1216-FORB	12	19.0	3/4	5075	20300	SAE-OB	1 5/16-12	29.9	42.0	89.0	164.50
QFM-1616-FORB	16	25.0	1	5075	20300	SAE-OB	1 5/16-12	36.0	50.0	99.0	185.30
QFM-1620-FORB	16	25.0	1	5075	20300	SAE-OB	1 5/8-12	55.0	50.0	109.3	187.30

NPTF connection according to ANSI B1-20.3, SAE UNF/UN connection according to SAE J 1926-1. Other threads available. Please consult factory.

Because we continually examine ways to improve our products, we reserve the right to alter specifications or discontinue products without prior notice.

Quick Disconnect



HOSES
ONE-PIECE B SERIES
ONE-PIECE D SERIES
ONE-PIECE F & P SERIES
TWO-PIECE FERRULES (A & PFR SERIES)
TWO-PIECE INSERTS (A SERIES)
TWO-PIECE INTERLOCK FERRULES & INSERTS (X & Z SERIES)
QUICK RELEASE
ASSEMBLY EQUIPMENT
TECHNICAL INFORMATION

QG

FLAT FACE STANDARD ISO 16028

TOP COAT

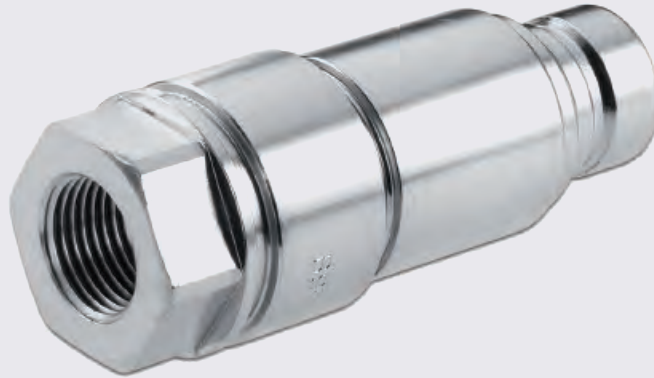

PATENT PENDING



DN 10 to 19
3/8" to 3/4"



WP 350 bar
5075 PSI

- Connectable under pressure with patented system
- Low effort to connect under pressure
- Robust, compact and light weight
- Low leak-oil rates, eco-friendly
- Low pressure drop

General features: connectable under pressure ARGUS QG flat face quick release couplings are used for quick coupling and uncoupling of hydraulic lines. During the coupling action in zero or low-pressure ranges, valves that release or block the flow are automatically activated. The QG flat face quick release coupling, formed by a coupling plug and a coupling socket, is coupled by pushing on a sleeve. This guarantees a flush connection between the two coupling halves. The sleeve is designed to be moved in the relevant direction for disconnecting or connecting the coupling halves.

Materials: galvanized steel with hardened parts subject to wear. HNBR seals (other materials on request) - backup rings PTFE - Thermoplastic dust cap and dust plug. Top Coat Cr-III zinc plating with additional trivalent passivation for outstanding surface protection.

Application: suitable for liquid lines with mineral oil-based hydraulic fluids to DIN 51524 T1+T2. Also available for flame-resistant hydraulic fluids to VDMA 24317, for pneumatic and water hydraulics in appropriate materials on request.

Norm: ISO 16028

Temperature range:
-22°F (-30°C) to +257°F (+125°C)

Note: rated flow / pressure drop values on request.

Other sizes and connection types available on request.

Specific instructions for installation, use and maintenance are separately provided.

Because we continually examine ways to improve our products, we reserve the right to alter specifications or discontinue products without prior notice.



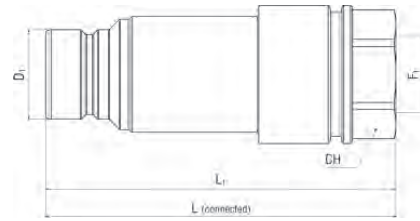

STANDARD ISO 16028 - FLAT FACE QG CONNECTABLE UNDER PRESSURE

Male coupling - Female thread

Item Code				Working Pressure (psi)	Burst Pressure (psi)	Thread 1	F1	D1	CH	L1	L
	Dash	(mm)	(in)					(mm)	(mm)	(mm)	(mm)
QG-0606-FNPR	06	10.0	3/8	5075	20300	NPTF	3/8-18	19.7	27.0	82.5	134.00
QG-0808-FNPR	08	13.0	1/2	5075	20300	NPTF	1/2-14	24.6	32.0	94.5	152.00
QG-1212-FNPR	12	19.0	3/4	5075	20300	NPTF	3/4-14	29.9	42.0	118.5	189.50

NPTF connection according to ANSI B1-20.3.
Other threads available. Please consult factory.

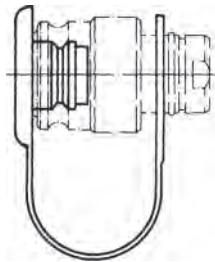

STANDARD ISO 16028 - FLAT FACE QF

Dust cap for female coupling

Item Code	Color	Material			
			Dash	(mm)	(in)
QFP-04	RED	PE	04	6.0	1/4
QFP-06	RED	PE	06	10.0	3/8
QFP-08	RED	PE	08	13.0	1/2
QFP-10	RED	PE	10	16.0	5/8
QFP-12	RED	PE	12	19.0	3/4
QFP-16	RED	PE	16	25.0	1

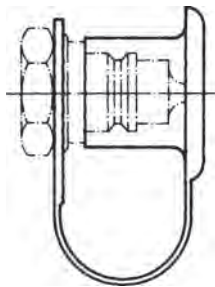

STANDARD ISO 16028 - FLAT FACE QF

Dust cap for male coupling

Item Code	Color	Material			
			Dash	(mm)	(in)
QFC-04	RED	PE	04	6.0	1/4
QFC-06	RED	PE	06	10.0	3/8
QFC-08	RED	PE	08	13.0	1/2
QFC-10	RED	PE	10	16.0	5/8
QFC-12	RED	PE	12	19.0	3/4
QFC-16	RED	PE	16	25.0	1

Because we continually examine ways to improve our products, we reserve the right to alter specifications or discontinue products without prior notice.

Quick Disconnect



HOSES
ONE-PIECE B SERIES
ONE-PIECE D SERIES
ONE-PIECE F & P SERIES
TWO-PIECE FERRULES (A & PFR SERIES)
TWO-PIECE INSERTS (A SERIES)
TWO-PIECE INTERLOCK FERRULES & INSERTS (X & Z SERIES)
QUICK RELEASE
ASSEMBLY EQUIPMENT
TECHNICAL INFORMATION

QS

SCREW TYPE FLAT FACE

TOP COAT



PATENT PENDING



DN 10 to 25
3/8" to 1"



to max WP 450 bar
6525 PSI

- Very low leak-oil rates, eco-friendly
- Highly robust construction
- Low pressure drop
- Locking system for safety purposes

General features: ARGUS QS quick release couplings enable oil leak-free connection and disconnection of hydraulic lines. Their robust construction and tested components make them ideally suited for high and intermittent pressure loads. During the coupling action, valves that release and/or block the flow are automatically activated. The QS quick release coupling, formed by coupling plug and coupling socket, is coupled by a screwing action with the hand nut of the plug component.

Materials: galvanized steel - Brass valve stem guide - HNBR O-rings (other materials optional). Top Coat Cr-III zinc plating with additional trivalent passivation for outstanding surface protection.

Application: suitable for liquid lines with mineral oil-based hydraulic fluids to DIN 51524 and DIN 51525. Also available for flame-resistant hydraulic fluids to VDMA 24317, for pneumatics and water hydraulics in appropriate materials on request.

Temperature range:
-22°F (-30°C) to +257°F (+125°C)

Note: other sizes and connection types available on request.

Specific instructions for installation, use and maintenance are separately provided.

Because we continually examine ways to improve our products, we reserve the right to alter specifications or discontinue products without prior notice.



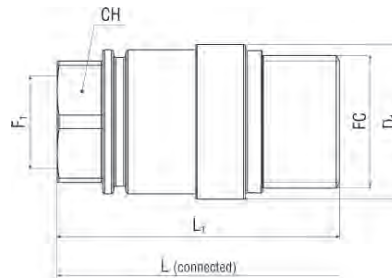

SCREW COUPLING - FLAT FACE QS

Female coupling - Female thread

Item Code				Working Pressure Conn. (psi)	Working Pressure Disconn. (psi)	Thread 1	F1	FC	D1 (mm)	CH (mm)	L1 (mm)	L (mm)
	Dash	(mm)	(in)									
QSF-0606-FNPR	06	10.0	3/8	6525	5075	NPTF	3/8-18	M28x2	34.8	27.0	69.3	117.40
QSF-0808-FNPR	08	13.0	1/2	6525	5075	NPTF	1/2-14	M35x3	40.8	32.0	74.5	127.40
QSF-1012-FNPR	10	16.0	5/8	6525	5075	NPTF	3/4-14	M38x3	43.8	34.0	81.3	133.50
QSF-1212-FNPR	12	19.0	3/4	6525	5075	NPTF	3/4-14	M43x3	51.0	42.0	93.0	156.00
QSF-1616-FNPR	16	25.0	1	5800	5075	NPTF	1-11 1/2	M52x4	59.8	50.0	101.0	176.90
QSF-1620-FNPR	16	25.0	1	5800	5075	NPTF	1 1/4-11 1/2	M52x4	59.8	50.0	101.0	176.90

NPTF connection according to ANSI B1-20.3.
Other threads available. Please consult factory.

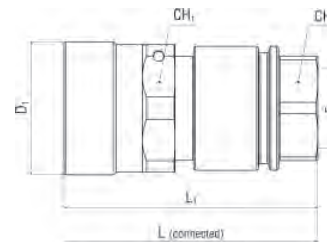

SCREW COUPLING - FLAT FACE QS

Male coupling - Female thread

Item Code				Working Pressure Conn. (psi)	Working Pressure Disconn. (psi)	Thread 1	F1	D1 (mm)	CH (mm)	CH1 (mm)	L1 (mm)	L (mm)
	Dash	(mm)	(in)									
QSM-0606-FNPR	06	10.0	3/8	6525	5075	NPTF	3/8-18	33.8	33.0	27.0	70.6	117.40
QSM-0808-FNPR	08	13.0	1/2	6525	5075	NPTF	1/2-14	40.8	39.0	32.0	77.7	127.40
QSM-1012-FNPR	10	16.0	5/8	6525	5075	NPTF	3/4-14	43.8	34.0	42.0	78.5	133.50
QSM-1212-FNPR	12	19.0	3/4	6525	5075	NPTF	3/4-14	51.2	50.0	42.0	94.3	156.00
QSM-1616-FNPR	16	25.0	1	5800	5075	NPTF	1-11 1/2	59.8	60.0	50.0	108.7	176.90
QSM-1620-FNPR	16	25.0	1	5800	5075	NPTF	1 1/4-11 1/2	59.8	60.0	50.0	108.7	176.90

NPTF connection according to ANSI B1-20.3.
Other threads available. Please consult factory.

Because we continually examine ways to improve our products, we reserve the right to alter specifications or discontinue products without prior notice.

Quick Disconnect



HOSES
ONE-PIECE B SERIES
ONE-PIECE D SERIES
ONE-PIECE F & P SERIES
TWO-PIECE FERRULES (A & PFR SERIES)
TWO-PIECE INSERTS (A SERIES)
TWO-PIECE INTERLOCK FERRULES & INSERTS (X & Z SERIES)
QUICK RELEASE
ASSEMBLY EQUIPMENT
TECHNICAL INFORMATION

QK

SCREW TYPE FLAT FACE

TOP COAT



PATENT PENDING



DN 10 to 25
3/8" to 1"



to max WP 450 bar
6525 PSI

- Connectable under pressure with patented system
- Very low leak-oil rates, eco-friendly
- Highly robust construction
- Low pressure drop
- Locking system for safety purposes

General features: connectable under pressure ARGUS QK quick release couplings enable oil leak-free connection and disconnection of hydraulic lines. Their robust construction and tested components make them ideally suited for high and intermittent pressure loads. During the coupling action, valves that release and/or block the flow are automatically activated. The QK quick release coupling, formed by coupling plug and coupling socket, is coupled by a screwing action with the hand nut of the plug component.

Materials: galvanized steel - Brass valve stem guide - HNBR O-rings (other materials optional). Top Coat Cr-III zinc plating with additional trivalent passivation for outstanding surface protection.

Application: suitable for liquid lines with mineral oil-based hydraulic fluids to DIN 51524 and DIN 51525. Also available for flame-resistant hydraulic fluids to VDMA 24317, for pneumatics and water hydraulics in appropriate materials on request.

Temperature range:
-22°F (-30°C) to +257°F (+125°C)

Note: other sizes and connection types available on request.

Specific instructions for installation, use and maintenance are separately provided.

Because we continually examine ways to improve our products, we reserve the right to alter specifications or discontinue products without prior notice.



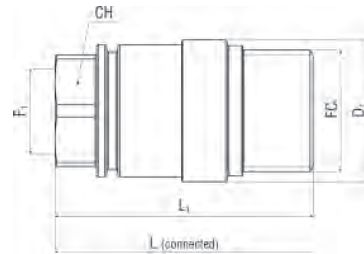

SCREW COUPLING - FLAT FACE QK CONNECTABLE UNDER PRESSURE

Female coupling - Female thread

Item Code				Working Pressure Conn. (psi)	Working Pressure Disconn. (psi)	Thread 1	F1	FC	D1	CH	L1
	Dash	(mm)	(in)						(mm)	(mm)	(mm)
QKF-0606-FNPR	06	10.0	3/8	6525	5075	NPTF	3/8-18	M28x2	34.8	27.0	69.3
QKF-0808-FNPR	08	13.0	1/2	6525	5075	NPTF	1/2-14	M35x3	40.8	32.0	74.5
QKF-1012-FNPR	10	16.0	5/8	6525	5075	NPTF	3/4-14	M38x3	43.8	34.0	81.3
QKF-1212-FNPR	12	19.0	3/4	6525	5075	NPTF	3/4-14	M43x3	51.0	42.0	93.0
QKF-1616-FNPR	16	25.0	1	6525	5075	NPTF	1-11 1/2	M52x4	59.8	50.0	101.0
QKF-1620-FNPR	16	25.0	1	6525	5075	NPTF	1 1/4-11 1/2	M52x4	59.8	50.0	101.0

NPTF connection according to ANSI B1-20.3.
Other threads available. Please consult factory.

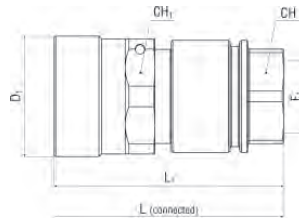

SCREW COUPLING - FLAT FACE QK CONNECTABLE UNDER PRESSURE

Male coupling - Female thread

Item Code				Working Pressure Conn. (psi)	Working Pressure Disconn. (psi)	Thread 1	F1	D1	CH	CH1	L1
	Dash	(mm)	(in)					(mm)	(mm)	(mm)	(mm)
QKM-0606-FNPR	06	10.0	3/8	6525	5075	NPTF	3/8-18	33.8	33.0	27.0	97.1
QKM-0808-FNPR	08	13.0	1/2	6525	5075	NPTF	1/2-14	40.8	39.0	32.0	107.0
QKM-1012-FNPR	10	16.0	5/8	6525	5075	NPTF	3/4-14	43.8	34.0	42.0	117.8
QKM-1212-FNPR	12	19.0	3/4	6525	5075	NPTF	3/4-14	51.2	50.0	42.0	127.8
QKM-1616-FNPR	16	25.0	1	6525	5075	NPTF	1-11 1/2	59.8	60.0	50.0	137.0
QKM-1620-FNPR	16	25.0	1	6525	5075	NPTF	1 1/4-11 1/2	59.8	60.0	50.0	137.0

NPTF connection according to ANSI B1-20.3.
Other threads available. Please consult factory.

HOSES

ONE-PIECE
B SERIES

ONE-PIECE
D SERIES

ONE-PIECE
F & P SERIES

TWO-PIECE FERRULES
(A & PFR SERIES)

TWO-PIECE INSERTS
(A SERIES)

TWO-PIECE INTERLOCK
FERRULES & INSERTS
(X & Z SERIES)

QUICK
RELEASE

ASSEMBLY
EQUIPMENT

TECHNICAL
INFORMATION

Because we continually examine ways to improve our products, we reserve the right to alter specifications or discontinue products without prior notice.

HOSES
ONE-PIECE B SERIES
ONE-PIECE D SERIES
ONE-PIECE F & P SERIES
TWO-PIECE FERRULES (A & PFR SERIES)
TWO-PIECE INSERTS (A SERIES)
TWO-PIECE INTERLOCK FERRULES & INSERTS (X & Z SERIES)
QUICK RELEASE
ASSEMBLY EQUIPMENT

QX

SCREW TYPE POPPET STANDARD ISO 14540

TOP COAT



DN 6 to 10
1/4" to 3/8"



WP 700 bar
10150 PSI

- Typically employed in power tools
- Compatibility with other couplings in-use

General features: ARGUS QX high pressure couplings can be used for connecting and disconnecting hydraulic lines. Their robust construction and tested components make them ideally suited for high and intermittent pressure loads. During the coupling action, valves that release and/or block the flow are automatically activated. The QX quick release coupling, formed by coupling plug and coupling socket, is coupled by a screwing action with the hand nut of the plug component.

Materials: galvanized steel - HNBR O-rings (other materials optional) - Thermoplastic dust cap and dust plug. Top Coat Cr-III zinc plating with additional trivalent passivation for outstanding surface protection.

Application: suitable for liquid lines with mineral oil-based hydraulic fluids to DIN 51524 T1+T2.

Norm: ISO 14540

Temperature range:
-22°F (-30°C) to +257°F (+125°C)

Note: rated flow / pressure drop values on request.

Other sizes and connection types available on request.

Specific instructions for installation, use and maintenance are separately provided.

Because we continually examine ways to improve our products, we reserve the right to alter specifications or discontinue products without prior notice.

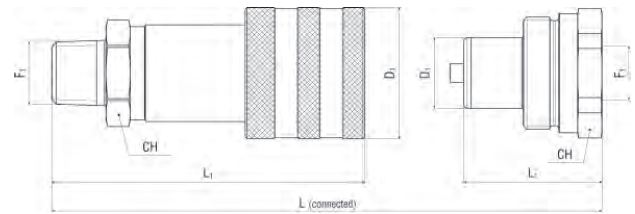

SCREW COUPLING - POPPET QX

Female coupling - Male thread

Item Code				Working Pressure (psi)	Burst Pressure (psi)	Thread 1	F1	D1	CH	L1	L
	Dash	(mm)	(in)					(mm)	(mm)	(mm)	(mm)
QXF-0404-MNPT	04	6.0	1/4	10150	40600	NPTF	1/4-18	28.5	22.0	59.6	74.00
QXF-0606-MNPT	06	10.0	3/8	10150	40600	NPTF	3/8-18	35.0	25.0	72.5	83.00

NPTF connection according to ANSI B1-20.3.

SCREW COUPLING - POPPET QX

Male coupling - Female thread

Item Code				Working Pressure (psi)	Burst Pressure (psi)	Thread 1	F1	D1	CH	L1	L
	Dash	(mm)	(in)					(mm)	(mm)	(mm)	(mm)
QXM-0404-FNPR	04	6.0	1/4	10150	40600	NPTF	1/4-18	15.8	19.0	32.5	74.00
QXM-0606-FNPR	06	10.0	3/8	10150	40600	NPTF	3/8-18	19.0	32.0	35.0	83.00

NPTF connection according to ANSI B1-20.3.

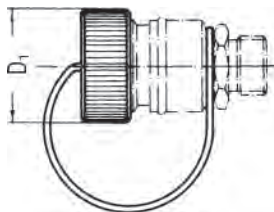

SCREW COUPLING - POPPET QX

Dust cap for female coupling

Item Code	Color	Material				D1
			Dash	(mm)	(in)	(mm)
QXC-04	BLK	PE	04	6.0	1/4	23.0
QXC-06	BLK	PE	06	10.0	3/8	27.0

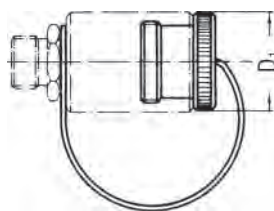

SCREW COUPLING - POPPET QX

Dust plug for male coupling

Item Code	Color	Material				D1
			Dash	(mm)	(in)	(mm)
QXP-04	BLK	PE	04	6.0	1/4	25.0
QXP-06	BLK	PE	06	10.0	3/8	30.0

Because we continually examine ways to improve our products, we reserve the right to alter specifications or discontinue products without prior notice.

HOSES
 ONE-PIECE B SERIES
 ONE-PIECE D SERIES
 ONE-PIECE F & P SERIES
 TWO-PIECE FERRULES (A & PFR SERIES)
 TWO-PIECE INSERTS (A SERIES)
 TWO-PIECE INTERLOCK FERRULES & INSERTS (X & Z SERIES)
 QUICK RELEASE
 ASSEMBLY EQUIPMENT
 TECHNICAL INFORMATION

QM MULTI-COUPLING

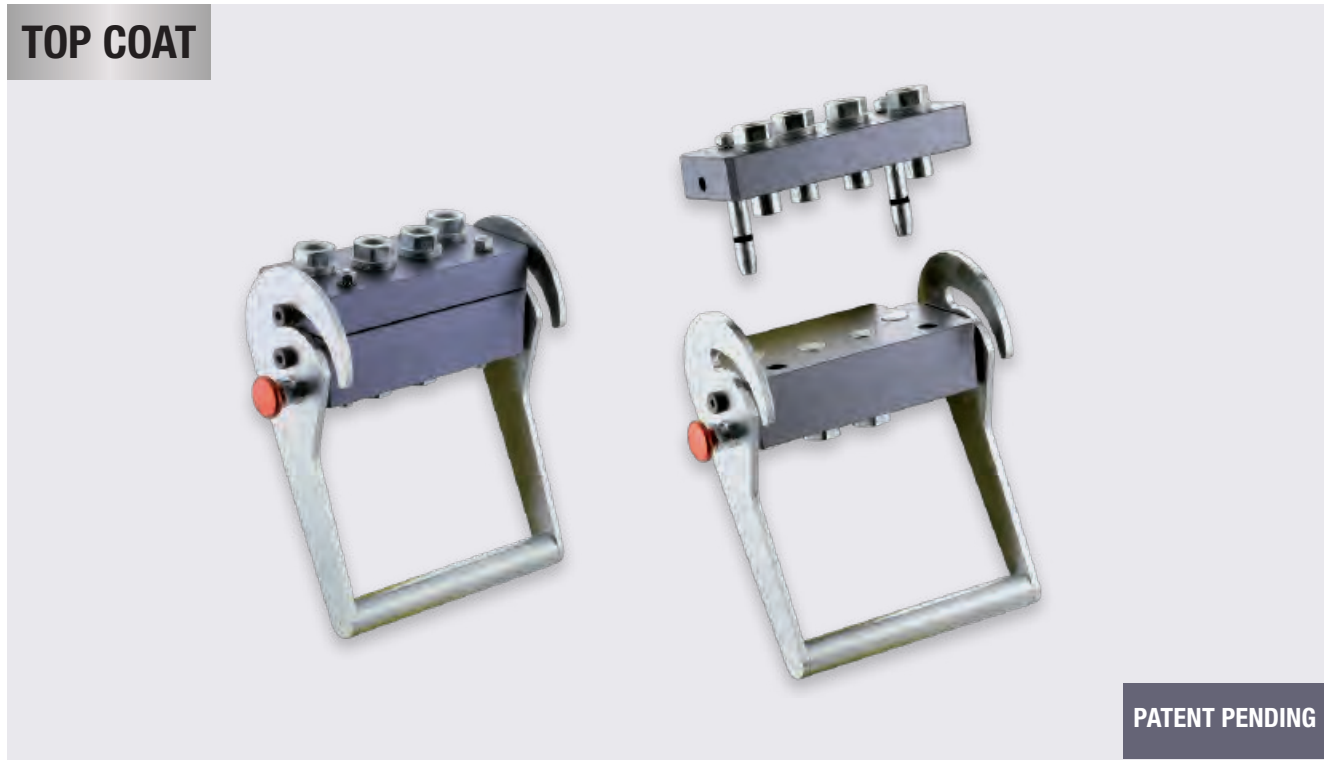

PATENT PENDING

DN 10 to 19
 3/8" to 3/4"

WP 250 bar
 3625 PSI

- Tailor-made according to customer's needs
- Compact, reliable and safe

General features: ARGUS multi-couplings, which consist of a fixed and a mobile part, are developed following the specific needs of the user. The multi-connection plates are obtained from an anodized aluminium block as standard, and include the locations for flat-face couplings built of carbon steel with TOP COAT surface protection, but every component can be manufactured in different materials on request. The number of lines and possible electric or pneumatic connections can be defined depending on the application requirements. Connecting and disconnecting are carried out by means of a cam leverage group with guiding

pins, and a safety device is always present. Hose connections can be executed with threads of every type (e.g. BSP, NPT, SAE, metric) or also with the quick connect system "Plug-In Connector".

Note: a complete range of spare parts and accessories are available specific instructions for installation, use and maintenance are separately provided.

Because we continually examine ways to improve our products, we reserve the right to alter specifications or discontinue products without prior notice.

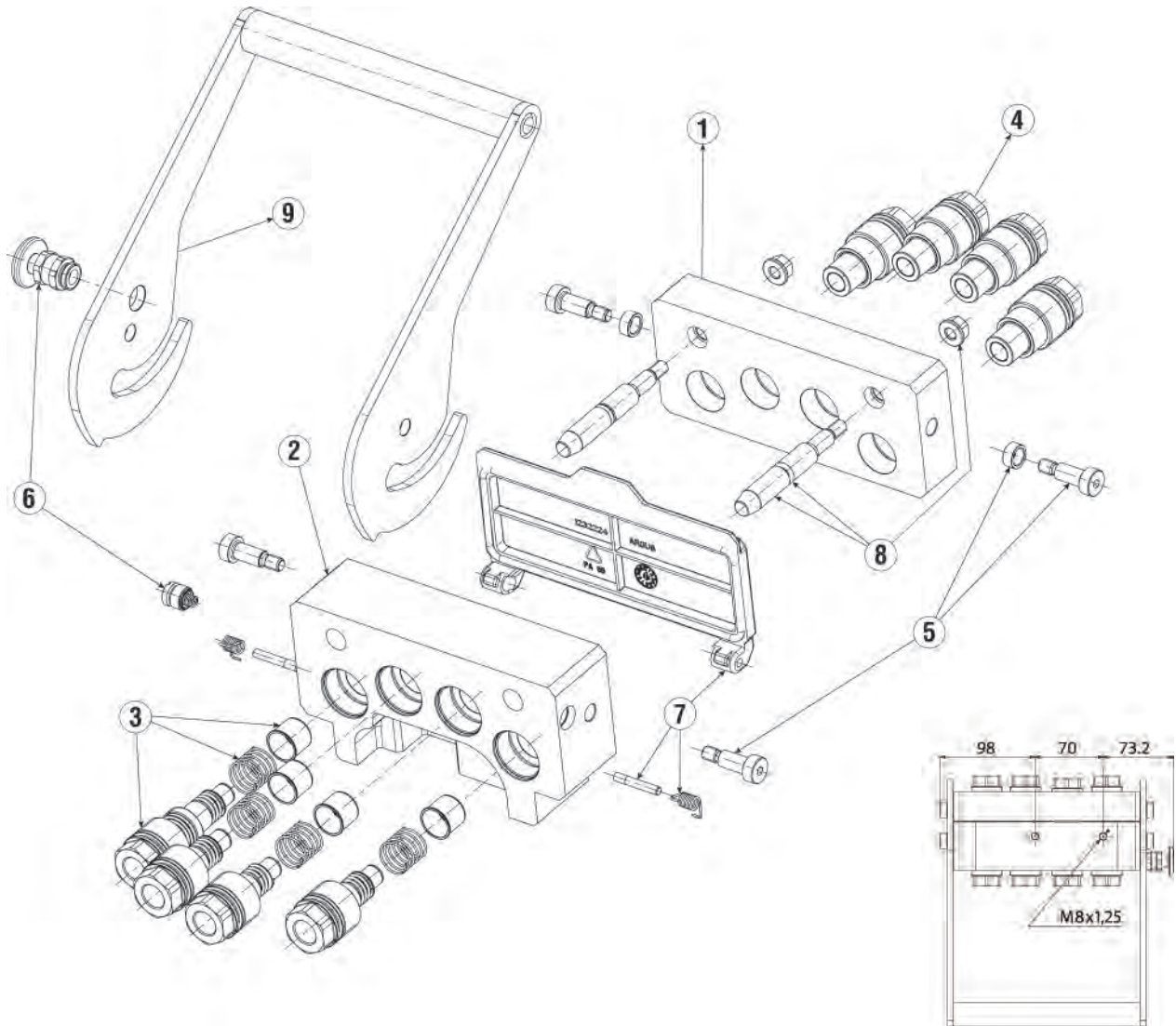

Pos.	Description	Multi-k	Multi-k
		4x3/8"	4x1/2"
		Part Number	Part Number
1	Mobile plate	1232208	1236572
2	Fixed plate	1232209	1233705
3	Female coupling	1232275	1233168
4	Male coupling	1232278	1236574
5	Screw group	1232282	1232282
6	Safetely lock group	1232280	1232280
7	Cover group	1232276	1232276
8	Guide pin group	1232281	1232281
9	Lever group	1233171	1233171

COMPONENTS AND MATERIALS

- Mobile and fixed plate in anodized aluminium 6082
- Quick release coupling in steel with galvanic protection
- Seal and back-up ring in NBR and PTFE
- Springs according to EN 102070-1
- Lock lever in steel with galvanic protection
- Safetely block in steel and aluminium

Because we continually examine ways to improve our products, we reserve the right to alter specifications or discontinue products without prior notice.

- HOSES
- ONE-PIECE B SERIES
- ONE-PIECE D SERIES
- ONE-PIECE F & P SERIES
- TWO-PIECE FERRULES (A & PFR SERIES)
- TWO-PIECE INSERTS (A SERIES)
- TWO-PIECE INTERLOCK FERRULES & INSERTS (X & Z SERIES)
- QUICK RELEASE
- ASSEMBLY EQUIPMENT
- TECHNICAL INFORMATION

FLOW RATE TABLE

QA Series ISO-A POPPET STANDARD ISO 7241 A

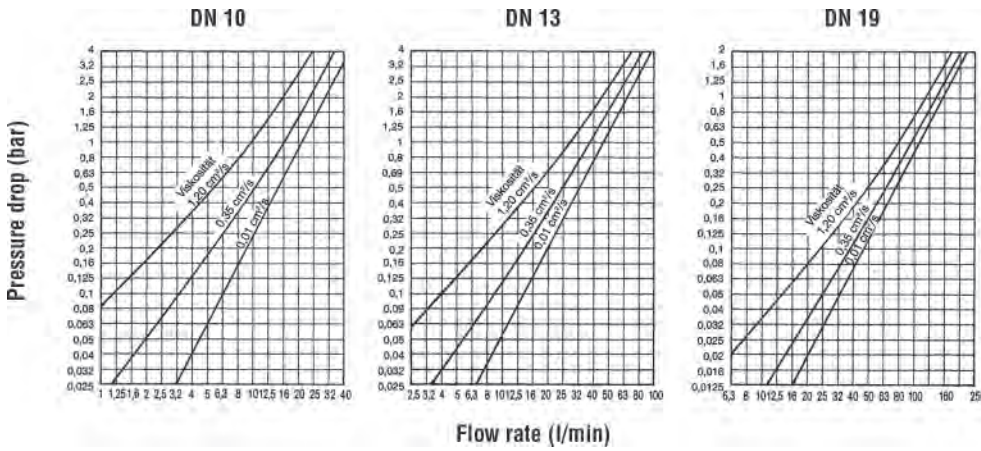

Because we continually examine ways to improve our products, we reserve the right to alter specifications or discontinue products without prior notice.

QF Series

FLAT FACE STANDARD ISO 16028



DN 6 TO 25



TO MAX. WP 350 BAR

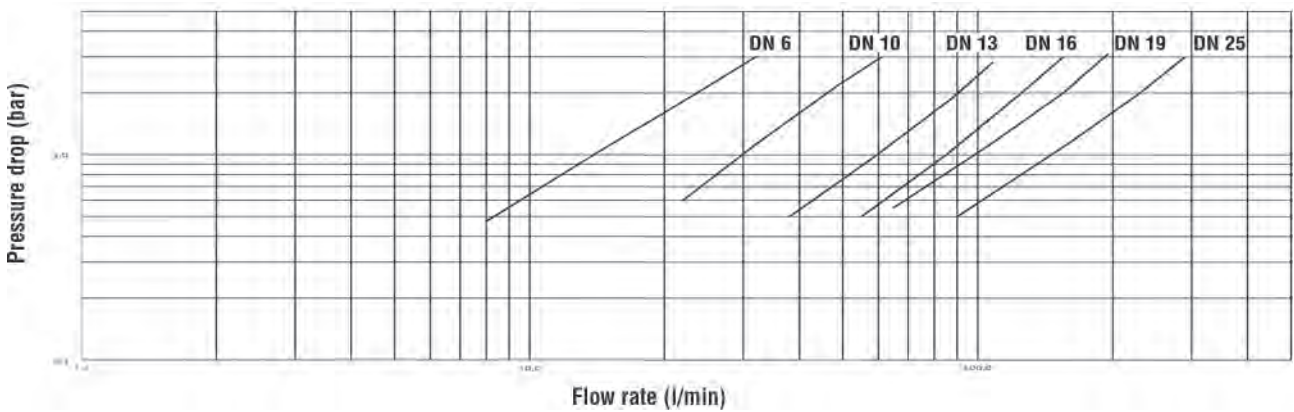

QS Series

SCREW TYPE FLAT FACE



DN 10 TO 25



TO MAX. WP 150 BAR

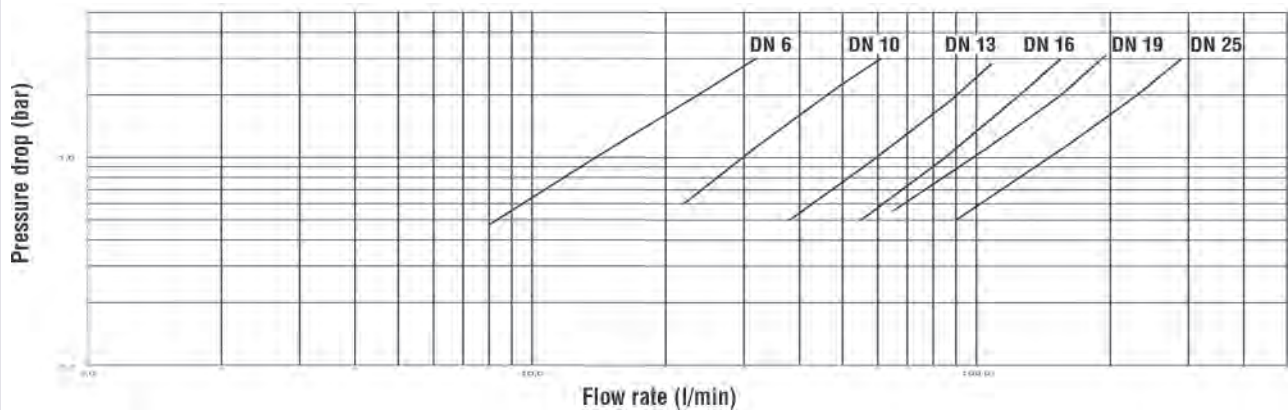

Because we continually examine ways to improve our products, we reserve the right to alter specifications or discontinue products without prior notice.

HOSES

ONE-PIECE
B SERIES

ONE-PIECE
D SERIES

ONE-PIECE
F & P SERIES

TWO-PIECE FERRULES
(A & PFR SERIES)

TWO-PIECE INSERTS
(A SERIES)

TWO-PIECE INTERLOCK
FERRULES & INSERTS
(X & Z SERIES)

QUICK
RELEASE

ASSEMBLY
EQUIPMENT

TECHNICAL
INFORMATION

Assembly Equipment and Accessories

Service Crimpers

KC1-H47E	274	KD165	277
KC1-H47PI	276		
KC1-H47PM	275		

Standard Volume Crimpers

Dies	284	KC3-H88	279
ES3 Electronic Controllers	285	KC3-H135	283
KC1-H83	278	KC3-H170	282
KC1-H135	281	KC3-HS54	280

KuriSaws™ Hose Cutters

KCS-TF1/E-110/1	286
KCS-TF2/E-230/1	287
KCS-TF3/E-230/1	287

Skiving Equipment

KSKIVE1	288
KSKIVE2	288

Accessories/Hose Protectors

Floppy Guard Metal Hose - HTG1100, HTS1100	291
Nylon Sleeve Guard	290
Plastic Coil Sleeve – PCG	290

Steel Coil Springs – SRS	289
Steel Flat Coil Sleeve – SSF	289

Because we continually examine ways to improve our products, we reserve the right to alter specifications or discontinue products without prior notice.



Service and Standard Crimper Choices Based on Maximum Hose Capacity Information



KC1-H47E KC1-H47PM KC1-H47PI KD165 KC1-H83 KC3-H88

Crimping Force (ton)	110	110	110	62	150	150
Max. Opening with Dies (mm / in)	49 / 1.93	49 / 1.93	49 / 1.93	N/A	96 / 3.78	102 / 4.02
Max. Capacity 1-2 Wire Braided (in)	1	1	1	1 1/4	1 1/2	1 1/2
Max. Capacity 4 Spiral (in)	NA	NA	NA	1 1/4**	1 1/4	1 1/4
Max. Capacity 6 Spiral (in)	NA	NA	NA	NA	1	1
Max. Capacity Industrial (in)	NA	NA	NA	NA	1 1/2	1 1/2
Power	Hand or Air	Hand	Air	1 HP (110 V)	4.0 HP (230 V)	4.0 HP (230 V)
Controller	Dial Micrometer	Dial Micrometer	Dial Micrometer	Dial Micrometer	Dial Micrometer	ES3

** 1 1/4" up to 3,000 PSI, 1" up to 4,000 PSI



KC3-HS54 KC1-H135 KC3-H135 KC3-H170 KC3-H144

Crimping Force (ton)	76	330	330	308	440
Max. Opening with Dies (mm / in)	108 / 4.25	139 / 5.47	139 / 5.47	192 / 7.56	176 / 6.93
Max. Capacity 1-2 Wire Braided (in)	2	2	2	2	2 1/2
Max. Capacity 4 Spiral (in)	2	2	2	2	2 1/2
Max. Capacity 6 Spiral (in)	1 1/4	2	2	2*	2
Max. Capacity Industrial (in)	3	3	3	4	4
Power	2.9 HP (230 V)	7.5 HP** (230 V)	7.5 HP (230 V)	7 HP (230 V)	7.5 HP (230 V)
Controller	ES3	Dial Micrometer	ES3	ES3	ES3

* Limited to 5,000 PSI Alfagomma hose using 1-pc fittings

** 5.5 HP for single phase

Because we continually examine ways to improve our products, we reserve the right to alter specifications or discontinue products without prior notice.

HOSES
ONE-PIECE B SERIES
ONE-PIECE D SERIES
ONE-PIECE F & P SERIES
TWO-PIECE FERRULES (A & PFR SERIES)
TWO-PIECE INSERTS (A SERIES)
TWO-PIECE INTERLOCK FERRULES & INSERTS (X & Z SERIES)
QUICK RELEASE
ASSEMBLY EQUIPMENT
TECHNICAL INFORMATION

KC1-H47E Series



Description: With its built-in carrying handle, and weighing a mere 64 lbs., the KC1-H47E is a crimping on the go, perfect for on-site service in remote areas. It's powered by either a separate hand or pneumatic pump.

Included Accessories:

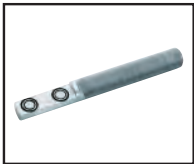

Die Change Tool
KCDCT-H39



Carry Handle

Optional Accessories:



Hand Pump
KC1-H47E-HP



Air Pump
KC1-H47E-PAP



Support Frame
KC1-H47E-BASE



Custom Made Dies



Frame sold separately

Hose Capacity (in)		Crimping Force (ton)
1 - 2 Wire	1	110
4 SP / 6 SP	NA	
90° Fittings	3/8	
Industrial	NA	

Opening Diameter	
Max. With Dies (mm / in)	49 / 1.93
By Die Size (mm)	Die Size + 20

Crimper Size	
L x W x H (in)	7.87 x 12.36 x 12.60
Weight (lbs)	64

Part Number	Pump Info
KC1-H47E	Hand or Air

Control Mechanism:



Dial micrometer, with electric limit switch indicating when the crimp diameter is reached.

Die Series	Die Range (mm)			
H39	6 - 29			
Die Number	Crimp Range (mm)	Closed Diameter (mm)	Length (mm)	Weight (lbs/ea)
KCDH39-06	6.0 - 8.0	6	55	4.0
KCDH39-08	8.0 - 10.0	8	55	4.0
KCDH39-10	10.0 - 12.0	10	55	4.0
KCDH39-12	12.0 - 14.0	12	55	4.0
KCDH39-14	14.0 - 16.0	14	55	4.0
KCDH39-16	16.0 - 19.0	16	55	4.0
KCDH39-19	19.0 - 22.0	19	55	4.0
KCDH39-22	22.0 - 25.0	22	55	4.0
KCDH39-25	25.0 - 29.0	25	65	4.0
KCDH39-29	29.0 - 34.0	29	65	4.0

Because we continually examine ways to improve our products, we reserve the right to alter specifications or discontinue products without prior notice.

Hose Capacity (in)		Crimping Force (ton)
1 – 2 Wire	1	110
4 SP / 6 SP	NA	
90° Fittings	3/8	
Industrial	NA	

Opening Diameter	
Max. With Dies (mm / in)	49 / 1.93
By Die Size (mm)	Die Size + 20

Crimper Size	
L x W x H (in)	15.4 x 20.7 x 11.8
Weight (lbs)	71

Part Number	Pump Info
KC1-H47PM	Hand

Control Mechanism:



Dial micrometer, with electric limit switch indicating when the crimp diameter is reached.

Die Series		Die Range (mm)			
H39		6 – 29			
Die Number	Crimp Range (mm)	Closed Diameter (mm)	Length (mm)	Weight (lbs/ea)	
KCDH39-06	6.0 - 8.0	6	55	4.0	
KCDH39-08	8.0 - 10.0	8	55	4.0	
KCDH39-10	10.0 - 12.0	10	55	4.0	
KCDH39-12	12.0 - 14.0	12	55	4.0	
KCDH39-14	14.0 - 16.0	14	55	4.0	
KCDH39-16	16.0 - 19.0	16	55	4.0	
KCDH39-19	19.0 - 22.0	19	55	4.0	
KCDH39-22	22.0 - 25.0	22	55	4.0	
KCDH39-25	25.0 - 29.0	25	65	4.0	
KCDH39-29	29.0 - 34.0	29	65	4.0	

KC1-H47PM Series



Description: Looking for a reliable crimping tool that won't take up a lot of space? With its small footprint the KC1-H47PM is a perfect fit for crowded shops. Its small size also makes it good for quick trips into the field.

Included Accessories:

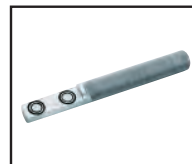

Die Change Tool
KCDCT-H39

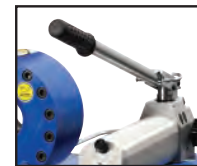

Hand Pump

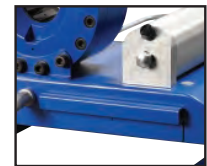

Die Storage
Drawer

Optional Accessories:



Custom Made Dies

HOSES

ONE-PIECE
B SERIES

ONE-PIECE
D SERIES

ONE-PIECE
F & P SERIES

TWO-PIECE FERRULES
(A & PFR SERIES)

TWO-PIECE INSERTS
(A-SERIES)

TWO-PIECE INTERLOCK
FERRULES & INSERTS
(X & Z-SERIES)

QUICK
RELEASE

ASSEMBLY
EQUIPMENT

TECHNICAL
INFORMATION

Because we continually examine ways to improve our products, we reserve the right to alter specifications or discontinue products without prior notice.

HOSES
ONE-PIECE B SERIES
ONE-PIECE D SERIES
ONE-PIECE F & P SERIES
TWO-PIECE FERRULES (A & PFR SERIES)
TWO-PIECE INSERTS (A SERIES)
TWO-PIECE INTERLOCK FERRULES & INSERTS (X & Z SERIES)
QUICK RELEASE
ASSEMBLY EQUIPMENT
TECHNICAL INFORMATION

KC1-H47PI Series



Description: Looking for a reliable crimping machine that won't take up a lot of space? With its small footprint the KC1-H47PI is a perfect fit for crowded shops. Its small size also makes it good for quick trips into the field.

Included Accessories:



Die Change Tool
KCDCT-H39



Air Pump



Die Storage
Drawer

Optional Accessories:



Custom Made Dies

Hose Capacity (in)		Crimping Force (ton)
1 - 2 Wire	1	110
4 SP / 6 SP	NA	
90° Fittings	3/8	
Industrial	NA	

Opening Diameter	
Max. With Dies (mm / in)	49 / 1.93
By Die Size (mm)	Die Size + 20

Crimper Size	
L x W x H (in)	15.0 x 16.9 x 15.8
Weight (lbs)	84

Part Number	Pump Info
KC1-H47PI	Air

Control Mechanism:



Dial micrometer, with electric limit switch indicating when the crimp diameter is reached.

Die Series	Die Range (mm)			
H39	6 - 29			
Die Number	Crimp Range (mm)	Closed Diameter (mm)	Length (mm)	Weight (lbs/ea)
KCDH39-06	6.0 - 8.0	6	55	4.0
KCDH39-08	8.0 - 10.0	8	55	4.0
KCDH39-10	10.0 - 12.0	10	55	4.0
KCDH39-12	12.0 - 14.0	12	55	4.0
KCDH39-14	14.0 - 16.0	14	55	4.0
KCDH39-16	16.0 - 19.0	16	55	4.0
KCDH39-19	19.0 - 22.0	19	55	4.0
KCDH39-22	22.0 - 25.0	22	55	4.0
KCDH39-25	25.0 - 29.0	25	65	4.0
KCDH39-29	29.0 - 34.0	29	65	4.0

* separate air compressor needed to operate

Because we continually examine ways to improve our products, we reserve the right to alter specifications or discontinue products without prior notice.

KD165 Crimper and Components

If your looking for a machine that can do more than just 2 wire hose, the KD165 might be your machine of choice. This machine boasts a 62 ton press, capable of crimping 2 wire and 3000 psi hose up to 1 1/4" and 4000 psi up to 1" ID.

Specifications:

- Dimensions..... L 22" X W 12.5" X H 22.25"
- Weight.....see below
- Pump/Power..... Electric 1 HP (110V)
- Reservoir..... 1 gal.
- Oil Type.....ISO Viscosity Grade 46
- Hose Capacity 1 1/4" 2 wire
..... 1 1/4" 3000 psi
..... 1" 4000 psi

KD165 Crimper Without Dies

Part Number	Description	Weight (lbs)
KD165	Crimper without Dies	154

Rubber Cage Dies for KD165:

Part Number	Description	Weight (lbs/ea)
KD100-12/Purple	12mm Standard Die Purple	5.7
KD100-14/Yellow	14mm Standard Die Yellow	5.5
KD100-16/Orange	16mm Standard Die Orange	5.4
KD100-19/Black	19mm Standard Die Black	5.2
KD100-20/Green	20mm Standard Die Green	5.1
KD100-22/Blue	22mm Standard Die Blue	5.0
KD100-23/Purple	23mm Standard Die Purple	5.0
KD100-27/Brown	27mm Standard Die Brown	4.8
KD100-34/Red	34mm Standard Die Red	4.4
KD100-31/Yellow	31mm Standard Die Yellow	4.6
KD100-39/Red	39mm Standard Die Red	3.8
KD100-41/Silver	41mm Standard Die Silver	3.6

KD165 Series



Uses KD100 Series Rubber Die Cages.



HOSES

ONE-PIECE
B SERIES

ONE-PIECE
D SERIES

ONE-PIECE
F & P SERIES

TWO-PIECE FERRULES
(A & PFR SERIES)

TWO-PIECE INSERTS
(A-SERIES)

TWO-PIECE INTERLOCK
FERRULES & INSERTS
(X & Z-SERIES)

QUICK
RELEASE

ASSEMBLY
EQUIPMENT

TECHNICAL
INFORMATION

Because we continually examine ways to improve our products, we reserve the right to alter specifications or discontinue products without prior notice.

HOSES
ONE-PIECE B SERIES
ONE-PIECE D SERIES
ONE-PIECE F & P SERIES
TWO-PIECE FERRULES (A & PFR SERIES)
TWO-PIECE INSERTS (A SERIES)
TWO-PIECE INTERLOCK FERRULES & INSERTS (X & Z SERIES)
QUICK RELEASE
ASSEMBLY EQUIPMENT
TECHNICAL INFORMATION

KC1-H83 Series



Description: A highly precise unit that packs a punch. Its small footprint makes it an ideal fit for shops where space is at a premium.

Included Accessories:



Die Rack (12 pc.)
DIERACK-H69

Optional Accessories:

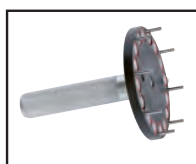

Quick Change Die Tool
KCQCT-H69



Patented Quick Change Die Tool
KCPQCT-H69

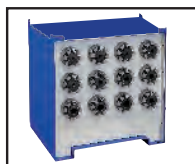

Die Holder Base (12 pc.)
DIEBASE-H69



Electric Foot Pedals
PEDAL-KC1



Custom Made Dies

Hose Capacity (in)		Crimping Force (ton)
1 – 2 Wire	1 1/2	
4 SP / 6 SP	1 1/4 / 1	
90° Fittings	1 1/4	
Industrial	1 1/2	150



Opening Diameter	
Max. Without Dies (mm / in)	111 / 4.37
Max. With Dies (mm / in)	96 / 3.78
By Die Size (mm)	Die Size + 42

Crimper Size	
L x W x H (in)	23.3 x 23.3 x 21.3
Weight (lbs)	264

Part Number	Motor Info
KC1-H83-230/1	4.0 HP (230 V) 1 PH
KC1-H83-230/3	4.0 HP (230 V) 3 PH

Control Mechanism:

- Dial micrometer with locking switch
- Electromechanical controls with power, open/close and emergency off buttons

Die Series		Die Range (mm)		
H69		6 – 54		
Die Number	Crimp Range (mm)	Closed Diameter (mm)	Length (mm)	Weight (lbs/ea)
KCDH69-6	6.0 - 8.0	6	60	4.0
KCDH69-8	8.0 - 10.0	8	60	4.0
KCDH69-10	10.0 - 12.0	10	60	4.0
KCDH69-12	12.0 - 14.0	12	60	4.0
KCDH69-14	14.0 - 16.0	14	60	4.0
KCDH69-16	16.0 - 19.0	16	60	4.0
KCDH69-19	19.0 - 22.0	19	60	4.0
KCDH69-22	22.0 - 25.0	22	60	4.0
KCDH69-25	25.0 - 29.0	25	60	4.0
KCDH69-29	29.0 - 34.0	29	70	4.0
KCDH69-34	34.0 - 38.0	34	70	4.0
KCDH69-38	38.0 - 42.0	38	85	4.0
KCDH69-42	42.0 - 46.0	42	85	4.0
KCDH69-46	46.0 - 50.0	46	85	4.0
KCDH69-50	50.0 - 54.0	50	85	4.0
KCDH69-54	54.0 - 58.0	54	75	4.0

Because we continually examine ways to improve our products, we reserve the right to alter specifications or discontinue products without prior notice.

Hose Capacity (in)		Crimping Force (ton)
1 – 2 Wire	1 1/2	150
4 SP / 6 SP	1 1/4 / 1	
90° Fittings	1 1/4	
Industrial	1 1/2	

Opening Diameter	
Max. Without Dies (mm / in)	111 / 4.37
Max. With Dies (mm / in)	102 / 4.01
By Die Size (mm)	Die Size + 42

Crimper Size	
L x W x H (in)	27.6 x 24.2 x 25.2
Weight (lbs)	386

Part Number	Motor Info
KC3-H88-230/1	5.0 HP (230 V) 1 PH
KC3-H88-230/3	5.0 HP (230 V) 3 PH

Control Mechanism:



ES3

- Full-color, touch-screen display
- Stores up to 200 crimp specifications
- Built-in crimp diameter calculator
- Adjustable reopen diameter
- USB port option for data transfer

Die Series		Die Range (mm)		
H69		10 – 54		
Die Number	Crimp Range (mm)	Closed Diameter (mm)	Length (mm)	Weight (lbs/ea)
KCDH69-6	6.0 - 8.0	6	60	4.0
KCDH69-8	8.0 - 10.0	8	60	4.0
KCDH69-10	10.0 - 12.0	10	60	4.0
KCDH69-12	12.0 - 14.0	12	60	4.0
KCDH69-14	14.0 - 16.0	14	60	4.0
KCDH69-16	16.0 - 19.0	16	60	4.0
KCDH69-19	19.0 - 22.0	19	60	4.0
KCDH69-22	22.0 - 25.0	22	60	4.0
KCDH69-25	25.0 - 29.0	25	60	4.0
KCDH69-29	29.0 - 34.0	29	70	4.0
KCDH69-34	34.0 - 38.0	34	70	4.0
KCDH69-38	38.0 - 42.0	38	85	4.0
KCDH69-42	42.0 - 46.0	42	85	4.0
KCDH69-46	46.0 - 50.0	46	85	4.0
KCDH69-50	50.0 - 54.0	50	85	4.0
KCDH69-54	54.0 - 58.0	54	75	4.0

KC3-H88 Series



Description: The first in its class to offer an automatic back limit switch and ES3 electronic control, greatly increasing crimping efficiency.

Included Accessories:



Back Limit Switch



Crimp Calculator

Optional Accessories:

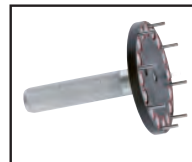

Quick Change Die Tool
KCQCT-H69



Patented Quick Change Die Tool
KCPQCT-H69

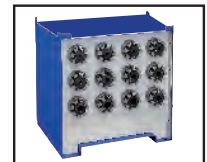

Die Holder Base (12 pc.)
DIEBASE-H69



Die Rack (12 pc.)
DIERACK-H69



Electric Foot Pedal
PEDAL-ES



ES3 Upgrades

Because we continually examine ways to improve our products, we reserve the right to alter specifications or discontinue products without prior notice.

HOSES
ONE-PIECE B SERIES
ONE-PIECE D SERIES
ONE-PIECE F & P SERIES
TWO-PIECE FERRULES (A & PFR SERIES)
TWO-PIECE INSERTS (A SERIES)
TWO-PIECE INTERLOCK FERRULES & INSERTS (X & Z SERIES)
QUICK RELEASE
ASSEMBLY EQUIPMENT
TECHNICAL INFORMATION

KC3-HS54 Series



Description: A model of efficiency, the KC3-HS54 is designed for high-volume production of small to mid-diameter hydraulic hose. Its back limit switch and Siemens ES3 customizable control functions help further minimize crimp cycle times.

Included Accessories:



Back Mirror



Back Limit Switch

Optional Accessories:

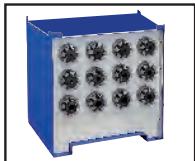

Die Holder Base (12 pc.)
DIEBASE-HS54



Electric Foot Pedal
PEDAL-ES



Patented Quick Change Die Tool
KCPQCT-H83



Quick Change Die Tool
KCQCT-HS54



ES3 Upgrades



Die Rack (12 pc.)
DIERACK-HS54

Hose Capacity (in)		Crimping Force (ton)
1 – 2 Wire	1 1/4	76
4 SP / 6 SP	NA	
90° Fittings	2	
Industrial	NA	

Maximum Opening (mm)	
Without Dies	54
With Dies	Die Size + 28

Crimper Size	
L x W x H (in)	24.2 x 24.2 x 23.3
Weight (lbs)	254

Part Number	Motor Info
KC3-HS54-230/3	4 HP (230V) 3 PH

Control Mechanism:



Siemens ES3 Programmable Controller, with full-color, touch-screen display, provides a wide array of crimp control features to increase crimping efficiency and safety. Stores up to 200 different hose crimp specifications.

Die Series	Die Range (mm)
HS54	8 – 46

Item Number	Crimp Range (mm)	Closed Diameter (mm)	Length (mm)	Weight (lbs/ea)
KCDHS54-10	10.0 - 12.0	10	50	4.0
KCDHS54-12	12.0 - 14.0	12	50	4.0
KCDHS54-14	14.0 - 16.0	14	50	4.0
KCDHS54-16	16.0 - 19.0	16	50	4.0
KCDHS54-19	19.0 - 22.0	19	50	4.0
KCDHS54-22	22.0 - 25.0	22	50	4.0
KCDHS54-25	25.0 - 29.0	25	50	4.0
KCDHS54-29	29.0 - 34.0	29	50	4.0
KCDHS54-34	34.0 - 38.0	34	50	4.0
KCDHS54-38	38.0 - 42.0	38	50	4.0
KCDHS54-42	42.0 - 46.0	42	50	4.0
KCDHS54-46	46.0 - 50.0	46	50	4.0

Because we continually examine ways to improve our products, we reserve the right to alter specifications or discontinue products without prior notice.

Hose Capacity (in)	Crimping Force (ton)
1 – 2 Wire	330
4 SP / 6 SP	
90° Fittings	
Industrial	

Opening Diameter	
Max. Without Dies (mm / in)	162 / 6.38
Max. With Dies (mm / in)	139 / 5.47
By Die Size (mm)	Die Size + 43

Crimper Size	
L x W x H (in)	30.7 x 24.8 x 28.1
Weight (lbs)	704

Part Number	Motor Info
KC1-H135-230/1	5.5 HP (230 V) 1 PH
KC1-H135-230/3	7.5 HP (230 V) 3 PH

Die Series	Die Range (mm)
H119	6 – 96

Refer to page 284 for available dies.

Control Mechanism:

- Dial micrometer with locking switch
- Electromechanical controls with power, open/close and emergency off buttons



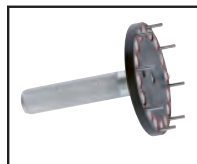

Optional Accessories:

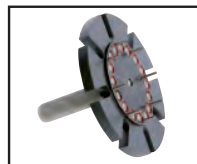

Quick Change Die Tool
KCQCT-H119

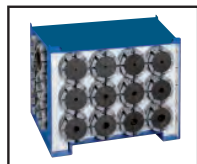

Patented Quick Change Die Tool
KCPQCT-H135/144



Die Holder Base (18 pc.)
DIEBASE-H119



Die Rack (8 pc.)
DIERACK-H119



Electric Foot Pedals
PEDAL-KC1



Cleaning and Lubrication Kit
CALKIT-H135



Custom Made Dies



Marking Dies

KC1-H135 Series



Description: A powerful, no frills crimper that gets the job done. Handles all styles of hydraulic hose up to 2", as well as industrial hose up to 3".

HOSES

ONE-PIECE
B SERIES

ONE-PIECE
D SERIES

ONE-PIECE
F & P SERIES

TWO-PIECE FERRULES
(A & PFR SERIES)

TWO-PIECE INSERTS
(A-SERIES)

TWO-PIECE INTERLOCK
FERRULES & INSERTS
(X & Z-SERIES)

QUICK
RELEASE

ASSEMBLY
EQUIPMENT

TECHNICAL
INFORMATION

Because we continually examine ways to improve our products, we reserve the right to alter specifications or discontinue products without prior notice.

Standard Volume Crimper



HOSES
ONE-PIECE B SERIES
ONE-PIECE D SERIES
ONE-PIECE F & P SERIES
TWO-PIECE FERRULES (A & PFR SERIES)
TWO-PIECE INSERTS (A SERIES)
TWO-PIECE INTERLOCK FERRULES & INSERTS (X & Z SERIES)
QUICK RELEASE
ASSEMBLY EQUIPMENT
TECHNICAL INFORMATION

KC3-H170 Series



Widest Opening

Description: The widest opening of all the Standard Volume Crimpers, makes it ideal for industrial hose up to 4". It makes an excellent hydraulic hose crimper as well, handling up to 2" wire braid and 4 SP hose, along with our 6 SP hoses up to 5000 PSI using F Series, 1-piece fittings.

Included Accessories:



Back Limit Switch



Crimp Calculator

Optional Accessories:

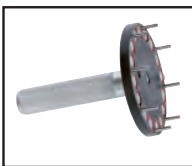

Quick Change Die Tool
KCQCT-H119

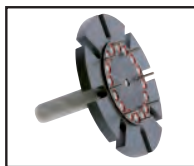

Patented Quick Change Die Tool
KCPQCT-H135/144

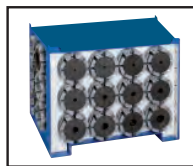

Die Holder Base (18 pc.)
DIEBASE-H119



Die Rack (8 pc.)
DIERACK-H119



Electric Foot Pedal
PEDAL-ES



ES3 Upgrades



Cleaning and Lubrication Kit
CALKIT-H144/170



Custom Made Dies



Marking Dies

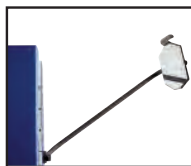

Back Mirror
MIRROR-H170

Hose Capacity (in)		Crimping Force (ton)
1 – 2 Wire	2	308
4 SP / 6 SP	2 / 2*	
90° Fittings	2	
Industrial	4	

*2" limited to 5000 PSI hose using 1-pc fittings

Opening Diameter	
Max. Without Dies (mm / in)	219 / 8.62
Max. With Dies (mm / in)	192 / 7.56
By Die Size (mm)	Die Size + 61

Crimper Size	
L x W x H (in)	32.3 x 25.9 x 33.0
Weight (lbs)	1,102

Part Number	Motor Info
KC3-H170-230/3	7 HP (230 V) 3 PH

Die Series	Die Range (mm)
H119 & H144	6 – 131*

* Custom Dies available to 138 mm

Refer to page 284 for available dies.

Control Mechanism:	
 ES3	<ul style="list-style-type: none"> • Full-color, touch-screen display • Stores up to 200 crimp specifications • Built-in crimp diameter calculator • Adjustable reopen diameter • USB port option for data transfer

Because we continually examine ways to improve our products, we reserve the right to alter specifications or discontinue products without prior notice.

Hose Capacity (in)		Crimping Force (ton)
1 – 2 Wire	2	345
4 SP / 6 SP	2	
90° Fittings	2	
Industrial	3	

Opening Diameter	
Max. Without Dies (mm / in)	162 / 6.38
Max. With Dies (mm / in)	108 / 4.25
By Die Size (mm)	Die Size + 43

Crimper Size	
L x W x H (in)	32.3 x 29.5 x 32.3
Weight (lbs)	1,047

Part Number	Motor Info
KC3-H135-230/3	7.5 HP (230 V) 3 PH

Die Series	Die Range (mm)
H119	8 – 96

Refer to page 284 for available dies.

Control Mechanism:	
	<ul style="list-style-type: none"> • Full-color, touch-screen display • Stores up to 200 crimp specifications • Built-in crimp diameter calculator • Adjustable reopen diameter • USB port option for data transfer
ES3	

Optional Accessories:

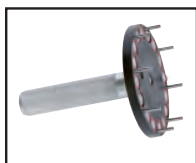

Quick Change Die Tool
KCQCT-H119



Patented Quick Change Die Tool
KCPQCT-H135/144

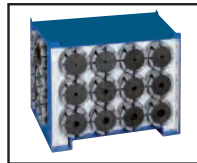

Die Holder Base (18 pc.)
DIEBASE-H119



Die Rack (8 pc.)
DIERACK-H119



Electric Foot Pedal
PEDAL-ES



ES3 Upgrades



Cleaning and Lubrication Kit
CALKIT-H135



Custom Made Dies

KC3-H135 Series



Description: The production oriented KC3-H135 is a powerful shop crimper that handles all types and sizes of hydraulic hose up to 2" and industrial hose up to 3". Its back limit switch and ES3 computerized controller reduce crimp cycle times.

Included Accessories:



Back Limit Switch



Crimp Calculator

HOSES

ONE-PIECE B SERIES

ONE-PIECE D SERIES

ONE-PIECE F & P SERIES

TWO-PIECE FERRULES (A & PFR SERIES)

TWO-PIECE INSERTS (A-SERIES)

TWO-PIECE INTERLOCK FERRULES & INSERTS (X & Z-SERIES)

QUICK RELEASE

ASSEMBLY EQUIPMENT

TECHNICAL INFORMATION

Because we continually examine ways to improve our products, we reserve the right to alter specifications or discontinue products without prior notice.

Standard Volume Crimpers



HOSES
ONE-PIECE B SERIES
ONE-PIECE D SERIES
ONE-PIECE F & P SERIES
TWO-PIECE FERRULES (A & PFR SERIES)
TWO-PIECE INSERTS (A SERIES)
TWO-PIECE INTERLOCK FERRULES & INSERTS (X & Z SERIES)
QUICK RELEASE
ASSEMBLY EQUIPMENT
TECHNICAL INFORMATION

Available Dies for KC1-H135, KC3-H135, KC3-H144 and KC3-H170 Series Crimpers

Die Number	Crimp Range (mm)	Closed Diameter (mm)	Length (mm)	Weight (lbs/ea)
KCDH119-6	6.0 - 8.0	6	60	11.7
KCDH119-8	8.0 - 10.0	8	60	11.7
KCDH119-10	10.0 - 12.0	10	60	11.7
KCDH119-12	12.0 - 14.0	12	60	11.7
KCDH119-14	14.0 - 16.0	14	60	11.7
KCDH119-16	16.0 - 19.0	16	60	11.7
KCDH119-19	19.0 - 22.0	19	60	11.7
KCDH119-22	22.0 - 25.0	22	60	12.2
KCDH119-25	25.0 - 29.0	25	60	12.0
KCDH119-29	29.0 - 34.0	29	70	12.0
KCDH119-34	34.0 - 38.0	34	70	12.0
KCDH119-38	38.0 - 42.0	38	85	12.0
KCDH119-42	42.0 - 46.0	42	85	15.5
KCDH119-46	46.0 - 50.0	46	95	16.5
KCDH119-50	50.0 - 54.0	50	95	15.5
KCDH119-54x110	54.0 - 58.0	54	110	15.5
KCDH119-58	58.0 - 63.0	58	95	14.5
KCDH119-60x110	60.0 - 63.0	58	110	14.5
KCDH119-63x120	63.0 - 69.0	63	120	14.5
KCDH119-69	69.0 - 73.0	69	100	13.5
KCDH119-73x120	73.0 - 77.0	73	120	12.5
KCDH119-77	77.0 - 86.0	77	120	12.5
KCDH119-86	86.0 - 90.0	86	120	12.5
KCDH119-90	90.0 - 96.0	90	150	12.5
KCDH119-96	96.0 - 103.0	96	120	12.5



Additional Dies for KC3-H144 and KC3-H170 Series Crimpers only

Die Number	Crimp Range (mm)	Closed Diameter (mm)	Length (mm)	Weight (lbs/ea)
KCDH144-103	103.0 - 106.0	103	130	12.5
KCDH144-106	106.0 - 111.0	106	130	12.5
KCDH144-111	111.0 - 116.0	111	130	12.5
KCDH144-116	116.0 - 121.0	116	130	12.5
KCDH144-121	121.0 - 126.0	121	130	12.5
KCDH144-126	126.0 - 131.0	126	130	12.5
KCDH144-131	131.0 - 144.0*	131	130	12.5

*Crimp range up to 170 mm for KC3-H170 crimper, with custom dies available up to 138 mm.

Because we continually examine ways to improve our products, we reserve the right to alter specifications or discontinue products without prior notice.

ES3 Programmable Electronic Controller

Included on all KC3 Series Crimpers

ES3 Programmable Logic Controller, with 5.7" wide, full-color, touch-screen display. Delivers the following crimp control options, in an easy to navigate format, improving crimp quality, safety, and reduced crimp cycle times.

Crimp Specification Memory - Stores up to 200 separate hose crimp specifications for immediate recall.

Crimp Calculator – Automatically calculates crimp diameter based on hose ID, OD, shank OD and ferrule thickness.

Multiple Crimp Cycles - Choose between manual, automatic and semi-automatic crimping modes, with the ability to toggle between modes during crimping.

Adjustable Reopen Diameter – Allows operator to set smaller reopen diameters, eliminating the need for the dies to fully reset in between crimps, reducing crimp cycle time when doing multiple crimps of the same type.



All ES3 equipped with built-in crimp diameter calculator.

ES3 UPGRADE OPTIONS

USB Port Connection - Allows for easy uploading or downloading of crimp specifications in CSV format.

Multi-step Crimp Option - Executes up to 5 different crimp diameters in succession. Reduces cycle time in instances when crimping multiple hoses when more than one crimp diameter is required.

Quality Check Function - Compares actual recorded crimping pressure with pre-determined acceptable pressure range in order to help ensure crimp was performed properly and help catch anomalies.

Pressure Controlled Crimping - Allows for crimping according to force instead of diameter.

USB Port

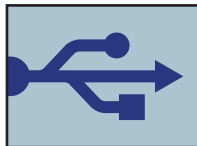

Part Number	Works with Crimpers
ES3-USB	All KC3 Series Models

Quality Check

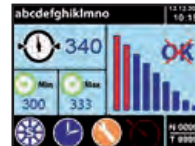

Part Number	Works with Crimpers
ES3-QUAL	All KC3 Series Models

Multistep Crimping



Part Number	Works with Crimpers
ES3-MULTI	All KC3 Series Models

Pressure Controlled Crimping



Part Number	Works with Crimpers
ES3-PRESS	All KC3 Series Models

Because we continually examine ways to improve our products, we reserve the right to alter specifications or discontinue products without prior notice.

- HOSES
- ONE-PIECE B SERIES
- ONE-PIECE D SERIES
- ONE-PIECE F & P SERIES
- TWO-PIECE FERRULES (A & PFR SERIES)
- TWO-PIECE INSERTS (A SERIES)
- TWO-PIECE INTERLOCK FERRULES & INSERTS (X & Z SERIES)
- QUICK RELEASE
- ASSEMBLY EQUIPMENT
- TECHNICAL INFORMATION

KuriSaws™

The **KuriSaws™** are available to meet your hydraulic hose cutting needs. Several options are available to improve your cuts, blade life and hose cutting accuracy.

KCS-TF1/E-110/1

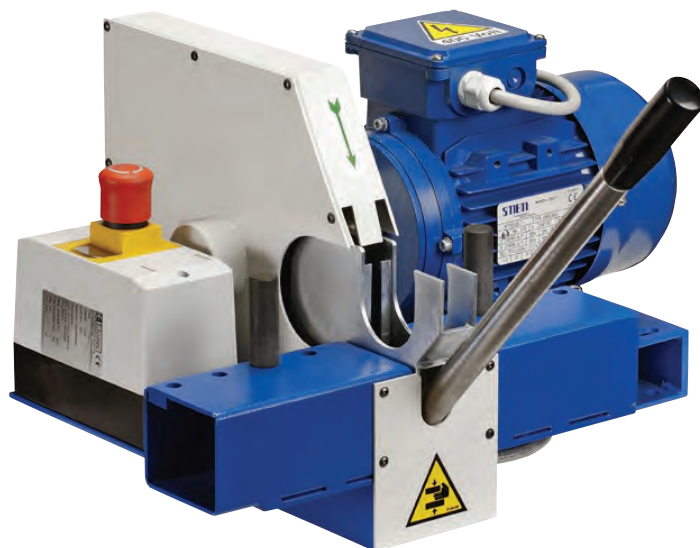

The new KCS-TF1/E-110/1 is an inexpensive and compact cutting machine, ideal for cutting flexible hydraulic hoses up to 1 1/4" four spirals and up to 1" six spirals. 12V power pack available upon request. Also available in 230V 3 PH.

Weight: 66 (lbs)

MAIN FEATURES:

- Suction connection
- Manually operated
- Recessed blade for the operator's safety

Because we continually examine ways to improve our products, we reserve the right to alter specifications or discontinue products without prior notice.

KuriSaws™ Plus

KCS-TF2/E-230/1



The KCS-TF2/E-230/1 is ideal for cutting flexible hydraulic hoses up to 2" four spirals and 1 1/2" six spirals. Also available in 230V 3 PH.

Weight: 97 (lbs)

MAIN FEATURES:

- Ø 250 mm serrated blade
- Manually operated
- Recessed blade and guards for the operator's safety

KCS-TF3/E-230/1



The KCS-TF3/E-230/1 is an inexpensive and compact cutting machine, ideal for cutting flexible hydraulic hoses up to 2" six spirals. Also available in 230V 3 PH.

Weight: 97 (lbs)

MAIN FEATURES:

- Ø 350 mm serrated blade
- Manually operated
- Recessed blade and guards for the operator's safety

HOSES

ONE-PIECE
B SERIES

ONE-PIECE
D SERIES

ONE-PIECE
F & P SERIES

TWO-PIECE FERRULES
(A & PFR SERIES)

TWO-PIECE INSERTS
(A SERIES)

TWO-PIECE INTERLOCK
FERRULES & INSERTS
(X & Z SERIES)

QUICK
RELEASE

ASSEMBLY
EQUIPMENT

TECHNICAL
INFORMATION

Because we continually examine ways to improve our products, we reserve the right to alter specifications or discontinue products without prior notice.

HOSES
ONE-PIECE B SERIES
ONE-PIECE D SERIES
ONE-PIECE F & P SERIES
TWO-PIECE FERRULES (A & PFR SERIES)
TWO-PIECE INSERTS (A SERIES)
TWO-PIECE INTERLOCK FERRULES & INSERTS (X & Z SERIES)
QUICK RELEASE
ASSEMBLY EQUIPMENT
TECHNICAL INFORMATION

The KuriCrimp™ Electric Skive Tool and the Manual Skive Tool are the only skive tool you will need to skive hydraulic hoses from 1/4" ID thru 2" ID. The unique design on both of these skive tools has an adjustable cutting arm for depth of skive from 1/4" thru 2" external skiving and only inexpensive simple mandrel changes are required saving a lot of money on expensive skive heads that are only designed for an individual hose size. Internal skiving is achieved by changing out the external skive mandrels for an internal skive mandrel with built in and replaceable cutting head. Overall cost of owning skiving tooling is greatly reduced with using these professional grade skive tools.

KSKIVE2



This device allows internal and external skiving of hydraulic hoses up to a 2" diameter. KSKIVE2 is provided with a fixed tool-holder spindle with only one cutter provided on which is a millimetric ruler which allows setting the skiving distance. Thus, replacement of the pin and adjustment of position of the tool according to the diameter of the hose to be skived is required. Also available in the 12V version, this is the perfect device for outdoor assistance.

Weight: 110 (lbs)

MAIN FEATURES:

- Pedal-equipped electric control
- Tool-holder
- Drawer for shavings

KSKIVE1



This device allows internal and external skiving of hydraulic hoses up to a 2" diameter.

KSKIVE1 is provided with a fixed tool-holder spindle with only one cutter provided on which is a millimetric ruler which allows setting the skiving distance. Thus, replacement of the pin and adjustment of position of the tool according to the diameter of the hose to be skived is required. Light and easy to use, it is the perfect equipment for outdoor service.

Weight: 15 (lbs)

Because we continually examine ways to improve our products, we reserve the right to alter specifications or discontinue products without prior notice.

ALFAGOMMA Steel Protective Coil Springs and Flat Coil Sleeves prolong the life of hose lines that are exposed to rugged operating conditions.

They distribute the bending radii to avoid kinking in hose lines and protect the hose from excessive

wear caused by sharp edges and abrasion and help protect the hose from deep cuts.

The guards are constructed of steel and are plated to resist rust.

Steel Protective Coil Springs – SRS

Application – Protects hose cover and reinforcement from abrasion and accidental damage.

Length – 13'-1 1/2" (4 m)



Part Number	DIN SAE ID		1SN R1AT FXP2 Alfatech 3000		2SN R2AT		ABT3K ABT4k		ABT5K ABT6K		Weight (lbs/coil)
	(in)	(mm)	DN	Size	DN	Size	DN	Size	DN	Size	
	R1S0033-0154	0.61	15.5	6	-04						
R1S0033-0174	0.67	17.0	8	-05	6	-04					2.20
R1S0033-0194	0.75	19.0	10	-06	8	-05				-04	2.37
R1S0033-0234	0.91	23.0	12	-08	10	-06	10	-06		-06	3.12
R1S0033-0264	1.02	26.0	16	-10	12	-08	12	-08		-08	5.27
R1S0033-0294	1.14	29.0	20	-12					-10	-10	5.58
R1S0033-0344	1.34	34.0			16 20	-10 -12	20	-12	20	-12	6.35
R1S0055-0414	1.61	41.0	25	-16	25	-16	25	-16	25	-16	8.00
R1S0055-0484	1.89	48.0							-20		8.61
R1S0055-0544	2.13	54.0	32	-20	32	-20			-24		9.88
R1S0055-0604	2.36	60.0			40	-24			40	-24	30.44

Steel Protective Flat Coil Sleeve – SSF

Application – For use where hose lines are subjected to excessive abrasion, kinking, or accidental damage.

Length – 13'-1 1/2" (4 m)



Part Number	DIN SAE ID		1SN R1AT FXP2 Alfatech 3000		2SN R2AT		ABT3K ABT4k		ABT5K ABT6K		Weight (lbs/coil)
	(in)	(mm)	DN	Size	DN	Size	DN	Size	DN	Size	
	R1S1017-0134	0.51	13.0								
R1S1017-0154	0.61	15.5	6	-04							1.38
R1S1017-0174	0.67	17.0	8	-05	6	-04					1.51
R1S1017-0194	0.75	19.0	10	-06	8	-05					2.47
R1S1017-0224	0.87	22.0	12	-08	10	-06	10	-06			2.87
R1S1017-0264	1.02	26.0	16	-10	12	-08	12	-08			3.59
R1S1017-0284	1.10	28.0									3.83
R1S1017-0304	1.18	30.0	20	-12	16	-10	25	-16			4.13
R1S1017-0344	1.34	34.0			20	-12	16 20	-10 -12	20	-12	4.42
R1S1017-0414	1.61	41.0	25	-16	25	-16	25	-16	25	-16	8.19
R1S1017-0484	1.89	48.0									9.22
R1S1017-0544	2.13	54.0	32	-20	32	-20			32	-20	8.41
R1S1017-0604	2.36	60.0			40	-24			40	-24	11.70

Because we continually examine ways to improve our products, we reserve the right to alter specifications or discontinue products without prior notice.

HOSES
 ONE-PIECE B SERIES
 ONE-PIECE D SERIES
 ONE-PIECE F & P SERIES
 TWO-PIECE FERRULES (A & PFR SERIES)
 TWO-PIECE INSERTS (A SERIES)
 TWO-PIECE INTERLOCK FERRULES & INSERTS (X & Z SERIES)
 QUICK RELEASE
 ASSEMBLY EQUIPMENT
 TECHNICAL INFORMATION

Plastic Protective Coil Sleeve – PCG

Application – The high density polyethylene plastic coil sleeve is air, water, oil, gasoline and hydraulic fluid-resistant at temperatures between 0°F (-18°C) to +84°F (+29°C).



This coil can also be used for bundling groups of hoses. Other colors available on request.

Part Number	ID (in)	Wall Thickness (in)	For Use on These Hoses	Roll Length (ft)	Weight (lbs/coil)
PCG-16-H	0.50	0.069	TR1MT, TF2MT/ST, TR2MT, ABT4K, ABT5K, ABT6K	100	6.00
PCG-20-H	0.66	0.075	TR1MT, TF2MT/ST, TR2MT, ABT4K, ABT6K	100	9.00
PCG-25-H	0.75	0.122	TR1MT, TF2MT/ST, TR2MT, ABT4K, ABT6K	100	14.00
PCG-32-H	1.00	0.118	TR1MT, TF2MT/ST, TR2MT, ABT4K, ABT6K	100	21.00
PCG-39-H	1.25	0.132	TR1MT, TF2MT/ST, TR2MT, ABT4K, ABT5K, ABT6K	100	20.00
PCG-50-H	1.60	0.150	TR1MT, TF2MT/ST, TR2MT, ABT3K, ABT4K, ABT5K, ABT6K	100	17.00
PCG-59-H	2.00	0.160	TR1MT, TF2MT/ST, TR2MT, ABT3K, ABT4K, ABT5K, ABT6K	100	41.00
PCG-75-H	2.50	0.209	TR1MT, TF2MT/ST, TR2MT, ABT3K, ABT4K, ABT5K, ABT6K	75	36.00

Nylon Sleeve Guard

Extend the life of your hose assemblies with Kuriyama's Nylon Sleeve Guard. This unique tubular black woven product provides ideal physical protection against abrasion and other external conditions found in many hydraulic hose applications. Additionally, this sleeving serves as a means of bundling several hydraulic hoses together for further protection and clean routing.

The nylon tubular sleeving withstands temperatures of +250°F (+121°C) and has MSHA acceptance, while maintaining its flexibility in extreme cold applications.

Standard packaging is 100 foot rolls. Other lengths are available upon request.



Part Number	Nominal Flat Size (in)	Range of Hose OD's for this size	Round ID (in)	Coil Size (ft)	Weight (lbs/coil)
NS-04x100	1.2500	0.48 - 0.70	0.796	100	2.99
NS-06x100	1.5000	0.61 - 0.84	0.955	100	3.02
NS-08x100	1.8750	0.77 - 0.97	1.194	100	4.37
NS-10x100	1.9375	0.93 - 1.11	1.234	100	4.12
NS-12x100	2.1250	1.09 - 1.27	1.353	100	4.11
NS-16x100	2.5625	1.40 - 1.56	1.632	100	2.72
NS-20x100	3.3125	1.71 - 1.96	2.109	100	3.58
NS-24x100	3.8125	1.99 - 2.26	2.428	100	4.17
NS-32x100	4.5625	2.52 - 2.79	2.906	100	4.92

"Nominal Flat Size" refers to the width of the sleeving when flat, radius to radius.

It is recommended that the ends of the sleeves be heated after cutting to resist fraying. For secure fastening, sleeves are often band clamped or tied with nylon ties.

Because we continually examine ways to improve our products, we reserve the right to alter specifications or discontinue products without prior notice.

Flexible “Floppy Guard” Interlocked Metal Hose – HT1100

Highly-flexible interlocked metal armor hose provides maximum protection for hydraulic hoses in the most severe applications.

Construction – A single metal strip is loosely interlock-wound to create an extremely flexible interlocked metal hose.

Available in galvanized steel and stainless steel.

Applications – Armor shielding for hoses where maximum flexibility and protection from abrasion and damage are important.



Maximum Service Temperature:

Galvanized Steel: Up to 750°F

Stainless Steel: Up to 1800°F

SPECIFICATIONS (Lengths and Weights are based on extended hose and are approximate)

HTG1100 – Galvanized – .010" – .012" strip thickness

Part Number	ID (in)	Std. Length Coils (ft)	Weight (lbs/coil)
HTG1100-018X25	3/16	25	2.00
HTG1100-025X25	1/4	25	2.50
HTG1100-031X25	5/16	25	3.00
HTG1100-037X25	3/8	25	3.50
HTG1100-050X25	1/2	25	4.00
HTG1100-062X25	5/8	25	4.50
HTG1100-075X25	3/4	25	5.00
HTG1100-087X25	7/8	25	5.75
HTG1100-100X25	1	25	7.00
HTG1100-112X25	1 1/8	25	8.00
HTG1100-125X25	1 1/4	25	9.00
HTG1100-137X25	1 3/8	25	10.50
HTG1100-150X25	1 1/2	25	12.00
HTG1100-162X25	1 5/8	25	13.00
HTG1100-175X25	1 3/4	25	14.50
HTG1100-187X25	1 7/8	25	15.50
HTG1100-200X25	2	25	16.50
HTG1100-225X25	2 1/4	25	19.00

HTS1100 – Stainless Steel – .010" – .012" strip thickness

Part Number	ID (in)	Std. Length Coils (ft)	Weight (lbs/coil)
HTS1100-018X25	3/16	25	2.00
HTS1100-025X25	1/4	25	2.50
HTS1100-031X25	5/16	25	3.00
HTS1100-037X25	3/8	25	3.50
HTS1100-050X25	1/2	25	4.00
HTS1100-062X25	5/8	25	4.50
HTS1100-075X25	3/4	25	5.00
HTS1100-087X25	7/8	25	5.75
HTS1100-100X25	1	25	7.00
HTS1100-112X25	1 1/8	25	8.00
HTS1100-125X25	1 1/4	25	9.00
HTS1100-137X25	1 3/8	25	10.50
HTS1100-150X25	1 1/2	25	12.00
HTS1100-162X25	1 5/8	25	13.00
HTS1100-175X25	1 3/4	25	14.50
HTS1100-187X25	1 7/8	25	15.50
HTS1100-200X25	2	25	16.50
HTS1100-225X25	2 1/4	25	19.00

Because we continually examine ways to improve our products, we reserve the right to alter specifications or discontinue products without prior notice.

Technical Information Index



HOSES
ONE-PIECE B SERIES
ONE-PIECE D SERIES
ONE-PIECE F & P SERIES
TWO-PIECE FERRULES (A & PFR SERIES)
TWO-PIECE INSERTS (A SERIES)
TWO-PIECE INTERLOCK FERRULES & INSERTS (X & Z SERIES)
QUICK RELEASE
ASSEMBLY EQUIPMENT
TECHNICAL INFORMATION

Assembly Length	300 - 301	Hex Dimensions	321
Cautionary Statement & Limited Warranty.....	323	Hydraulic Hose Sizing Nomogram.....	297
Conversion Charts.....	319 - 320	Installation & Assembly.....	302-303
Fitting Identification	304	Pressure & Distance Conversions	319
Fitting Identification - American.....	306 - 310	Pressure Drop International Chart	299
Fitting Identification - British	311	Pressure Drop U.S. Chart	298
Fitting Identification - French.....	312	Safety Guide	294 - 296
Fitting Identification - German.....	313 - 314	Temperature Conversions	320
Fitting Identification - Japanese.....	315 - 316	Thread Type.....	305
		Torque Data	317 - 318

Because we continually examine ways to improve our products, we reserve the right to alter specifications or discontinue products without prior notice.



HOSES
ONE-PIECE B SERIES
ONE-PIECE D SERIES
ONE-PIECE F & P SERIES
TWO-PIECE FERRULES (A & PFR SERIES)
TWO-PIECE INSERTS (A SERIES)
TWO-PIECE INTERLOCK FERRULES & INSERTS (X & Z SERIES)
QUICK RELEASE
ASSEMBLY EQUIPMENT
TECHNICAL INFORMATION

Safety Guide and Basic Factors for Selecting, Installing & Maintaining Hose and Hose Assemblies

Hydraulic hose (and hose assemblies) has a limited life dependent on service conditions to which it is applied. Subjecting hose (and hose assemblies) to conditions more severe than the recommended limits significantly reduce service life. Exposure to combinations of recommended limits (i.e., continuous use at maximum rated working pressure, maximum recommended operating temperature and minimum bend radius) will also reduce service life.

WARNING: FAILURE TO FOLLOW PROPER SELECTION, INSTALLATION AND MAINTENANCE PROCEDURES MAY RESULT IN PREMATURE FAILURES, BODILY INJURY, AND DAMAGE TO PROPERTY.

1. SELECTION – The following is a list of factors which must be considered before the selection of a hose can be made:

1.1 Line size:

In order to achieve maximum efficiency in a hydraulic system, it is necessary to keep pressure losses (resistance to the volumetric flow) to a minimum when a fluid is conveyed by the different types of flow lines.

When a fluid flows through a flow line, heat is generated by friction. Thus part of the energy is lost as heat energy, which results in a pressure loss.

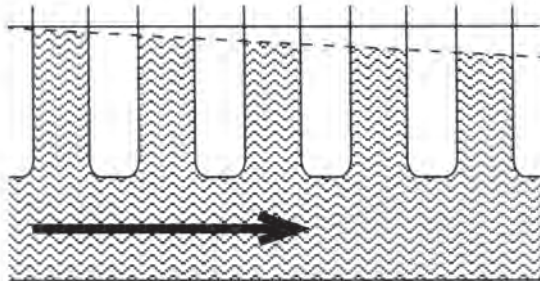

These pressure losses depend upon:

- Flow velocity (for a given volumetric flow, the fluid flow velocity increases with a decrease in the cross sectional area of a flow line and vice versa) · length of the flow line
- The viscosity of the fluid flowing
- The density of the fluid flowing
- The type of flow (laminar or turbulent)

Types of flow – The type of flow changes from laminar to turbulent at a certain flow velocity. This velocity is given by the Reynold's Number Re.

For cylindrical flow lines the following formula applies:

$$Re = \frac{vxd}{\nu}$$

where v = velocity (m/s)
d = flow line internal dia. (m)
 ν = kinematic viscosity (m²/s)

As soon as the value for Re exceeds 2300, the laminar flow changes to turbulent flow.

Laminar flow – In laminar flow, the individual fluid particles move up to certain speeds in uniform layers alongside each other. They scarcely disturb or influence each other.

Turbulent flow – If the value for Re exceeds 2300, flow becomes whirling and turbulent. The individual particles no longer move in one direction in an orderly fashion, but influence and hinder each other.

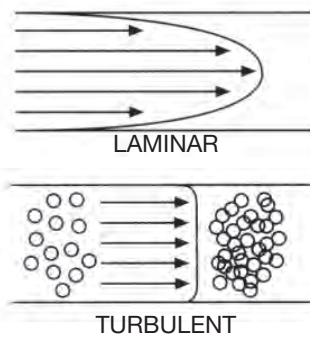

Certain fluid flow velocities have proved to be most suitable for hydraulic flow lines.

Recommended flow velocities:

Suction lines: 0.5	1.2 m/s	1.6	4 feet/s
Return lines: 2	3 m/s	6.5	10 feet/s
Pressure lines: 4	7.5 m/s	13	25 feet/s

It is therefore important to calculate correctly the required flow line sizes. Undersized pressure lines result in high fluid velocity causing an excessive pressure drop, and heat build up, which impair overall system performance. Undersized suction lines can cause cavitation at the hydraulic pump inlet, affecting performance, shortening pump life, and creating excessive noise levels.

The flow capacity nomogram on page 14 is an aid to determine the correct hose internal diameter size, desired flow rate and recommended velocity. By the use of any two known factors, the third can be determined.

1.2 Pressure:

After determining the system pressure for a hydraulic system, hose selection must be made so that the recommended maximum operating pressure specified by a given hose, is equal or greater than the system pressure. Dynamic pressure is common for all hydraulic systems.

Pressure surges which exceed the maximum working pressure (pressure relief valve setting) affect the service life of system components, including a hose assembly and therefore need to be taken into consideration. Hoses used for suction lines must be selected to ensure the hose will withstand the negative pressure of the system.

Because we continually examine ways to improve our products, we reserve the right to alter specifications or discontinue products without prior notice.

1.3 Temperature:

Care must be taken to ensure that the operating temperature of the fluid being conveyed and ambient temperatures, do not exceed the limitations of the hose. Special care must be taken when routing near hot manifolds or molten metal.

1.4 Fluid Compatibility:

Hose selection must assure compatibility of the hose tube, cover, reinforcement, and fittings with the fluid used. Additional caution must be observed in hose selection for gaseous applications. Some fire resistant fluids require the same hose as petroleum oil. Some use a special hose, while a few fluids will not work with any hose at all.

1.5 Permeation:

Permeation (that is, seepage through the hose) will occur from inside the hose to outside when hose is used with gases, liquid and gas fuels, and refrigerants (including but not limited to such materials such as helium, fuel oil, natural gas, or freon). This permeation may result in high concentrations of vapors which are potentially flammable, explosive, or toxic, and in loss of fluid.

Even though the fluid compatibility is acceptable, you must take into account the fact that permeation will occur and could be hazardous. Permeation of moisture from outside the hose to inside the hose will also occur. If this moisture permeation would have detrimental effects (particularly but not limited to refrigeration and air conditioning systems), incorporation of sufficient drying capacity in the system or other appropriate system safeguards should be selected and used.

1.6 Routing:

Attention must be given to optimum routing to minimize inherent problems. Restrain, protect or guide hose with the use of clamps if necessary to minimize risk or damage due to excessive flexing, whipping or contact with other moving parts or corrosives. Determine hose lengths and configurations that will result in proper routing and protection from abrasion, snagging or kinking and provide leak resistant connections.

1.7 Environment:

Care must be taken to ensure that the hose and fittings are either compatible with or protected from the environment to which they are exposed. Environmental conditions including but not limited to ultraviolet light, heat, ozone, moisture, water, salt water, chemicals, and air pollutants can cause degradation and premature failure and, therefore, must be considered.

1.8 Mechanical Loads:

External forces can significantly reduce hose life. Mechanical loads which must be considered include excessive flexing, twist, kinking, tensile or side loads, bend radius, and vibration. Use of swivel type fittings or adaptors may be required to ensure no twist is put into the hose. Unusual applications may require special testing prior to hose selection.

1.9 Abrasion:

While a hose is designed with a reasonable level of abrasion resistance, care must be taken to protect the hose from excessive abrasion which can result in erosion, snagging, and

cutting of the hose cover. Exposure of the reinforcement will significantly accelerate hose failure.

1.10 Proper End Fitting:

Care must be taken to ensure proper compatibility exists between the hose and coupling selected based on the manufacturer's recommendations substantiated by testing to industry standards such as

SAE J517
DIN 20024, JIS B 8360.

1.11 Length:

When establishing proper hose length, motion absorption, hose length changes due to pressure, as well as hose and machine tolerances must be considered.

1.12 Specifications and Standards:

When selecting hose and fittings, government, industry, and manufacturer's specifications and recommendations must be reviewed as applicable.

1.13 Hose Cleanliness:

Hose components may vary in cleanliness levels. Care must be taken to ensure that the assemblies selected have an adequate level of cleanliness for the application.

1.14 Welding and Brazing:

Heating of plated parts, including hose fittings and adaptors, above 232°C (450°F) such as during welding, brazing, or soldering may emit deadly gases.

1.15 Electrical Conductivity:

Certain applications require that a hose be non-conductive to prevent electrical current flow. Other applications require the hose to be sufficiently conductive to drain off static electricity.

Extreme care must be exercised when selecting hose and fittings for these or any other applications in which electrical conductivity or non-conductivity is a factor.

For applications that require hose to be electrically non-conductive, including but not limited to applications near high voltage electric lines, only special non-conductive hose can be used.

The manufacturer of the equipment in which the non-conductive hose is to be used must be consulted to be certain that the hose and fittings that are selected are proper for the application.

Do not use any ALFAGOMMA hose or fitting for any application requiring non-conductive hose, including but not limited to applications near high voltage electric lines, unless the application is expressly approved in the ALFAGOMMA technical publication for the product, the hose is both orange in color and marked "non-conductive," and the manufacturer of the equipment on which the hose is to be used specifically approves the particular ALFAGOMMA hose and fitting for such use.

ALFAGOMMA does not supply any hose or fittings for conveying paint in airless paint spraying or similar applications and therefore should not be used. A special hose and fitting assembly is required for this application, to avoid static electricity buildup which could cause a spark that may result in an explosion and/or fire.

Because we continually examine ways to improve our products, we reserve the right to alter specifications or discontinue products without prior notice.

HOSES
ONE-PIECE B SERIES
ONE-PIECE D SERIES
ONE-PIECE F & P SERIES
TWO-PIECE FERRULES (A & PFR SERIES)
TWO-PIECE INSERTS (A-SERIES)
TWO-PIECE INTERLOCK FERRULES & INSERTS (X & Z-SERIES)
QUICK RELEASE
ASSEMBLY EQUIPMENT
TECHNICAL INFORMATION

HOSES

ONE-PIECE
B SERIES

ONE-PIECE
D SERIES

ONE-PIECE
F & P SERIES

TWO-PIECE FERRULES
(A & PFR SERIES)

TWO-PIECE INSERTS
(A SERIES)

TWO-PIECE INTERLOCK
FERRULES & INSERTS
(X & Z SERIES)

QUICK
RELEASE

ASSEMBLY
EQUIPMENT

TECHNICAL
INFORMATION

The electrical conductivity or non-conductivity of hose and fittings is dependant upon many factors and may be susceptible to change. These factors include but are not limited to the various materials used to make the hose and the fittings, manufacturing methods (including moisture control), how the fittings contact the hose, age and amount of deterioration of damage or others changes, moisture content of the hose at a particular time, and other factors.

2. INSTALLATION – After the selection of the correct hose, the following factors must be considered prior to hose and fitting assembly and installation:

2.1 Pre-Installation Inspection:

Prior to installation, a careful examination of the hose must be performed. All components must be checked for correct style, size, and length. The hose must be examined for cleanliness, obstructions, blisters, cover looseness, or any other visible defects.

2.2 Hose and Fitting Assembly:

Do not assemble an ALFAGOMMA fitting on an ALFAGOMMA hose that is not specified by ALFAGOMMA for that hose. Do not assemble ALFAGOMMA fittings on another manufacturer's hose or an ALFAGOMMA hose on another manufacturer's fitting unless ALFAGOMMA approves the assembly in writing, and the user verifies the assembly and the application through analysis and testing. The ALFAGOMMA published hose assembly instructions must be followed for assembling the fittings on the hose.

2.3 Related Accessories:

Crimp or swage ALFAGOMMA hose or fittings only with ALFAGOMMA approved swage or crimp machines and in accordance with the ALFAGOMMA published hose assembly instructions.

2.4 Parts:

Do not use any ALFAGOMMA hose fitting part (including but not limited to sockets, or inserts) except with the correct ALFAGOMMA mating parts, in accordance with ALFAGOMMA published hose assembly instructions, unless authorized in writing by ALFAGOMMA.

2.5 Reusable/Permanent:

Do not reuse any reusable hose coupling that has blown or pulled off a hose. Do not reuse an ALFAGOMMA permanent (that is, crimped or swaged) hose fitting or any part thereof.

2.6 Minimum Bend Radius:

Installation of a hose at less than the minimum listed bend radius may significantly reduce the hose life. Particular attention must be given to avoid sharp bending at the hose/fitting juncture.

2.7 Twist Angle and Orientation:

Hose installations must be such that relative motion of machine components does not produce twisting.

2.8 Hose Restraints:

In many applications, it may be necessary to restrain, protect, or guide the hose to protect it from damage by unnecessary flexing, pressure surges, and contact with other mechanical components. Care must be taken to ensure such restraints do not introduce additional stress or wear points.

2.9 Proper Connection of Parts:

Proper physical installation of the hose requires a correctly installed port connection while ensuring that no twist or torque is transferred to the hose.

2.10 External Damage:

Proper installation is not complete without ensuring that tensile loads, side loads, kinking, flattening, potential abrasion, thread damage, or damage to sealing surfaces are corrected or eliminated.

2.11 System Checkout:

After completing the installation all air entrapment must be eliminated and the system pressurized to the maximum system pressure and checked for proper function without any leaks. Personnel must stay out of potential hazardous areas while testing.

3. HOSE AND FITTING MAINTENANCE INSTRUCTIONS

Even with proper selection and installation, hose life may be significantly reduced without a continuing maintenance program. Frequency should be determined by the severity of the application and risk potential. A maintenance program must be established and followed to include the following as a minimum:

3.1 Visual Inspection Hose/Fitting:

Any of the following conditions require immediate shutdown and replacement of the hose assembly:

- Fitting slippage on hose.
- Damaged, cut, or abraded cover (any reinforcement exposed).
- Hard, stiff, heat cracked, or charred hose.
- Cracked, damaged, or badly corroded fittings.
- Leaks at fitting or in hose.
- Kinked, crushed, flattened, or twisted hose.
- Blistered, soft, degraded, or loose cover.

3.2 Other Visual Inspection:

The following items must be tightened, repaired or replaced as required:

- Leaking port conditions.
- Remove excess dirt build-up.
- Clamp, guards, shields.
- System fluid level, fluid type, and any air entrapment.

3.3 Functional Test:

Operate the system at maximum operating pressure and check for possible malfunctions and freedom from leaks. Personnel must stay out of potential hazardous areas while testing.

3.4 Replacement Intervals:

Specific replacement intervals must be considered based on previous service life, government or industry recommendations, or when failures could result in unacceptable downtime, damage, or injury risk.

Because we continually examine ways to improve our products, we reserve the right to alter specifications or discontinue products without prior notice.

Hydraulic Hose Sizing Nomogram

Use the nomogram below to determine Hose ID Size based on Flow (Q) and Velocity.

Conversely, it can be used to determine Velocity, based on Flow (Q) and Hose ID, or Flow (Q) based on Velocity and Hose ID.

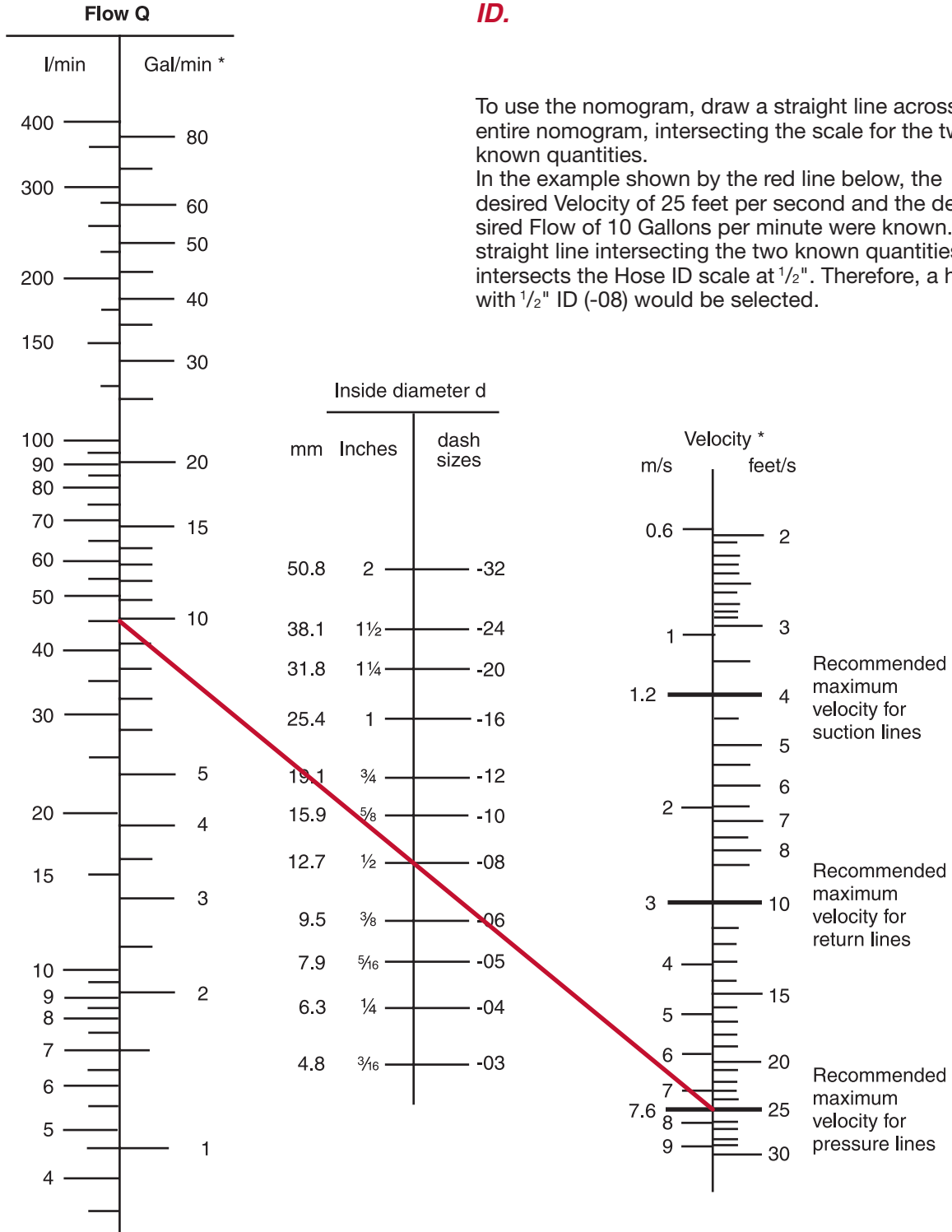

* Gallons shown are Imperial (British) Gallons. To convert to US Liquid Gallons, multiply by 1.2009.
Other Conversions: Gal/min (Brit) x 4.546 = l/min
feet/s x 0.3048 = m/s

* Recommended Velocities shown are based on hydraulic fluids with maximum viscosity of 315 SSU at 100°F (38°C) working at room temperatures within the range 65°F (18°C) and 155°F (68°C).

Because we continually examine ways to improve our products, we reserve the right to alter specifications or discontinue products without prior notice.

Pressure Drop US Chart



HOSES
ONE-PIECE B SERIES
ONE-PIECE D SERIES
ONE-PIECE F & P SERIES
TWO-PIECE FERRULES (A & PFR SERIES)
TWO-PIECE INSERTS (A SERIES)
TWO-PIECE INTERLOCK FERRULES & INSERTS (X & Z SERIES)
QUICK RELEASE
ASSEMBLY EQUIPMENT

Hose Pressure Drop*

The chart below shows pressure drop in **PSI** for 10 feet of hose (smooth bore) without fittings. Fluid specification: Specific gravity = .85; Viscosity = ν = 20 centistokes (C.S.), (20 C.S. = 97 S.S.U.); ref MIL – H 5606, +70°F (+21°C).
Flow: US gallons per minute (gpm)

Hose pressure drop in PSI per 10 feet of hose length

Hose Size	-03	-04	-05	-06	-08	-10	-12	-16	-20	-24	-32	-40	-48	
Hose I.D. (in.)	3/16	1/4	5/16	3/8	1/2	5/8	3/4	1	1-1/4	1-1/2	2	2-1/2	3	
DN	5	6	8	10	12	16	20	25	32	40	50	63	80	
US gallons per minute	.25	10	3.1											
	.50	19	6	2.7										
	1	40	12	5.5	2.4									
	2	95	24	10	4.8									
	3	185	46	17	7	2.2								
	4		78	29	12	3	1.2							
	5		120	44	18	4.5	1.6	0.7						
	8			95	39	10	3.6	1.4						
	10				59	15	5.7	2	0.6					
	12				80	20	7.2	2.6	0.8					
	15					30	10	4.2	1.2	0.4				
	18					40	15	6.3	1.5	0.6				
	20					49	19	8	2	0.7	0.3			
	25					72	26	11	3	1	0.4			
	30						34	14	3.6	1.3	0.5	0.1		
	35						47	19	5	1.7	0.7	0.2		
	40							25	6.5	2.2	0.9	0.2		
	50							36	9	3.3	1.3	0.4	0.2	
	60							50	12	4.4	1.8	0.5	0.2	
	70								17	6	2.4	0.7	0.3	
	80								21	7.1	3	0.8	0.3	0.1
	90								27	9	3.8	1	0.5	0.1
	100								33	12	4.7	1.3	0.6	0.2
	150								60	22	8.5	2.2	1	0.3
200									36	15	3.9	1.7	0.6	
250									54	22	5.3	2.5	0.8	
300										29	7.5	4	1.1	
400										51	14	6.5	2.2	
500											20	10	3	
800												18	5	
1000													10	

* Pressure drop values listed are typical of many petroleum based hydraulic oils at approximately +100°F (+38°C). Differences in fluids, fluid temperature and viscosity can increase or decrease actual pressure drop compared to the values listed.

Because we continually examine ways to improve our products, we reserve the right to alter specifications or discontinue products without prior notice.

Hose Pressure Drop*

Pressure drop in **KPa** (Kilo Pascal) for a 10 meter length of hose (smooth bore) without fittings. Fluid specification: specific gravity = 0.85; Viscosity = 20 centistokes (C.S.); ref MIL – H 5606 at +21°C (+70°F). Flow: Litres per minute (L/min)

Hose pressure drop in KPa per 10 meters of hose length

Hose size	-03	-04	-05	-06	-08	-10	-12	-16	-20	-24	-32	-40	-48
DN real	4.8	6.4	8.0	9.5	12.7	15.9	19.0	25.4	31.8	38.1	50.8	63.5	76.2
DN	5	6	8	10	12	16	20	25	32	40	50	63	80
Liters per minute	1	242	75										
	2	466	146	66									
	4	996	293	133	59								
	8	2433	613	250	117								
	10	3540	880	335	144	45							
	15		1776	660	273	69	27						
	20		3080	1129	462	116	41	18					
	30			2159	887	228	82	32					
	40				1496	379	141	50	14				
	50					555	192	75	22				
	60					756	263	111	30	10			
	70					970	373	154	37	13			
	80					1250	475	200	49	17	7		
	90					1531	560	237	66	21	9		
	100						653	274	73	24	10	3	
	125						964	393	103	36	15	4	
	150							567	147	50	19	5	
	175							735	186	60	27	7	3
	200							920	228	83	33	9	4
	250								347	124	50	13	6
300								475	162	68	17	8	3
400								832	303	118	32	14	5
500								1159	425	164	43	19	6
600									562	222	57	26	8
700									733	301	78	35	11
800									924	383	98	43	14
900									1144	468	118	53	16
1000										553	140	68	20

* Pressure drop values listed are typical of many petroleum based hydraulic oils at approximately +100°F (+38°C). Differences in fluids, fluid temperature and viscosity can increase or decrease actual pressure drop compared to the values listed.

Because we continually examine ways to improve our products, we reserve the right to alter specifications or discontinue products without prior notice.

Assembly Length

HOSES
 ONE-PIECE B SERIES
 ONE-PIECE D SERIES
 ONE-PIECE F & P SERIES
 TWO-PIECE FERRULES (A & PFR SERIES)
 TWO-PIECE INSERTS (A SERIES)
 TWO-PIECE INTERLOCK FERRULES & INSERTS (X & Z SERIES)
 QUICK RELEASE
 ASSEMBLY EQUIPMENT
 TECHNICAL INFORMATION

How to Determine Correct Assembly Length



For most assemblies, the correct assembly length may be determined by direct measurement of the equipment or a drawing. Minimum bend radii as shown in the hose specification tables should be observed.

Assemblies are measured to the end of the seal.

To determine the length of hose needed in making assemblies with permanent or reusable couplings, subtract Dimension "C" (Cut off factor) for each coupling from the required overall assembly length. Dimension "C" may be found in the coupling specification tables.

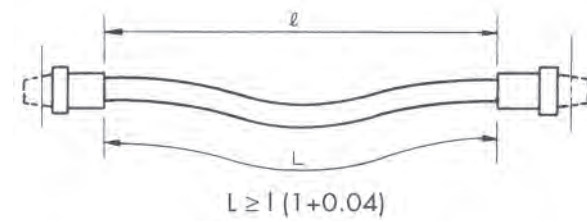
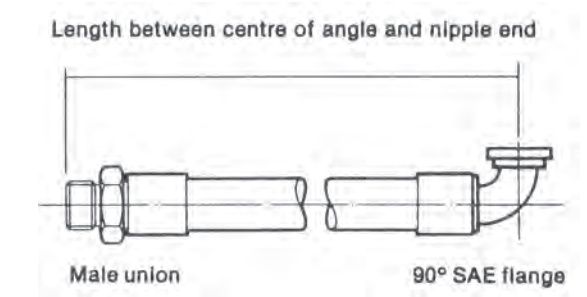
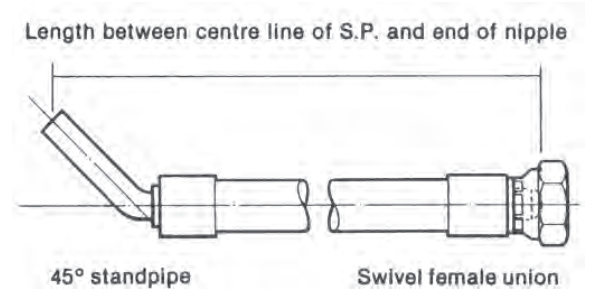
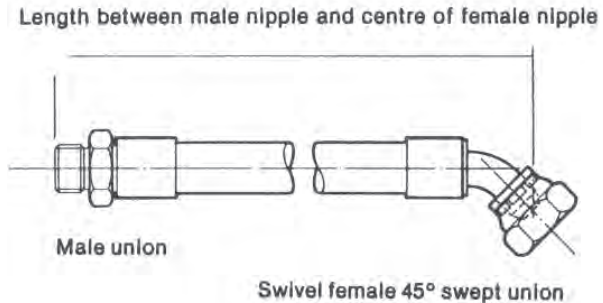
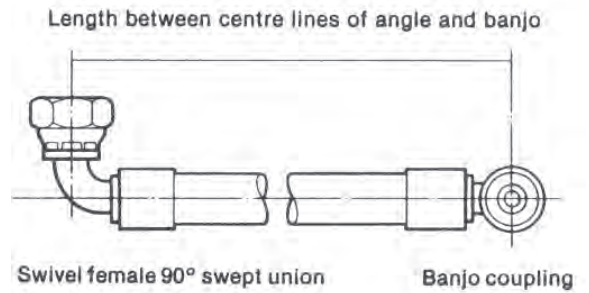
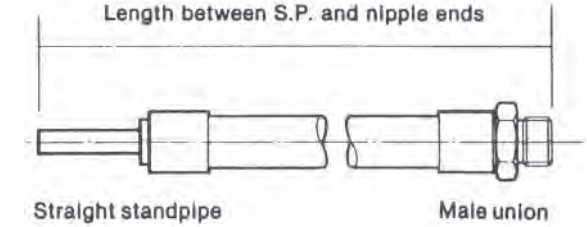
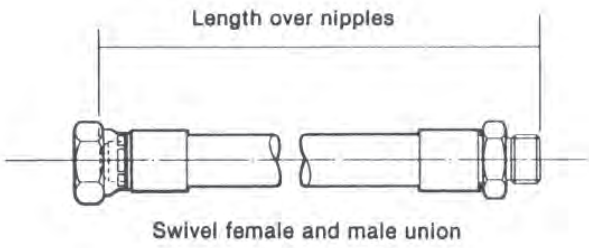

Remember that hydraulic hose under pressure will elongate up to 2% of its length or contract up to 4% depending on pressure, type and size. Sufficient allowance should be made to permit such changes in length.

Because we continually examine ways to improve our products, we reserve the right to alter specifications or discontinue products without prior notice.

Occasionally an assembly will be required similar to the sketches to the right. The following equations are helpful in determining the correct length:

FOR 180° TURN APPLICATIONS

$$\#1 L = 2A + \pi R$$

$$\#2 L = 2A + \pi R + T$$

L = Overall length of the hydraulic hose assembly, in mm or inches.

A = Allowance for a minimum straight section of hydraulic hose at each end of the assembly, measure from the outer end of each coupling, in mm or inches. These two straight sections are necessary to prevent excessive stress concentrations directly back of the couplings. See table below.

R = Bending radius of the hose, in mm or inches. See hose specifications tables.

T = Amount of travel, in mm or inches.

Often right angle adapters provide a convenient means of avoiding a bend radius that is too small.

Hose ID	in.	1/4	5/16	3/8	1/2	5/8	3/4	1	1 1/4	1 1/2	2
	mm	6.4	7.9	9.5	12.7	15.9	19	25	31.8	38.1	50.8
Min. "A"	in.	5	5	5	6	6	7	8	9	10	11
	mm	127	127	127	152	152	178	203	229	254	279

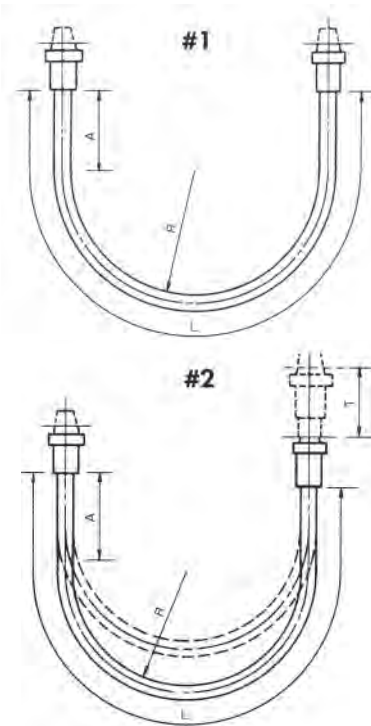

Length Tolerance for Hydraulic Hose Assemblies and Specified Hose Lengths

Length

- For lengths from 0 up to and including 12" (305 mm)
- For lengths > 12" (305 mm) < 18" (457 mm)
- For lengths > 18" (457 mm) < 36" (914 mm)
- For lengths > 36" (914 mm) < 48" (1219 mm)
- For lengths > 48" (1219 mm) < 72" (1830 mm)
- For lengths > 72" (1830 mm)

Elbow angle and angle of Orientation.

Tolerance

- ± 1/8" ± 3 mm
- ± 3/16" ± 5 mm
- ± 1/4" ± 6 mm
- ± 3/8" ± 10 mm
- ± 1/2" ± 13 mm
- ± 1%

Tolerance ± 3

Angle Couplings

A – To measure angle of offset of a hose assembly, point one end of coupling "A" (the nearest) to a vertical position downward. The angle can then be measured from the centerline of this vertical coupling "B" (the far coupling). See illustration at right.

Relationships can then be expressed from 0° to 360°. If angle is not given, elbows are positioned at 0°.

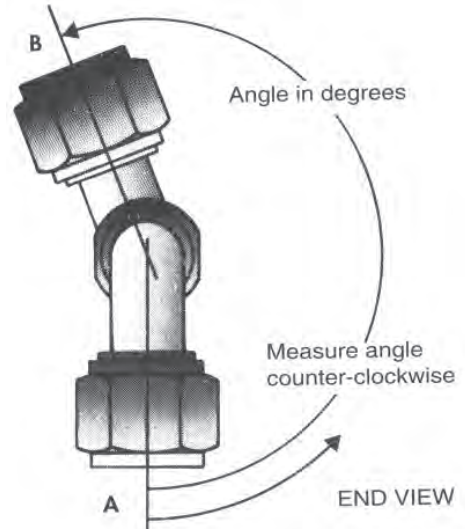

Because we continually examine ways to improve our products, we reserve the right to alter specifications or discontinue products without prior notice.

Correct Assembly & Installation

Satisfactory performance and appearance depend upon proper hose installation. Excessive length destroys the trim appearance of an installation and adds unnecessarily to the cost of the equipment. Hose assemblies of insufficient length to permit

adequate flexing, expansion or contraction will cause poor power transmission and shorten the life of the hose.

The diagrams below offer suggestions for proper hose installations to obtain the maximum in performance and economy.

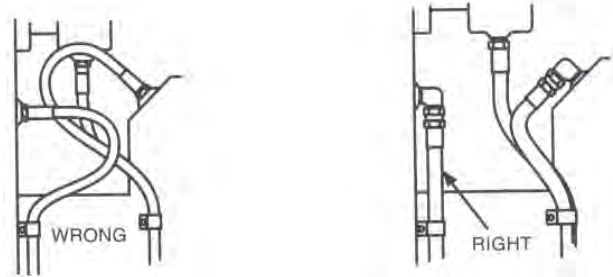
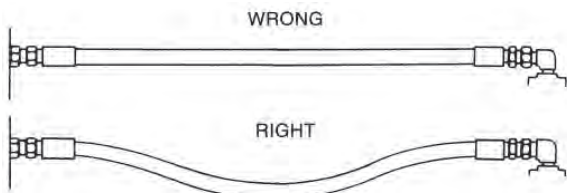

Since hose may change in length from +2% to -4% under the surge of high pressure, provide sufficient slack for expansion and contraction.

Obtain direct routing of hose through use of 45° and 90° adapters and fittings. Improve appearance by avoiding excessive hose length.

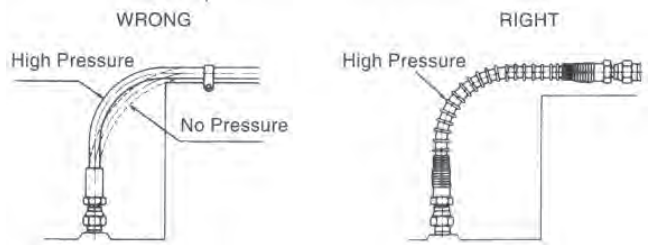
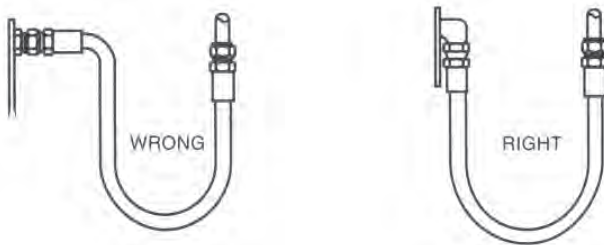

Avoid a sharp twist or bend in the hose by using the proper angle adaptors.

Due to changes in the length when a hose is pressurized, do not clamp at bends so curves absorb changes and protect the hose with a spring guard. Do not clamp high and low pressure lines together and protect the hose with a spring guard.

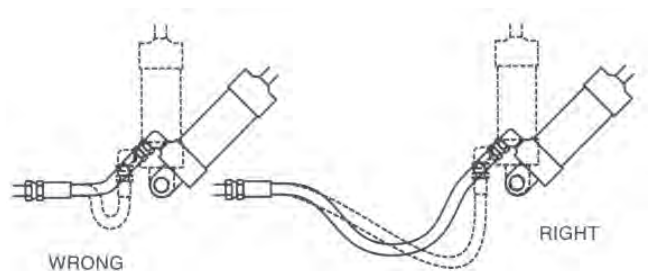
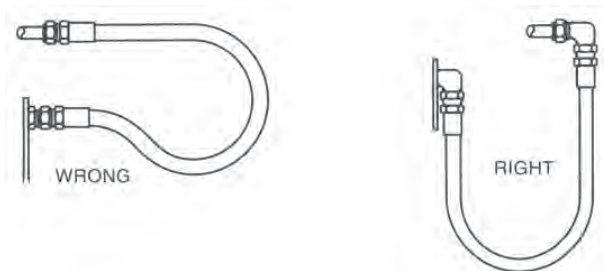

Where the radius falls below the required minimum, an angle adaptor should be used as shown above to avoid a sharp bend in the hose.

Adequate hose length is most important to distribute movement on flexing applications and to avoid abrasion.

Because we continually examine ways to improve our products, we reserve the right to alter specifications or discontinue products without prior notice.

HOSES
ONE-PIECE B SERIES
ONE-PIECE D SERIES
ONE-PIECE F & P SERIES
TWO-PIECE FERRULES (A & PFR SERIES)
TWO-PIECE INSERTS (A SERIES)
TWO-PIECE INTERLOCK FERRULES & INSERTS (X & Z SERIES)
QUICK RELEASE
ASSEMBLY EQUIPMENT
TECHNICAL INFORMATION

Correct Assembly & Installation

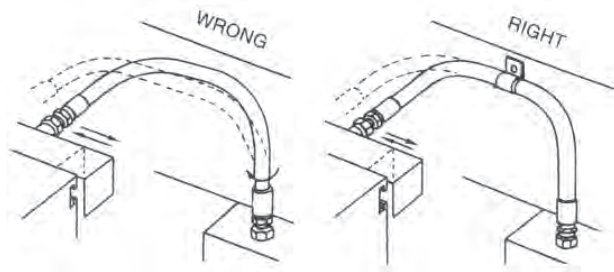

To avoid twisting in hose lines bent in two planes, clamp hose at change of plane, as shown.

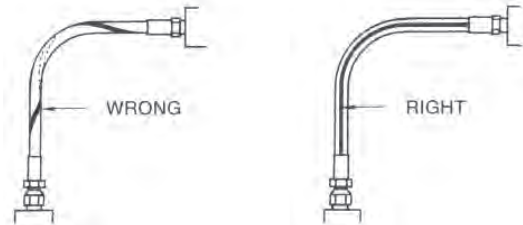

Hose should not be twisted.

Hose is weakened when installed in a twisted position. Also pressure in twisted hose tends to loosen fitting connections. Design so that machine motion produces bending rather than twisting.

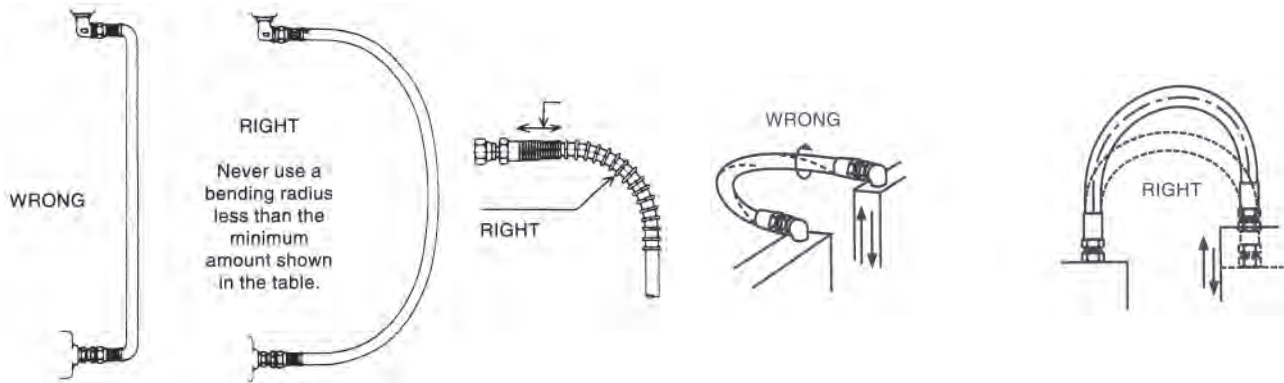

To prevent twisting and distortion, hose should be bent in the same plane as the motion of the boss to which the hose is connected.

Never use a bending radius less than the minimum shown in the hose specification tables. Avoid sharp bends in hoses to reduce collapsing of lines and restriction of flow by using a proper spring guard. Exceeding minimum bend radius will greatly reduce hose assembly life.

Because we continually examine ways to improve our products, we reserve the right to alter specifications or discontinue products without prior notice.

HOSES
ONE-PIECE B SERIES
ONE-PIECE D SERIES
ONE-PIECE F & P SERIES
TWO-PIECE FERRULES (A & PFR SERIES)
TWO-PIECE INSERTS (A SERIES)
TWO-PIECE INTERLOCK FERRULES & INSERTS (X & Z SERIES)
QUICK RELEASE
ASSEMBLY EQUIPMENT
TECHNICAL INFORMATION

Measuring Threads and Seat Angles

Measuring Threads

With the calliper, measure the thread diameter at the largest point. (O.D. of male threads – I.D. of female threads). See illustration at right.

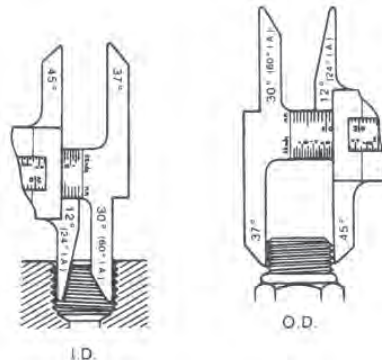

Use a thread pitch gauge (see illustration below) to determine the number of threads per inch or the distance between threads in metric connections. Place the gauge on the threads (see illustrations at right) until the fit is snug. Match the measurement to the chart.

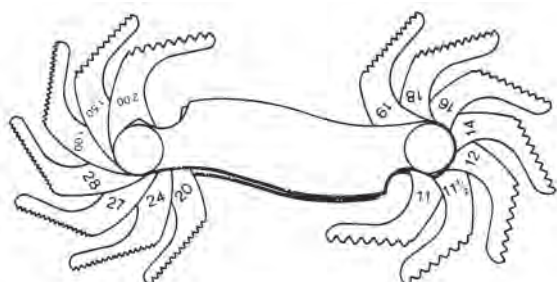

Thread Pitch Gauge

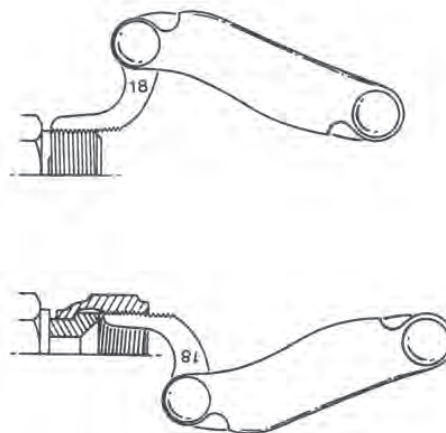

Measuring Seat Angles

When the centerline of the seat gauge extends parallel to the projected longitudinal axis of the coupling, then the angles of the gauge and seat match. See illustration at right.

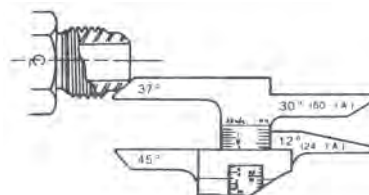

Compare the measurements taken to the couplings shown in the coupling specification tables that appear in this catalog.

Because we continually examine ways to improve our products, we reserve the right to alter specifications or discontinue products without prior notice.

HOW TO DETERMINE THE THREAD TYPE USING CALLIPERS

By measuring with a caliper the outside diameter of the thread of a male or the inside diameter of the thread of a female you will get a measure in mm. By finding this value in mm on the below table, you'll be able to find the relevant thread type.

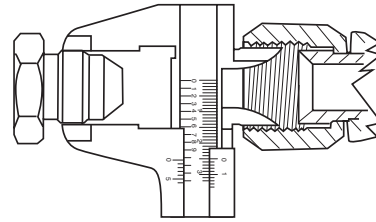

Male OD	mm	Female ID	Male OD	mm	Female ID
	8,7	G1/8" BSP		27,9	1 3/16" – 12 JIC
1/8" – 27 NPTF	9,5			28,0	M 30 x 2
G1/8" BSP	9,6			28,5	30 x 1,5 DKF
M 10 x 1	9,8		M 30 x 2	29,8	
	9,9	7/16" – 20 JIC	30 x 1,5 CEF	29,9	
	10,5	M 12 x 1,5	1 3/16" – 12 JIC	30,1	
7/16" – 20 JIC	11,0			30,7	G1" BSP
	11,4	1/2" – 20 SAE		31,2	1 5/16" – 12 JIC
	11,6	G1/4" BSP	1" – 11 1/2 NPTF	31,4	
M 12 x 1,5	11,9			31,5	M 33 x 1,5
1/4" – 18 NPTF	12,5		G1" BSP	33,1	
	12,5	M 14 x 1,5	1 5/16" – 12 JIC	33,2	
1/2" – 20 SAE	12,6			34,0	M 36 x 2
	12,9	9/16" – 18 JIC		34,5	36 x 1,5 DKF
G1/4" BSP	13,0		M 36 x 2	35,8	
M 14 x 1,5	13,9		36 x 1,5 CEF	35,9	
9/16" – 18 JIC	14,2			36,5	M 36 x 1,5
	14,5	M 16 x 1,5	M 38 x 1,5	37,9	
	15,1	G3/8" BSP		38,8	1 5/8" – 12 JIC
M 16 x 1,5	15,8			39,4	G1 1/4" BSP
3/8" – 18 NPTF	15,9			39,8	M 42 x 2
	16,5	M 18 x 1,5	1 1/4" – 11 1/2 NPTF	40,2	
G3/8" BSP	16,6			40,5	M 42 x 1,5
	17,5	3/4" – 16 JIC	1 5/8" – 12 JIC	41,1	
M 18 x 1,5	17,9		1 1/4" – 11 BSP	41,7	
	18,4	20 x 1,5 DKF	M 42 x 2	41,8	
3/4" – 16 JIC	18,8			42,4	M 45 x 2
	18,8	G1/2" BSP		43,3	45 x 1,5 DKF
1/2" – 14 NPT	19,8		M 45 x 2	44,8	
20 x 1,5 CEF	19,9		45 x 1,5 CEF	44,9	
	20,4	7/8" – 14 SAE		45,1	1 7/8" – 12 JIC
	20,5	M 22 x 1,5		45,2	G1 1/2" BSP
G1/2" BSP	20,8		1 1/2" – 11 1/2 NPTF	46,3	
	20,9	G5/8" BSP	1 7/8" – 12 JIC	47,5	
M 22 x 1,5	21,9		G1 1/2" BSP	47,7	
7/8" – 14 SAE	22,1			49,6	M 52 x 2
	22,5	24 x 1,5 DKF		50,3	52 x 1,5 DKF
G5/8" BSP	22,8		M 52 x 2	51,8	
24 x 1,5 CEF	23,9		52 x 1,5 CEF	51,9	
	24,5	G3/4" BSP		57,4	G2" BSP
	24,8	1 1/16" – 12 JIC	2" – 11 1/2 NPTF	58,3	
3/4" – 14 NPTF	25,1		G2" BSP	59,4	
	25,5	M 26 x 1,5		61,1	2 1/2" – 12 JIC
M 26 x 1,5	25,9			62,5	M 65 x 2
G3/4" BSP	26,3		2 1/2" – 12 JIC	63,3	
1 1/16" – 12 JIC	26,8				

Because we continually examine ways to improve our products, we reserve the right to alter specifications or discontinue products without prior notice.

Fitting Identification

Dash Numbers

Most fluid piping system sizes are measured by dash numbers. These are universally used abbreviations for the size of a component expressed as the numerator of the fraction with the denominator always being 16. For example, a -04 port is 4/16 or 1/4 inch. Dash numbers are usually nominal (in name only) and are abbreviations that make the ordering of components easier.

There are a few coupling systems used for hydraulic connections. They are identified as:

American, British, French, German, Japanese

This section lists the origin and coupling style. Descriptions and dimensional data follow each coupling style.

American Thread Types

NPTF – (National Pipe Tapered Fuel)

This is a dryseal thread, the National pipe tapered thread for fuels. This is used for both male and female ends. This connection is still widely used in fluid power systems, even though it is not recommended by the National Fluid Power Associations (N.F.P.A.) for use in hydraulic applications.

The NPTF male will mate with the NPTF, NPSF, or NPSM female.

The NPTF male has tapered threads and a 30° inverted seat. The NPTF female has tapered threads and no seat. The seal takes place by deformation of the threads. The NPSM female has straight threads and a 30° inverted seat. The seal takes place on the 30° seat.

The NPTF connector is similar to, but not interchangeable with, the BSPT connector. The thread pitch is different in most sizes. Also, the thread angle is 60° instead of the 55° angle found on BSPT threads.

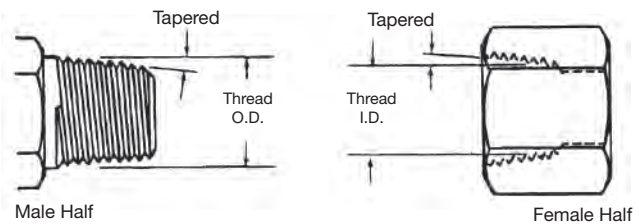

Thread Identification Table National Pipe Straight Mechanical (NPSM) National Pipe Tapered for Fuels (NPTF)

Dash Size	Inch Size (in.)	Thread Size (in - TPI)	Female Thread ID		Male Thread OD	
			(mm)	(in.)	(mm)	(in.)
-02	1/8	1/8 - 27	8.7	0.34	10.3	0.41
-04	1/4	1/4 - 18	11.9	0.47	14.3	0.56
-06	3/8	3/8 - 18	15.1	0.59	17.5	0.69
-08	1/2	1/2 - 14	18.3	0.72	21.4	0.84
-12	3/4	3/4 - 14	23.8	0.94	27.0	1.06
-16	1	1 - 11 1/2	30.2	1.19	33.3	1.31
-20	1 1/4	1 1/4 - 11 1/2	38.9	1.53	42.9	1.69
-24	1 1/2	1 1/2 - 11 1/2	44.5	1.75	48.4	1.91
-32	2	2 - 11 1/2	57.2	2.25	60.3	2.38

NPSF – (National Pipe Straight Thread for Fuels)

The National pipe straight thread for fuels. This is sometimes used for female ends and properly mates with the NPTF male end. However, the SAE recommends the NPTF thread in preference to the NPSF for female ends.

NPSM – (National Pipe Straight Mechanical)

National pipe straight thread for mechanical joint. This is used on the female swivel nut of iron pipe swivel adapters. The leak-resistant joint is not made by the sealing fit of threads, but by a tapered seat in the coupling end. This connection is sometimes used in fluid power systems.

Because we continually examine ways to improve our products, we reserve the right to alter specifications or discontinue products without prior notice.

HOSES
ONE-PIECE B SERIES
ONE-PIECE D SERIES
ONE-PIECE F & P SERIES
TWO-PIECE FERRULES (A & PFR SERIES)
TWO-PIECE INSERTS (A SERIES)
TWO-PIECE INTERLOCK FERRULES & INSERTS (X & Z SERIES)
QUICK RELEASE
ASSEMBLY EQUIPMENT
TECHNICAL INFORMATION

American

SAE J514 Straight Thread O-Ring Boss (ORB)

This port connection is recommended by the N.F.P.A. for optional leakage control in medium and high pressure hydraulic systems. The O-ring boss male will mate with an O-ring boss female only.

The female is generally found on ports.

Thread Identification Table

SAE J514 Straight Thread O-Ring Boss

Dash Size	Inch Size (in.)	Thread Size (in - TPI)	Female Thread ID		Male Thread OD	
			(mm)	(in.)	(mm)	(in.)
-02	1/8	5/16 - 24	6.9	0.27	7.8	0.31
-03	3/16	3/8 - 24	8.5	0.34	9.4	0.37
-04	1/4	7/16 - 20	9.9	0.39	11.2	0.44
-05	5/16	1/2 - 20	11.5	0.45	12.6	0.49
-06	3/8	9/16 - 18	12.9	0.51	14.1	0.56
-08	1/2	3/4 - 16	17.5	0.69	18.9	0.74
-10	5/8	7/8 - 14	20.5	0.81	22.1	0.87
-12	3/4	1 1/16 - 12	24.9	0.98	26.9	1.06
-14	7/8	1 3/16 - 12	28.1	1.11	30.0	1.18
-16	1	1 5/16 - 12	31.3	1.23	33.1	1.31
-20	1 1/4	1 5/8 - 12	39.2	1.54	41.1	1.62
-24	1 1/2	1 7/8 - 12	45.6	1.79	47.4	1.87
-32	2	2 1/2 - 12	61.4	2.42	63.3	2.49

SAE J514 37° (JIC)

The Society of Automotive Engineers (SAE) specifies a 37° angle flare or seat be used with high pressure hydraulic tubing. These are commonly called JIC couplings.

The JIC 37°Flare male will only mate with a JIC female.

The JIC male has straight threads and a 37°Flare seat.

Thread Identification Table

SAE J514 37°Flare (JIC)

Dash Size	Inch Size (in.)	Thread Size (in - TPI)	Female Thread ID		Male Thread OD	
			(mm)	(in.)	(mm)	(in.)
-02	1/8	5/16 - 24	6.9	0.27	7.8	0.31
-03	3/16	3/8 - 24	8.5	0.34	9.4	0.37
-04	1/4	7/16 - 20	9.9	0.39	11.2	0.44
-05	5/16	1/2 - 20	11.5	0.45	12.6	0.49
-06	3/8	9/16 - 18	12.9	0.51	14.1	0.56
-08	1/2	3/4 - 16	17.5	0.69	18.9	0.74
-10	5/8	7/8 - 14	20.5	0.81	22.1	0.87
-12	3/4	1 1/16 - 12	24.9	0.98	26.9	1.06
-14	7/8	1 3/16 - 12	28.1	1.11	30.0	1.18
-16	1	1 5/16 - 12	31.3	1.23	33.1	1.31
-20	1 1/4	1 5/8 - 12	39.2	1.54	41.1	1.62
-24	1 1/2	1 7/8 - 12	45.6	1.79	47.4	1.87
-32	2	2 1/2 - 12	61.4	2.42	63.3	2.49

The male has straight threads and an O-ring. The female has straight threads and a sealing face. The seal is made at the O-ring on the male and sealing face on the female.

The threads hold the connection mechanically.

SAE Straight Thread O-Ring Boss

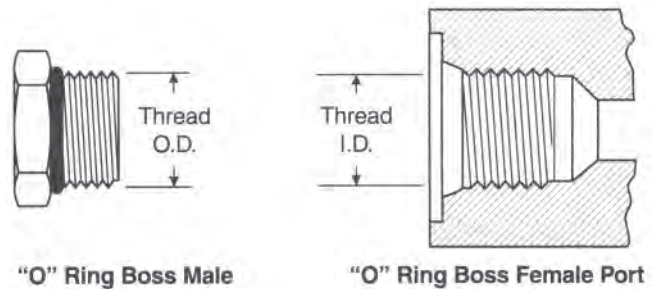

The JIC female has straight threads and a 37°Flare seat.

The seal is made on the 37°Flare seat by establishing a line contact between the male flare and the female cone seat. The threads hold the connection mechanically.

CAUTION: In the -02, -03, -04, -05, -08 and -10 sizes, the threads of the SAE 45°Flare and the SAE 37°Flare are the same. However, the sealing surface angles are not the same. Carefully measure the seat angle to differentiate.

37°Flare (JIC)

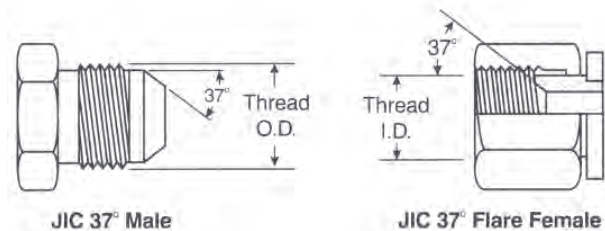

Because we continually examine ways to improve our products, we reserve the right to alter specifications or discontinue products without prior notice.

Fitting Identification - American



HOSES
ONE-PIECE B SERIES
ONE-PIECE D SERIES
ONE-PIECE F & P SERIES
TWO-PIECE FERRULES (A & PFR SERIES)
TWO-PIECE INSERTS (A SERIES)
TWO-PIECE INTERLOCK FERRULES & INSERTS (X & Z SERIES)
QUICK RELEASE
ASSEMBLY EQUIPMENT
TECHNICAL INFORMATION

American (Continued)

SAE J512 45°

A term usually applied to fittings having a 45° angle flare or seat. Soft copper tubing is generally used in such applications as it is easily flared to the 45° angle. These are for low pressure applications – commonly used in refrigeration, automotive and truck piping systems. The SAE 45°Flare male will mate with an SAE 45°Flare female only

The SAE male has straight threads and a 45°Flare seat.

The SAE female has straight threads and a 45°Flare seat.

The seal is made on the 45°Flare seat.

The threads hold the connection mechanically.

CAUTION: In the -02, -03, -04, -05, -08 and -10 sizes, the threads of the SAE 45°Flare and the SAE 37°Flare are the same. However, the sealing surface angles are not the same. Carefully measure the seat angle to differentiate.

Thread Identification Table

SAE J512 45°

Dash Size	Inch Size (in.)	Thread Size (in - TPI)	Female Thread ID		Male Thread OD	
			(mm)	(in.)	(mm)	(in.)
-02	1/8	5/16 - 24	6.9	0.27	7.9	0.31
-03	3/16	3/8 - 24	8.6	0.34	9.6	0.38
-04	1/4	7/16 - 20	9.9	0.39	11.2	0.44
-05	5/16	1/2 - 20	11.4	0.45	12.7	0.50
-06	3/8	5/8 - 18	14.2	0.56	15.7	0.62
-07	7/16	11/16 - 16	15.7	0.62	17.3	0.68
-08	1/2	3/4 - 16	17.0	0.68	19.0	0.75
-10	5/8	7/8 - 14	20.3	0.80	22.3	0.88
-12	3/4	1 1/16 - 14	25.1	0.99	26.9	1.06
-14	7/8	1 1/4 - 12	29.5	1.16	31.7	1.25
-16	1	1 3/8 - 12	32.5	1.28	35.0	1.38

SAE 45°Flare

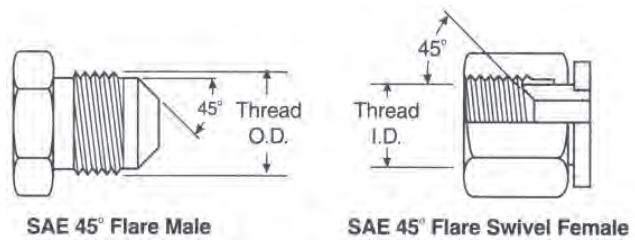

SAE J1453 O-Ring Face Seal (ORFS)

A seal is made when the O-ring in the male contacts the flat face on the female. Couplings are intended for hydraulic systems where elastomeric seals are acceptable to overcome leakage and leak resistance is crucial. This connection offers the very best leakage control available today.

The male connector has a straight thread and a machined flat face. The female has a straight thread and a machined flat face. The seal takes place by compressing the O-ring onto the flat face of the female, similar to the split flange type fitting. The threads hold the connection mechanically.

Thread Identification Table

SAE J1453 O-Ring Face Seal (ORFS)

Dash Size	Inch Size (in.)	Thread Size (in - TPI)	Female Thread ID		Male Thread OD	
			(mm)	(in.)	(mm)	(in.)
-04	1/4	9/16 - 18	12.9	0.51	14.1	0.56
-06	3/8	11/16 - 16	15.9	0.63	17.3	0.68
-08	1/2	13/16 - 16	19.1	0.75	20.5	0.81
-10	5/8	1 - 14	23.6	0.93	23.2	0.99
-12	3/4	1 3/16 - 12	28.1	1.11	30.0	1.18
-16	1	1 7/16 - 12	34.4	1.36	36.3	1.43
-20	1 1/4	1 11/16 - 12	40.8	1.61	42.7	1.68
-24	1 1/2	2 - 12	48.7	1.92	50.6	1.99

O-Ring Face Seal (ORFS)

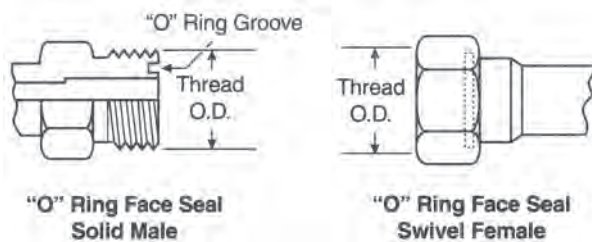

Because we continually examine ways to improve our products, we reserve the right to alter specifications or discontinue products without prior notice.



American (Continued)

SAE J512 Inverted Flare

This connection is frequently used in automotive systems. The male connector can either be a 45° Flare in the tube fitting form or a 42° seat in the machined adapter form.

The female has a straight thread with a 42° inverted flare. The seal takes place on the flared surface. The threads hold the connection mechanically.

Thread Identification Table SAE J512 Inverted Flare

Dash Size	Inch Size (in.)	Thread Size (in - TPI)	Female Thread ID		Male Thread OD	
			(mm)	(in.)	(mm)	(in.)
-02	1/8	5/16 - 28	6.9	0.27	7.9	0.31
-03	3/16	3/8 - 24	8.6	0.34	9.6	0.38
-04	1/4	7/16 - 24	9.9	0.39	11.2	0.44
-05	5/16	1/2 - 20	11.4	0.45	12.7	0.50
-06	3/8	5/8 - 18	14.2	0.56	15.7	0.62
-07	7/16	11/16 - 18	15.7	0.62	17.3	0.68
-08	1/2	3/4 - 18	17.0	0.68	19.0	0.76
-10	5/8	7/8 - 18	20.3	0.80	22.3	0.88
-12	3/4	1 1/16 - 16	25.1	0.99	26.9	1.06

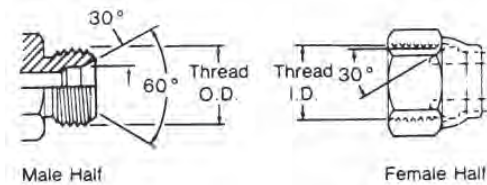

SAE J1467 Clip Fastener (Press-Lok Connector)

This is a radial O-ring seal connection commonly used for hydraulic applications in underground mines. The male contains an exterior O-ring and backup ring, plus, a groove to accept the "staple." The female has a smooth bore with two holes for the staple.

A "U" shaped staple or retaining clip is inserted through the two holes, passing through the groove in the male to lock the connection together. The seal takes place by contact between the O-ring in the male and the smooth bore of the female.

Connector Identification Table SAE J1467 Clip Fastener

Dash Size	Inch Size	Male OD		Female ID	
		(in.)	(mm)	(in.)	(mm)
-04	1/4	19/32	14.9	19/32	15.1
-06	3/8	25/32	19.9	51/64	20.1
-08	1/2	15/16	23.9	61/64	24.1
-12	3/4	1 9/64	28.9	1 9/64	29.1
-16	1	1 17/32	38.9	1 35/64	39.1
-20	1 1/4	1 13/16	45.9	1 13/16	46.1
-24	1 1/2	2 5/32	54.9	2 11/64	55.2
-32	2	2 33/64	63.9	2 17/32	64.2

Press-Lok Connectors

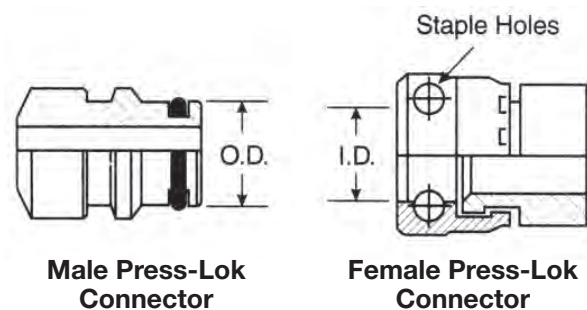

Because we continually examine ways to improve our products, we reserve the right to alter specifications or discontinue products without prior notice.

Fitting Identification - American



HOSES
ONE-PIECE B SERIES
ONE-PIECE D SERIES
ONE-PIECE F & P SERIES
TWO-PIECE FERRULES (A & PFR SERIES)
TWO-PIECE INSERTS (A SERIES)
TWO-PIECE INTERLOCK FERRULES & INSERTS (X & Z SERIES)
QUICK RELEASE
ASSEMBLY EQUIPMENT
TECHNICAL INFORMATION

American (Continued)

SAE J518/DIN20066/ISO-DIS 6162/JIS B8363 O-ring Flanges

This connection is commonly used in fluid power systems. There are two pressure ratings. Code 61 Form R, PN 35/350 bar, Type I, is referred to as the “standard” series and Code 62 Form S, PN 415 bar, Type II, is the “heavy duty” “6000 psi” series. The design concept for both series is the same, but the bolt hole spacing and flanged head diameters are larger for the higher pressure, Code 62 connection.

The female (port) is an unthreaded hole with four bolt holes in a rectangular pattern around the port.

The male consists of a flanged head, grooved for an O-ring, and either a captive flange or split flange halves with bolt holes to match the port. The seal take place on the O-ring, which is compressed between the flange head and the flat surface surrounding the port. The threaded bolts hold the connection together.

SAE J518, DIN 20066, ISO/ DIS 6162 and JIS B 8363 are interchangeable, except for bolt sizes.

SAE Code 61 and Code 62 flange 4 holes

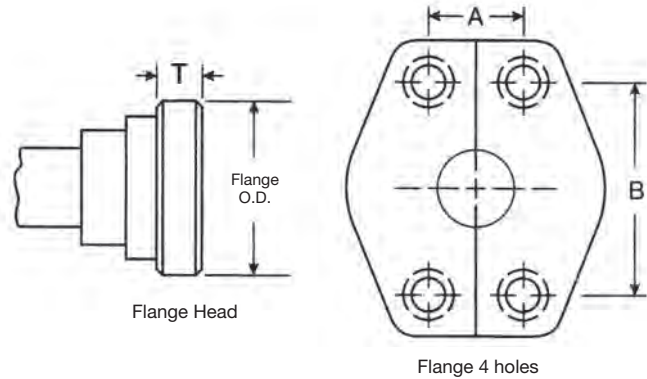

Flange Head Guide

Flange Dash Size	Code 61				Code 62				Super CAT			
	Flange Size		Flange Thickness		Flange Size		Flange Thickness		Flange Size		Flange Thickness	
	(in.)	(mm)	(in.)	(mm)	(in.)	(mm)	(in.)	(mm)	(in.)	(mm)	(in.)	(mm)
-08	1.19	30.2	.265	6.7	1.25	31.8	.305	7.7				
-10*	1.34	34.0	.265	6.7								
-12	1.50	38.1	.265	6.7	1.63	41.3	.345	8.7	1.63	41.3	.56	14.2
-16	1.75	44.5	.315	8.0	1.88	47.6	.375	9.5	1.88	47.6	.56	14.2
-20	2.00	50.8	.315	8.0	2.13	54.0	.405	10.3	2.13	54.0	.56	14.2
-24	2.38	60.3	.315	8.0	2.50	63.5	.495	12.6	2.50	63.5	.56	14.2
-32	2.81	71.4	.375	9.5	3.13	79.4	.495	12.6	3.13	79.4	.56	14.2
-40	3.31	84.1	.375	9.5								

* -10 is a non-SAE size flange.

How to Measure

Four Bolt Flange – First measure the port hole diameter using the calliper. Next, measure the longest bolt hole spacing from centre-to-centre (Dimension “A”) or measure the flanged head diameter. OD

There are three exceptions:

1. The size -10, which is common outside of North America is not an SAE Standard size.
2. Caterpillar flanges, which are the same flange OD as SAE Code 62, have a thicker flange head.
3. Poclain flanges, which are completely different from SAE flanges.

Note: All Code 61 flange head hose couplings meet or exceed SAE J518 Code 61 requirements for hydraulic split flange connections. The Code 61 flange head design can withstand a maximum operating pressure of 3000 to 5000 psi, depending on size.

Because we continually examine ways to improve our products, we reserve the right to alter specifications or discontinue products without prior notice.



British Connections

British Standard Pipe Parallel

Popular couplings British Standard Pipe (BSP) threads, also known as Whitworth threads.

The BSPP (parallel) male will mate with a BSPP (parallel) female or a female port.

The BSPP male has straight threads and a 30° seat.

The BSPP female has straight threads and a 30° seat.

The female port has straight threads and a spotface. The seal on the port is made with an O-Ring or soft metal washer on the male.

The BSPP (parallel) connector is similar to, but not interchangeable with, the NPSM connector. The thread pitch is different in most sizes, and the thread angle is 55° instead of the 60° angle found on NPSM threads. The female swivel BSPP has a tapered nose which seals on the cone seat of the male.

British Standard Pipe Parallel (BSPP)

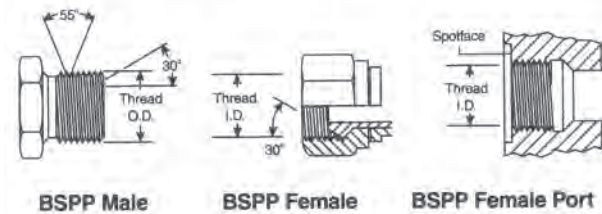

British Standard Pipe Tapered

The BSPT (tapered) male will mate with a BSPT (tapered) female, or a BSPP (parallel) female.

The BSPT male has tapered threads. When mating with either the BSPT (tapered) female or the BSPP (parallel) female port, the seal is made on the threads accomplished by thread distortion. A thread sealant is recommended.

The BSPT connector is similar to, but not interchangeable with, the NPTF connector. The thread pitch is different in most cases, and the thread angle is 55° instead of the 60° angle found on NPTF threads.

British Standard Pipe Tapered (BSPT)

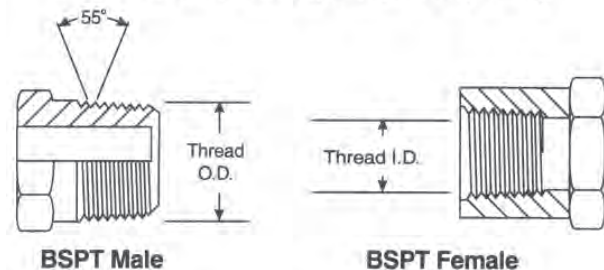

Thread Identification Table

British Standard Pipe Parallel & Tapered (BSPP & PSPT)

Dash Size	Inch Size (in.)	Thread Size (in - TPI)	Female Thread ID		Male Thread OD	
			(mm)	(in.)	(mm)	(in.)
-02	1/8	1/8 - 28	8.71	0.34	9.5	0.38
-04	1/4	1/4 - 19	11.1	0.44	13.5	0.53
-06	3/8	3/8 - 19	15.1	0.59	16.7	0.66
-08	1/2	1/2 - 14	18/3	0.72	20.6	0.81
-10	5/8	5/8 - 14	20.6	0.81	23.0	0.91
-12	3/4	3/4 - 14	23.8	0.94	26.2	1.03
-16	1	1 - 11	30.2	1.19	33.3	1.31
-20	1 1/4	1 1/4 - 11	38.9	1.53	42.1	1.66
-24	1 1/2	1 1/2 - 11	45.2	1.78	47.6	1.88
-32	2	2 - 11	56.4	2.22	59.5	2.34

Because we continually examine ways to improve our products, we reserve the right to alter specifications or discontinue products without prior notice.

Fitting Identification - French



- HOSES
- ONE-PIECE B SERIES
- ONE-PIECE D SERIES
- ONE-PIECE F & P SERIES
- TWO-PIECE FERRULES (A & PFR SERIES)
- TWO-PIECE INSERTS (A SERIES)
- TWO-PIECE INTERLOCK FERRULES & INSERTS (X & Z SERIES)
- QUICK RELEASE
- ASSEMBLY EQUIPMENT
- TECHNICAL INFORMATION

French Connections

French GAZ have a 24° seat and metric threads. These are similar to German DIN couplings, but the threads are different in some sizes, the French use fine threads in all sizes. French flanges are different than SAE, they have a lip that protrudes from the flange face. These are Poclairn style flanges.

Millimetrique and GAZ 24°

This connection consists of a common male and two different females.

The French Metric (GAZ) male will mate with the female 24° Cone or the female tube fitting.

The male has a 24° seat and straight metric threads. The female has a 24° seat or a tubing sleeve and straight metric threads. The Millimetrique Series is used with whole number metric O.D. tubing and the GAZ Series is used with fractional number metric O.D. pipe size tubing.

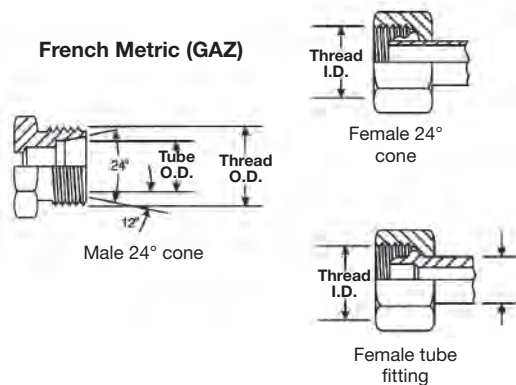

GAZ Poclairn 24° Flange

The Poclairn (French GAZ) 24° high pressure flange is usually found on Poclairn equipment.

The male flange will mate with a female flange or port. The seal is made on the 24° seat.

Thread Identification Table French Metric Millimetrique

Metric Thread (Dia. X Pitch)	Female Thread ID		Male Thread OD		Tube OD	
	(mm)	(in.)	(mm)	(in.)	(mm)	(in.)
M12 X 1.0	11.0	0.43	12.0	0.47	6	0.24
M14 X 1.5	12.5	0.49	14.0	0.55	8	0.31
M16 X 1.5	14.5	0.57	16.0	0.63	10	0.39
M18 X 1.5	16.5	0.65	18.0	0.71	12	0.47
M20 X 1.5	18.5	0.73	20.0	0.79	14	0.55
M22 X 1.5	20.5	0.81	22.0	0.87	15	0.59
M24 X 1.5	22.5	0.89	24.0	0.94	16	0.63
M27 X 1.5	25.5	1.00	27.0	1.06	18	0.71
M30 X 1.5	28.5	1.12	30.0	1.18	22	0.87
M33 X 1.5	31.5	1.24	33.0	1.30	25	0.98
M36 X 1.5	34.5	1.36	36.0	1.42	28	1.10
M39 X 1.5	37.5	1.48	39.0	1.54	30	1.18
M42 X 1.5	40.5	1.59	42.0	1.65	32	1.26
M45 X 1.5	43.5	1.71	45.0	1.77	35	1.38
M48 X 1.5	46.5	1.83	48.0	1.89	38	1.50
M52 X 1.5	50.5	1.99	52.0	2.05	40	1.57
M54 X 2.0	51.9	2.04	54.0	2.13	45	1.77

Thread Identification Table French Metric GAZ 24° Cone

Dash Size (Dash)	Inch Size (Dia. X Pitch)	Female Thread ID		Male Thread OD		Tube OD 60° Cone	
		(mm)	(in.)	(mm)	(in.)	(mm)	(in.)
-6	M20 X 1.5	18.5	0.73	20.0	0.78	13.25	0.52
-8	M24 X 1.5	22.5	0.89	24.0	0.94	16.75	0.66
-10	M30 X 1.5	28.5	1.12	30.0	1.18	21.25	0.83
-12	M36 X 1.5	34.5	1.36	36.0	1.41	26.75	1.05
-16	M45 X 1.5	43.5	1.71	45.0	1.77	33.50	1.32
-20	M52 X 1.5	50.5	1.99	52.0	2.04	42.25	1.66

Because we continually examine ways to improve our products, we reserve the right to alter specifications or discontinue products without prior notice.



German DIN Connections

A coupling referred to as metric, usually means a DIN coupling. Flanges are standard Code 61 or Code 62.

DIN 2353 24° Cone

The DIN 24° Cone male will mate with any of the three females shown below.

The male has a 24° seat, straight metric threads, and a recessed counterbore which matches the tube O.D. used with it. The mating female may be a 24° Cone with O'Ring, (DKO type) a metric tube fitting or a universal 24° or 60° Cone.

Thread Identification Table DIN 24° Cone

Metric Thread (Dia. X Pitch)	Female Thread ID		Male Thread OD		Tube OD			
	(mm)	(in.)	(mm)	(in.)	Light Series		Heavy Series	
M12 X 1.5	10.5	0.41	12	0.47	6	0.24		
M14 X 1.5	12.5	0.49	14	0.55	8	0.31	6	0.24
M16 X 1.5	14.5	0.57	16	0.63	10	0.39	8	0.31
M18 X 1.5	16.5	0.65	18	0.71	12	0.47	10	0.39
M20 X 1.5	18.5	0.73	20	0.79			12	0.47
M22 X 1.5	20.5	0.81	22	0.87	15	0.59	14	0.55
M24 X 1.5	22.5	0.89	24	0.94			16	0.63
M26 X 1.5	24.5	0.96	26	1.02	18	0.71		
M30 X 2.0	27.9	1.10	30	1.18	22	0.87	20	0.79
M36 X 2.0	33.9	1.33	36	1.42	28	1.10	25	0.98
M42 X 2.0	39.9	1.57	42	1.65			30	1.18
M45 X 2.0	42.9	1.69	45	1.77	35	1.38		
M52 X 2.0	49.9	1.96	52	2.05	42	1.65	38	1.50

DIN 3863 60° Cone

This connection is frequently used in hydraulic systems. The DIN 60° Cone male will mate with the female universal 24° or 60° Cone only.

The male has a 60° seat and straight metric threads.

Thread Identification Table DIN 60° Cone

Metric Thread (Dia. X Pitch)	Female Thread ID		Male Thread OD		Tube OD	
	(mm)	(in.)	(mm)	(in.)	(mm)	(in.)
M12 X 1.5	10.5	0.41	12	0.47	6	0.24
M14 X 1.5	12.5	0.49	14	0.55	8	0.31
M16 X 1.5	14.5	0.57	16	0.63	10	0.39
M18 X 1.5	16.5	0.65	18	0.71	12	0.47
M22 X 1.5	20.5	0.81	22	0.87	15	0.59
M26 X 1.5	24.5	0.96	26	1.02	18	0.71
M30 X 1.5	28.5	1.12	30	1.18	22	0.87
M38 X 1.5	36.5	1.44	38	1.50	28	1.10
M45 X 1.5	43.5	1.71	45	1.77	35	1.38
M52 X 1.5	50.5	1.99	52	2.05	42	1.65

There is a light and heavy series DIN coupling. Proper identification is made by measuring both the thread size and the tube O.D. (The heavy series has a smaller tube O.D. than the light, but has a thicker wall section).

DIN 24° Male and Mating Females

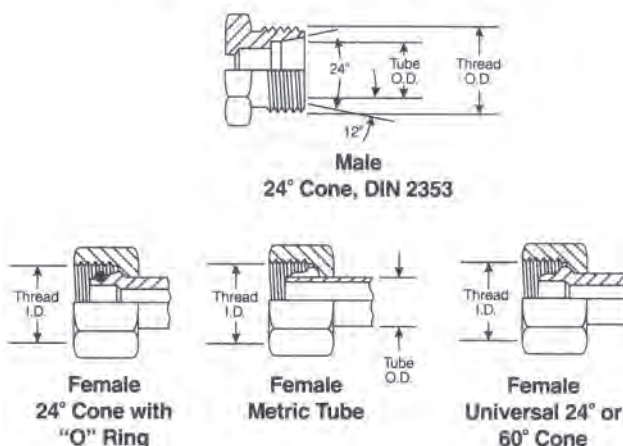

The female has a 24° and 60° universal seat and straight metric threads. The seal takes place by contact between the cone of the male and the nose of the flareless swivel. The threads hold the connection mechanically.

DIN 60° Male and Mating Female

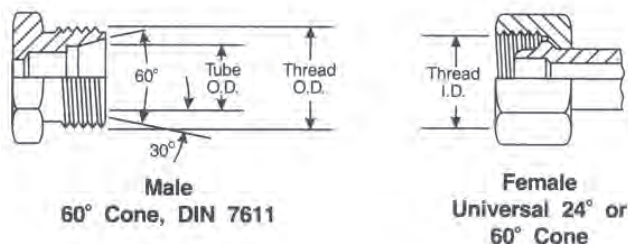

Because we continually examine ways to improve our products, we reserve the right to alter specifications or discontinue products without prior notice.

HOSES

German DIN Connections (Continued)

ONE-PIECE B SERIES

ONE-PIECE D SERIES

ONE-PIECE F & P SERIES

TWO-PIECE FERRULES (A & PFR SERIES)

TWO-PIECE INSERTS (A SERIES)

TWO-PIECE INTERLOCK FERRULES & INSERTS (X & Z SERIES)

QUICK RELEASE

ASSEMBLY EQUIPMENT

TECHNICAL INFORMATION

Metric Standpipe

A metric standpipe is comprised of three components attached to a male fitting. The components are: a Standpipe, Bite Sleeve and Metric Nut. The nut is placed over the Standpipe, followed by the Bite Sleeve (see illustration below). For DIN light assemblies, a DIN light metric nut is used. For DIN heavy assemblies, a DIN heavy metric nut is used. The Bite Sleeve and Standpipe are selected on the basis of tube O.D.

Tube O.D. (mm)	Metric Nut Thread	
	Light	Heavy
6	M12 x 1.5	
8	M14 x 1.5	M16 x 1.5
10	M16 x 1.5	M18 x 1.5
12	M18 x 1.5	M20 x 1.5
15	M22 x 1.5	
16		M24 x 1.5
18	M26 x 1.5	
20		M30 x 2.0
22	M30 x 2.0	
25		M36 x 2.0
28	M36 x 2.0	
30		M42 x 2.0
35	M45 x 2.0	
38		M52 x 2.0
42	M52 x 2.0	

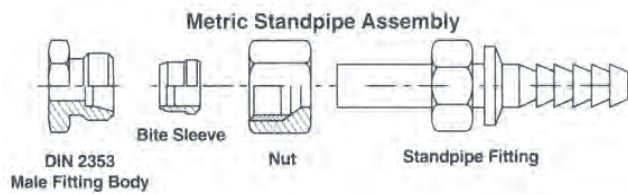

Because we continually examine ways to improve our products, we reserve the right to alter specifications or discontinue products without prior notice.

Japanese Connections

Japanese equipment uses JIS (Japanese Industrial Standard) couplings with a 30° seat and British Standard Pipe Parallel threads. All flanges are code 61 or Code 62 (except -10).

JIS 30° Flare Parallel Pipe Threads

JIS B 0202

These Japanese 30° Flare male coupling will mate with a Japanese 30° Flare female only.

The male and female have straight threads and a 30° seat. The seal is made on the 30° seat.

The threads on the Japanese 30° Flare connector conform to JIS B 020, the same as the BSPP threads. Both the British and Japanese connectors have a 30° seat, but they are not interchangeable, because the British seat is inverted.

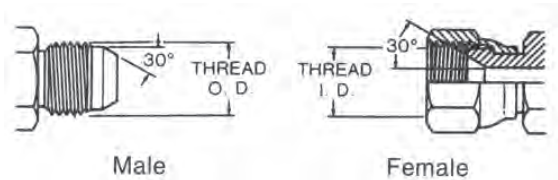

JIS 30° Inverted Seat, Parallel Pipe Threads

JIS B 0202

The JIS parallel is similar to the BSPP connection. The JIS parallel thread and the BSPP connection are interchangeable.

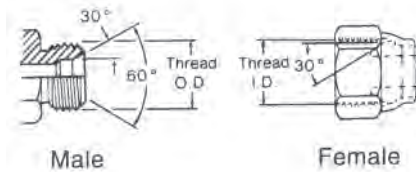

JIS Tapered Pipe Thread (PT)

JIS B 0203

The JIS tapered pipe thread connection is similar to the BSPT connection and fully interchangeable. The Japanese connection does not have a 30° Flare, and will not mate with the BSPP female. The threads conform to JIS B 0203, same as BSPT threads.

The seal on the JIS tapered pipe thread connection is made on the threads.

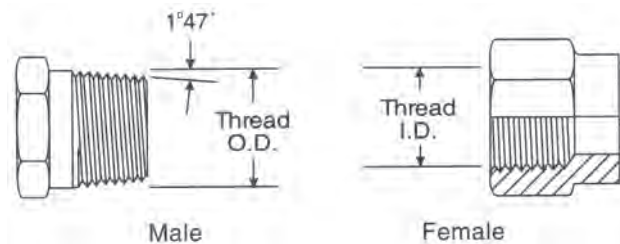

Thread Identification Table

JIS Tapered Pipe, 30° Flare Parallel Pipe, and 30° Male Inverted Seat

Dash Size	Inch Size (in.)	Thread Size (in - TPI)	Female Thread ID		Male Thread OD	
			(mm)	(in.)	(mm)	(in.)
-02	1/8	1/8 - 28	8.7	0.34	9.5	0.38
-04	1/4	1/4 - 19	11.9	0.47	13.5	0.53
-06	3/8	3/8 - 19	15.1	0.59	16.7	0.66
-08	1/2	1/2 - 14	19.1	0.75	20.6	0.81
-10	5/8	5/8 - 14	20.6	0.81	23.1	0.91
-12	3/4	3/4 - 14	23.8	0.94	26.2	1.03
-16	1	1 - 11	30.2	1.19	33.3	1.31
-20	1 1/4	1 1/4 - 11	38.9	1.53	42.1	1.66
-24	1 1/2	1 1/2 - 11	45.2	1.78	47.6	1.88
-32	2	2 - 11	56.4	2.22	59.5	2.34

Because we continually examine ways to improve our products, we reserve the right to alter specifications or discontinue products without prior notice.

Fitting Identification - Japanese



HOSES
ONE-PIECE B SERIES
ONE-PIECE D SERIES
ONE-PIECE F & P SERIES
TWO-PIECE FERRULES (A & PFR SERIES)
TWO-PIECE INSERTS (A SERIES)
TWO-PIECE INTERLOCK FERRULES & INSERTS (X & Z SERIES)
QUICK RELEASE
ASSEMBLY EQUIPMENT

Japanese Connections (Continued)

Komatsu Style 30° Flare Parallel Threads

The Komatsu style 30° Flare Parallel thread coupling is identical to the Japanese 30° Flare parallel except for the threads. The Komatsu uses Metric fine threads which conform to JIS B 0207.

The Komatsu connector seals on the 30° Flare.

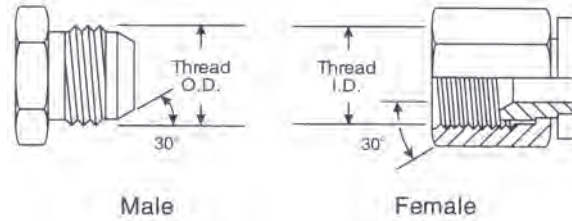

Flange Dash Size	Nominal Size		Metric Thread Size	Male Thread O. D. (mm)	B Thread I.D. (mm)
	(in.)	(mm)			
-06	3/8	9.5	M18 x 1.5	18	16.4
-08	1/2	13	M22 x 1.5	22	20.4
-10	5/8	16	M24 x 1.5	24	22.4
-12	3/4	19	M30 x 1.5	30	28.4
-16	1	25	M33 x 1.5	33	31.4
-20	1 1/4	32	M36 x 1.5	36	34.4
-24	1 1/2	38	M42 x 1.5	42	40.4

Komatsu Flange Fitting

The Komatsu Flange fitting is nearly identical to and fully interchangeable with the SAE Code 61 flange fitting. In all sizes the O-ring dimensions are different. When replacing a Komatsu flange with an SAE style flange, an SAE style O-ring must be used.

Komatsu Style Flange Fitting

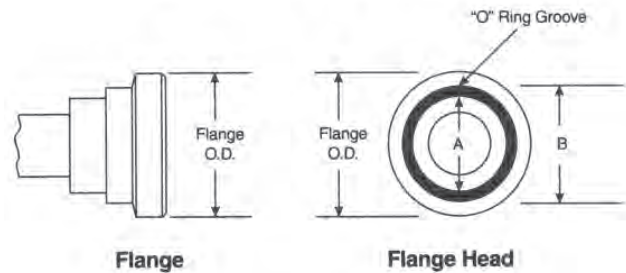

Flange Dash Size	Nominal Size		Flange Size (in.)	A (in.)	B (in.)
	(in.)	(mm)			
-08	1/2	12.7	1.19	.73	.98
-10*	5/8	15.9	1.34	.73	1.10
-12	3/4	19.1	1.50	.85	1.22
-16	1	25.4	1.75	1.12	1.50
-20	1 1/4	31.8	2.00	1.36	1.73
-24	1 1/2	38.1	2.38	1.75	2.12
-32	2	50.8	2.81	2.22	2.56

* This is a non-SAE size flange

Because we continually examine ways to improve our products, we reserve the right to alter specifications or discontinue products without prior notice.



TECHNICAL INFORMATION

Recommended Fitting and Adapter Installation Torque

Please note that the recommended values shown on this page change on a periodic basis. These are the known recommended values as set by the appropriate agency standards at the time of this catalog printing.

SAE J514 37° Flare (JIC)

Dash Size	Thread Size	lb. ft.		N. m	
		Min	Max	Min	Max
-04	7/16 - 20	11	12	15	16
-05	1/2 - 20	14	15	19	21
-06	9/16 - 18	18	20	24	28
-08	3/4 - 16	36	39	49	53
-10	7/8 - 14	57	63	77	85
-12	1 1/16 - 12	79	88	107	119
-14	1 3/16 - 12	94	103	127	140
-16	1 5/16 - 12	108	113	147	154
-20	1 5/8 - 12	127	133	172	181
-24	1 7/8 - 12	158	167	215	226
-32	2 1/2 - 12	245	258	332	350

BSPP

Dash Size	Thread Size	Torque lb. Ft.		Torque N m	
		With O-Ring	Without O-Ring	With O-Ring	Without O-Ring
-02	1/8-28	N/A	7	N/A	10
-04	1/4-19	15	15	20	20
-06	3/8-19	26	26	35	35
-08	1/2-14	37	44	50	60
-10	5/8-14	44	52	60	70
-12	3/4-14	63	85	85	115
-16	1-11	85	103	115	140
-20	1 1/4-11	140	155	190	210
-24	1 1/2-11	177	214	240	290
-32	2-11	221	295	300	400

SAE J1453 O-Ring Face Seal

Dash Size	Thread Size	lb. ft.		N. m	
		Min	Max	Min	Max
-04	9/16 - 18	10	12	14	16
-06	11/16 - 16	18	20	24	27
-08	13/16 - 16	32	35	43	47
-10	1 - 14	46	50	60	68
-12	1 3/16 - 12	65	70	90	95
-16	1 7/16 - 12	92	100	125	135
-20	1 11/16 - 12	125	140	170	190
-24	2 - 12	150	165	200	225

JIS (B8363)

Dash Size	Thread Size	lb. ft.	N.m
-04	1/4 - 19	19	25
-06	3/8 - 19	25	34
-08	1/2 - 14	49	64
-10	5/8 - 14	100	132
-12	3/4 - 14	100	132
-16	1 - 11	149	196
-20	1 1/4 - 11	171	225
-24	1 1/2 - 11	194	255
-32	2 - 11	240	316

SAE J518 Code 61 Flange Half Bolt

Dash Size	Thread Size	lb. ft.		N. m	
		Min	Max	Min	Max
-08	1/2	15	19	20	25
-12	3/4	21	29	28	40
-16	1	27	35	37	48
-20	1 1/4	35	46	48	62
-24	1 1/2	46	58	62	79
-32	2	54	66	73	90
-40	2 1/2	79	91	107	124
-48	3	137	149	186	203

Metric

Thread mm	lb. ft.	N. m
M12 x 1.5	15	15
M14 x 1.5	19	25
M16 x 1.5	33	45
M18 x 1.5	37	50
M20 x 1.5	52	70
M22 x 1.5	55	75
M24 x 1.5	74	100
M26 x 1.5	81	110
M30 x 2	96	160
M36 x 2	162	220
M42 x 2	170	230
M45 x 2	220	300
M52 x 2	367	500

SAE J518 Code 62 Flange Half Bolt

Dash Size	Thread Size	lb. ft.		N. m	
		Min	Max	Min	Max
-08	1/2	15	19	20	25
-12	3/4	25	33	34	45
-16	1	42	50	56	68
-20	1 1/4	62	75	85	102
-24	1 1/2	116	133	158	181
-32	2	199	216	271	294

Because we continually examine ways to improve our products, we reserve the right to alter specifications or discontinue products without prior notice.

HOSES

ONE-PIECE
B SERIES

ONE-PIECE
D SERIES

ONE-PIECE
F & P SERIES

TWO-PIECE FERRULES
(A & PFR SERIES)

TWO-PIECE INSERTS
(A SERIES)

TWO-PIECE INTERLOCK
FERRULES & INSERTS
(X & Z SERIES)

QUICK
RELEASE

ASSEMBLY
EQUIPMENT

TECHNICAL
INFORMATION

JIC FFFT TORQUE METHOD

The FFFT (Flats From Finger Tight) method allows to assemble fittings and adapters at the correct torque value without a dynamometric wrench. The rotation applied according the value shown in Tab.1 ensures a good sealing, avoid unscrewing and over torque that can cause nut or cone crack.

Assembling instruction:

- hand tighten the joint
- make a longitudinal mark on one of the flats of hex and continue it on the body hex as shown in Fig.1
- tighten the joint further by the number of flat as shown in Tab.1

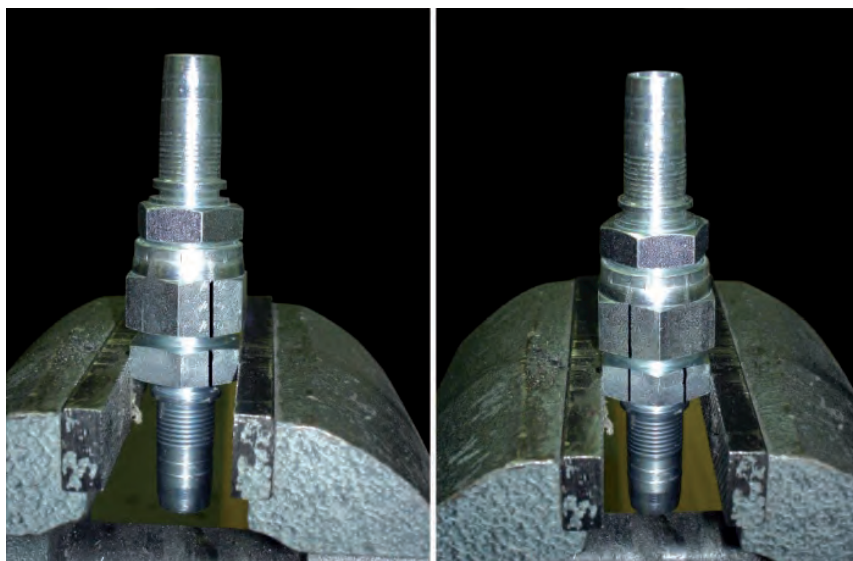

Fig.1

Assembling value - carbon steel material - SAE J514 JIC 37° flare						
Dash size	Thread	Lb*ft		N*m		FFFT 0/+0.25
		min	max	min	max	
-4	7/16-20	11	12	15	16	2
-5	1/2-20	14	15	19	21	2
-6	9/16-18	18	20	24	28	2
-8	3/4-16	36	39	49	53	1.5
-10	7/8-14	57	63	77	85	1.5
-12	1 1/16-12	79	88	107	119	1
-14	1 3/16-12	94	103	127	140	1
-16	1 5/16-12	108	113	147	154	1
-20	1 5/8-12	127	133	172	181	1
-24	1 7/8-12	158	167	215	226	1
-32	2 1/2-12	245	258	332	350	1

Tab.1

Because we continually examine ways to improve our products, we reserve the right to alter specifications or discontinue products without prior notice.

Pressure Conversion Metric to PSI (1 kPa = 0.145 PSI)

Kilo Pascals (kPa)	Mega Pascals (MPa)	Bar (Bar)	Pounds per Square Inch (PSI)
100	0.1	1	14.5
200	0.2	2	29.0
300	0.3	3	43.5
400	0.4	4	58.0
500	0.5	5	72.5
600	0.6	6	87.0
700	0.7	7	101.5
800	0.8	8	116.0
900	0.9	9	130.5
1,000	1.0	10	145.0
2,000	2.0	20	290.1
3,000	3.0	30	435.1
4,000	4.0	40	580.2
5,000	5.0	50	725.2
6,000	6.0	60	870.2
7,000	7.0	70	1,015
8,000	8.0	80	1,160
9,000	9.0	90	1,305
10,000	10	100	1,450
20,000	20	200	2,901
30,000	30	300	4,351
40,000	40	400	5,802
50,000	50	500	7,252
60,000	60	600	8,702
70,000	70	700	10,153
80,000	80	800	11,603
90,000	90	900	13,053
100,000	100	1,000	14,504
200,000	200	2,000	29,008
300,000	300	3,000	43,511

Pressure Conversion PSI to Metric (1 PSI = 6.89 kPa)

Pounds per Square Inch (PSI)	Kilo Pascals (kPa)	Mega Pascals (MPa)	Bar (Bar)
10	68.9	0.07	0.7
20	137.9	0.14	1.4
30	206.8	0.21	2.1
40	275.8	0.28	2.8
50	344.7	0.34	3.4
60	413.7	0.41	4.1
70	482.6	0.48	4.8
80	551.6	0.55	5.5
90	620.5	0.62	6.2
100	689	0.7	6.9
200	1,379	1.4	13.8
300	2,068	2.1	20.7
400	2,758	2.8	27.6
500	3,447	3.4	34.5
600	4,137	4.1	41.4
700	4,826	4.8	48.3
800	5,516	5.5	55.2
900	6,205	6.2	62.1
1,000	6,895	6.9	68.9
2,000	13,790	13.8	147.9
3,000	20,684	20.7	206.8
4,000	27,579	27.6	275.8
5,000	34,474	34.5	344.7
6,000	41,369	41.4	413.7
7,000	48,263	48.3	482.6
8,000	55,158	55.2	551.6
9,000	62,053	62.1	620.5
10,000	68,948	68.9	689.0
20,000	137,895	147.9	1,379.0
30,000	206,843	206.8	2,068.0
40,000	275,790	275.8	2,758.0

Decimal and Millimeter Equivalents of Fractions

Inches		mm	Inches		mm	Inches		mm	Inches		mm
1/64	.0156	.397	17/64	.2656	6.747	33/64	.5156	13.097	49/64	.7656	19.447
1/32	.0312	.794	9/32	.2812	7.144	17/32	.5312	13.494	25/32	.7812	19.844
3/64	.0468	1.191	19/64	.2968	7.541	35/64	.5468	13.891	51/64	.7968	20.241
1/16	.0625	1.588	5/16	.3125	7.938	9/16	.5625	14.288	13/16	.8125	20.638
5/64	.0781	2.381	21/64	.3281	8.334	37/64	.5781	14.684	53/64	.8281	21.034
3/32	.0937	2.381	11/32	.3437	8.731	19/32	.5937	15.081	27/32	.8437	21.431
7/64	.1093	2.778	23/64	.3593	9.128	39/64	.6093	15.478	55/64	.8593	21.828
1/8	.1250	3.175	3/8	.3750	9.525	5/8	.6250	15.875	7/8	.8750	22.225
9/64	.1406	3.572	25/64	.3906	9.922	41/64	.6406	16.272	57/64	.8906	22.622
5/32	.1562	3.969	13/32	.4062	10.319	21/32	.6562	16.669	29/32	.9062	23.019
11/64	.1718	4.366	27/64	.4218	10.716	43/64	.6718	17.066	59/64	.9218	23.416
3/16	.1875	4.763	7/16	.4375	11.113	11/16	.6875	17.463	15/16	.9375	23.813
13/64	.2031	5.159	29/64	.4531	11.509	45/64	.7031	17.859	61/64	.9531	24.209
7/32	.2187	5.556	15/32	.4687	11.906	23/32	.7187	18.256	31/32	.9687	24.606
15/64	.2343	5.963	31/64	.4843	12.303	47/64	.7343	18.653	63/64	.9843	25.003
1/4	.2500	6.350	1/2	.5000	12.700	3/4	.7500	19.050	1	1.0000	25.400

Because we continually examine ways to improve our products, we reserve the right to alter specifications or discontinue products without prior notice.

Temperature Conversions



HOSES

ONE-PIECE B SERIES

ONE-PIECE D SERIES

ONE-PIECE F & P SERIES

TWO-PIECE FERRULES (A & PFR SERIES)

TWO-PIECE INSERTS (A SERIES)

TWO-PIECE INTERLOCK FERRULES & INSERTS (X & Z SERIES)

QUICK RELEASE

ASSEMBLY EQUIPMENT

TECHNICAL INFORMATION

Temperature Conversion Tables

-459 to 0			0 to 100						100 to 1,000					
°C	°C °F	°F	°C	°C °F	°F	°C	°C °F	°F	°C	°C °F	°F	°C	°C °F	°F
-273	-459.4		-17.8	0	32.0	10.0	50	122.0	38	100	212	260	500	932
-268	-450		-17.2	1	33.8	10.6	51	123.8	43	110	230	266	510	950
-262	-440		-16.7	2	35.6	11.1	52	125.6	49	120	248	271	520	968
-257	-430		-16.1	3	37.4	11.7	53	127.4	54	130	266	277	530	986
-251	-420		-15.6	4	39.2	12.2	54	129.2	60	140	284	282	540	1004
-246	-410		-15.0	5	41.0	12.8	55	131.0	66	150	302	288	550	1022
-240	-400		-14.4	6	42.8	13.3	56	132.8	71	160	320	293	560	1040
-234	-390		-13.9	7	44.6	13.9	57	134.6	77	170	338	299	570	1058
-229	-380		-13.3	8	46.4	14.4	58	136.4	82	180	356	304	580	1076
-223	-370		-12.8	9	48.2	15.0	59	138.2	88	190	374	310	590	1094
-218	-360		-12.2	10	50.0	15.6	60	140.0	93	200	392	316	600	1112
-212	-350		-11.7	11	51.8	16.1	61	141.8	99	210	410	321	610	1130
-207	-340		-11.1	12	53.6	16.7	62	143.6	100	212	413	327	620	1148
-201	-330		-10.6	13	55.4	17.2	63	145.4	104	220	428	332	630	1166
-196	-320		-10.0	14	57.2	17.8	64	147.2	110	230	446	338	640	1184
-190	-310		-9.4	15	59.0	18.3	65	149.0	116	240	464	343	650	1202
-184	-300		-8.9	16	60.8	18.9	66	150.8	121	250	482	349	660	1220
-179	-290		-8.3	17	62.6	19.4	67	152.6	127	260	500	354	670	1238
-173	-280		-7.8	18	64.4	20.0	68	154.4	132	270	518	360	680	1255
-169	-273	-459	-7.2	19	66.2	20.6	69	156.2	138	280	536	366	690	1274
-168	-270	-454	-6.7	20	68.0	21.1	70	158.0	143	290	554	371	700	1292
-162	-260	-436	-6.1	21	69.8	21.7	71	159.8	149	300	572	377	710	1310
-157	-250	-418	-5.6	22	71.6	22.2	72	161.6	154	310	590	382	720	1328
-151	-240	-400	-5.0	23	73.4	22.8	73	163.4	160	320	608	388	730	1346
-146	-230	-382	-4.4	24	75.2	23.3	74	165.2	166	330	626	393	740	1364
-140	-220	-364	-3.9	25	77.0	23.9	75	167.0	171	340	644	399	750	1382
-134	-210	-346	-3.3	26	78.8	24.4	76	168.8	177	350	662	404	760	1400
-129	-200	-328	-2.8	27	80.6	25.0	77	170.6	182	360	680	410	770	1418
-123	-190	-310	-2.2	28	82.4	25.6	78	172.4	188	370	698	416	780	1436
-118	-180	-292	-1.7	29	84.2	26.1	79	174.2	193	380	716	421	790	1454
-112	-170	-274	-1.1	30	86.0	26.7	80	176.0	199	390	734	427	800	1472
-107	-160	-256	-0.6	31	87.8	27.2	81	177.8	204	400	752	432	810	1490
-101	-150	-238	0	32	89.6	27.8	82	179.6	210	410	770	438	820	1508
-96	-140	-220	0.6	33	91.4	28.3	83	181.4	216	420	788	443	830	1526
-90	-130	-202	1.1	34	93.2	28.9	84	183.2	221	430	806	449	840	1544
-84	-120	-184	1.7	35	95.0	29.4	85	185.0	227	440	824	454	850	1562
-79	-110	-166	2.2	36	96.8	30.0	86	186.8	232	450	842	460	860	1580
-73	-100	-148	2.8	37	98.6	30.6	87	188.6	238	460	860	466	870	1598
-68	-90	-130	3.3	38	100.4	31.1	88	190.4	243	470	878	471	880	1616
-62	-80	-112	3.9	39	102.2	31.7	89	192.2	249	480	896	477	890	1634
-57	-70	-94	4.4	40	104.0	32.2	90	194.0	254	490	914	482	900	1652
-51	-60	-76	5.0	41	105.8	32.8	91	195.8				488	910	1670
-46	-50	-58	5.6	42	107.6	33.3	92	197.6				493	920	1688
-40	-40	-40	6.1	43	109.4	33.9	93	199.4				499	930	1706
-34	-30	-22	6.7	44	111.2	34.4	94	201.2				504	940	1724
-29	-20	-4	7.2	45	113.0	35.0	95	203.0				510	950	1742
-23	-10	14	7.8	46	114.8	35.6	96	204.8				516	960	1760
-17.8	0	32	8.3	47	116.6	36.1	97	206.6				521	970	1778
			8.9	48	118.4	36.7	98	208.4				527	980	1795
			9.4	49	120.2	37.2	99	210.2				532	990	1814
						37.8	100	212.0				538	1000	1832

Look up the reading in the middle (shaded) column. To determine equivalent in Fahrenheit, look in right hand column; to determine equivalent in Centigrade, look in left hand column. Example: -20°F = -29°C (left).

Because we continually examine ways to improve our products, we reserve the right to alter specifications or discontinue products without prior notice.



Hexagon Across Corner Dimensions

The across corner dimensions are calculated using the factor 1.1547. Should the corners be rounded, the across corner dimensions will be smaller than shown in the table below.

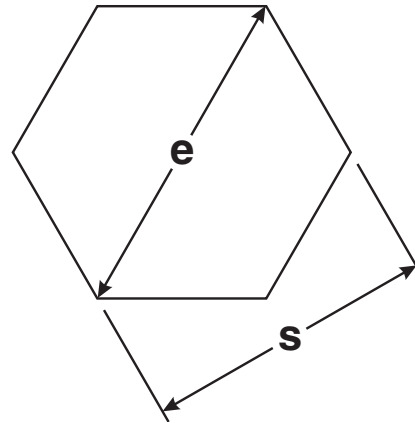

Metric Hex Sizes		Inch Hex Sizes											
		Hexagons in inches and mm; Across corner dimensions in mm											
s	e	s			e	s			e	s			e
mm	mm	ln	ln	mm	mm	ln	ln	mm	mm	ln	ln	mm	mm
10	11.5	1/4	0.25	6.4	7.4	1 1/4	1.25	31.8	36.7	2 5/16	2.31	58.7	67.8
12	13.8	9/32	0.28	7.1	8.2	1 9/32	1.28	32.5	37.5	2 3/8	2.38	60.3	69.6
14	16.2	5/16	0.31	7.9	9.1	1 5/16	1.31	33.3	38.5	2 7/16	2.44	61.9	71.5
17	19.6	11/32	0.34	8.7	10.0	1 11/32	1.34	34.1	39.4	2 1/2	2.50	63.5	73.3
19	21.9	3/8	0.38	9.2	10.6	1 3/8	1.38	34.9	40.3	2 9/16	2.56	65.1	75.2
22	25.4	13/32	0.41	10.3	11.9	1 13/32	1.41	35.7	41.2	2 5/8	2.63	66.7	77.0
24	27.7	7/16	0.44	11.1	12.8	1 7/16	1.44	36.5	42.1	2 11/16	2.69	68.3	78.9
27	31.2	15/32	0.47	11.9	13.7	1 15/32	1.47	37.3	43.1	2 3/4	2.75	69.9	80.7
30	34.6	1/2	0.50	12.7	14.7	1 1/2	1.50	38.1	44.0	2 13/16	2.81	71.4	82.4
32	36.9	17/32	0.53	13.5	15.6	1 17/32	1.53	38.9	44.9	2 7/8	2.88	73.0	84.3
36	41.6	9/16	0.56	14.3	16.5	1 9/16	1.56	39.7	45.8	2 15/16	2.94	74.6	86.1
41	47.3	19/32	0.59	15.1	17.4	1 19/32	1.59	40.5	46.8	3	3.00	76.2	88.0
46	53.1	5/8	0.63	15.9	18.4	1 5/8	1.63	41.3	47.7	3 1/16	3.06	77.8	89.8
50	57.7	21/32	0.66	16.7	19.3	1 21/32	1.66	42.1	48.6	3 1/8	3.13	79.4	91.7
55	63.5	11/16	0.69	17.5	20.2	1 11/16	1.69	42.9	49.5	3 3/16	3.19	81.0	93.5
60	69.3	23/32	0.72	18.3	21.1	1 23/32	1.72	43.7	50.5	3 1/4	3.25	82.6	95.4
65	75.0	3/4	0.75	19.1	22.0	1 3/4	1.75	44.5	51.4	3 5/16	3.31	84.1	97.1
70	80.0	25/32	0.78	19.8	22.9	1 25/32	1.78	45.2	52.2	3 3/8	3.38	85.7	99.0
75	86.5	13/16	0.81	20.6	23.8	1 13/16	1.81	46.0	53.1	3 7/16	3.44	87.3	100.8
80	92.4	27/32	0.84	21.4	24.7	1 27/32	1.84	46.8	54.0	3 1/2	3.50	88.9	102.7
85	98.0	7/8	0.88	22.2	25.6	1 7/8	1.88	47.6	55.0	3 9/16	3.56	90.5	104.5
90	104	29/32	0.91	23.0	26.6	1 29/32	1.91	48.4	55.9	3 5/8	3.63	92.1	106.3
95	110	15/16	0.94	23.8	27.5	1 15/16	1.94	49.2	56.8	3 11/16	3.69	93.7	108.2
100	116	31/32	0.97	24.6	28.4	1 31/32	1.97	50.0	57.7	3 3/4	3.75	95.3	110.0
105	121	1	1.00	25.4	29.3	2	2.00	50.8	58.7	3 13/16	3.81	96.8	111.8
110	127	1 1/32	1.03	26.2	30.3	2 1/32	2.03	51.6	59.6	3 7/8	3.88	98.4	113.6
115	133	1 1/16	1.06	27.0	31.2	2 1/16	2.06	52.4	60.5	3 15/16	3.94	100.0	115.5
120	139	1 3/32	1.09	27.8	32.1	2 3/32	2.09	53.2	61.4	4	4.00	101.6	117.3
130	150	1 1/8	1.13	28.6	33.0	2 1/8	2.13	54.0	62.4	4 1/8	4.13	104.8	121.0
135	156	1 5/32	1.16	29.4	33.9	2 5/32	2.16	54.8	63.3	4 1/4	4.25	108.0	124.7
145	167	1 3/16	1.19	30.2	34.9	2 3/16	2.19	55.6	64.2	4 3/8	4.38	111.1	128.3
150	173	1 7/32	1.22	31.0	35.8	2 1/4	2.25	57.5	66.0	4 1/2	4.50	114.3	132.0

Because we continually examine ways to improve our products, we reserve the right to alter specifications or discontinue products without prior notice.

Notes

HOSES

ONE-PIECE B SERIES

ONE-PIECE D SERIES

ONE-PIECE F & P SERIES

TWO-PIECE FERRULES (A & PFR SERIES)

TWO-PIECE INSERTS (A SERIES)

TWO-PIECE INTERLOCK FERRULES & INSERTS (X & Z SERIES)

QUICK RELEASE

ASSEMBLY EQUIPMENT

TECHNICAL INFORMATION

Because we continually examine ways to improve our products, we reserve the right to alter specifications or discontinue products without prior notice.



Cautionary Statement

All Products sold and distributed by Kuriyama of America, Inc. are commodities and are sold based on their ability to perform within each product's published specifications. The Products are not sold for particular purposes, uses or applications. Purchasers and users are solely responsible for determining whether the Products are suitable for the purchaser's or user's intended purposes, uses or applications. Purchasers and users shall conduct their own engineering studies or tests, or retain qualified engineers, consultants or testing laboratories before determining the proper use, suitability or propriety of the Products. Alfagomma and Piranha Hose hoses and fittings are designed, engineered and tested to be used together in an assembly. Alfagomma and Piranha Hose do not recommend or authorize the use of their hoses or fittings with another manufacturer's hoses or fittings, as doing so may result in unreliable or unsafe assemblies.

Purchasers and users should follow all instructions contained in the catalogs, brochures, technical bulletins and other documents of Kuriyama of America, Alfagomma and Piranha Hose. Kuriyama of America, Alfagomma and Piranha Hose recommend only those hose and coupling combinations specified in the applicable Hydraulic Products Catalogs. The Products, including but not limited to, hose, tubing or couplings, may fail due to the use or conveyance of substances at elevated or lowered temperatures or at excessive pressure, the conveyance of abrasive, injurious, flammable, explosive or damaging substances.

Hose or tubing used in bent configurations will be subjected to increased abrasion. Hose clamps or couplings may loosen after initial installation, and all sections of hose and tubing – including connections, couplings, clamps, conductivity and bonding – should be inspected frequently, regularly and consistently, and should be replaced, adjusted or re-tightened to avoid leakage, prevent injuries or damage, and for general safety purposes.

Purchasers or users of the Products should frequently and consistently undertake inspections and protective measures with respect to the use and application of Products, which should include the examination of tube and cover, conditions of the hose or tubing, and the identification, repair or replacement of sections showing cracking, blistering, separations, internal and external abrasions, leaking or slipped couplings or connections and make proper proof tests.

Kuriyama of America, Alfagomma and Piranha Hose shall not be liable or responsible for hose assemblies that have not been produced in conformance with their assembly recommendations and current crimp data charts.

Limited Warranty and Limitation of Liability

The Products sold or distributed by Kuriyama of America are warranted to its customers to be free from defects in material and workmanship at the time of shipment by us, subject to the following provisions. ALL WARRANTY CLAIMS SHALL BE MADE WITHIN SIX (6) MONTHS AFTER KURIYAMA OF AMERICA SHIPPED THE PRODUCTS. KURIYAMA OF AMERICA'S LIABILITY HEREUNDER IS LIMITED, AT KURIYAMA OF AMERICA'S EXCLUSIVE DISCRETION, TO 1) REFUND OF THE PURCHASE PRICE PAID TO IT FOR DEFECTIVE PRODUCTS; OR 2) REPLACEMENT OF ANY DEFECTIVE PRODUCT OR PART UPON ITS AUTHORIZED RETURN TO KURIYAMA OF AMERICA.

THIS LIMITED WARRANTY IS IN LIEU OF AND EXCLUDES ALL OTHER WARRANTIES, EXPRESSED, IMPLIED, STATUTORY, OR OTHERWISE CREATED UNDER APPLICABLE LAW INCLUDING, BUT NOT LIMITED TO, ANY WARRANTY OF MERCHANTABILITY AND ANY WARRANTY OF FITNESS FOR A PARTICULAR PURPOSE. IN NO EVENT SHALL KURIYAMA OF AMERICA, ALFAGOMMA OR PIRANHA HOSE BE LIABLE FOR SPECIAL, INCIDENTAL, OR CONSEQUENTIAL DAMAGES, INCLUDING LOSS OF PROFITS, WHETHER OR NOT CAUSED BY OR RESULTING FROM THE NEGLIGENCE OF KURIYAMA OF AMERICA, ALFAGOMMA OR PIRANHA HOSE.

IN ADDITION, THIS WARRANTY SHALL NOT APPLY TO ANY PRODUCTS OR PORTIONS THEREOF WHICH HAVE BEEN SUBJECTED TO ABUSE, MISUSE, IMPROPER INSTALLATION, MAINTENANCE, OR OPERATION, ELECTRICAL FAILURE OR ABNORMAL CONDITIONS, AND TO PRODUCTS WHICH HAVE BEEN TAMPERED WITH, ALTERED, MODIFIED, REPAIRED, REWORKED BY ANYONE NOT APPROVED BY SELLER, OR USED IN ANY MANNER INCONSISTENT WITH THE PROVISIONS OF THE "CAUTIONARY STATEMENT" ABOVE OR ANY INSTRUCTIONS, MATERIALS OR SPECIFICATIONS PROVIDED WITH OR FOR THE PRODUCT.

Because we continually examine ways to improve our products, we reserve the right to alter specifications or discontinue products without prior notice.



HOSES

ONE-PIECE
B SERIES

ONE-PIECE
D SERIES

ONE-PIECE
F & P SERIES

TWO-PIECE FERRULES
(A & PFR SERIES)

TWO-PIECE INSERTS
(A SERIES)

TWO-PIECE INTERLOCK
FERRULES & INSERTS
(X & Z SERIES)

QUICK
RELEASE

ASSEMBLY
EQUIPMENT

TECHNICAL
INFORMATION



Kuriyama of America – HQ



Kuriyama of America – Houston



Kuriyama of America – Santa Fe Springs



Fortney Sales Co.



Eastern Rubber & Plastics Co.



Kuriyama De México

Distributed by:



Kuriyama of America, Inc.

Headquarters, Sales Office and Warehouse Location
360 E. State Parkway, Schaumburg, IL 60173-5335
Phone: (847) 755-0360 • Toll-free FAX: (800) 800-0320
International FAX: (847) 885-0996

Web Site: www.kuriyama.com
E-Mail: sales@kuriyama.com



CONTACT OUR SALES/WAREHOUSE LOCATIONS BELOW WHICH SERVE YOUR AREA

SOUTHWEST WAREHOUSE KURIYAMA OF AMERICA, INC. HOUSTON

200 PORTWALL STREET, SUITE 100
HOUSTON, TX 77029
Phone: (713) 674-8212
Toll Free Phone: (800) 501-6808
FAX: (713) 674-5214
Toll Free FAX: (800) 800-5214

WESTERN WAREHOUSE KURIYAMA OF AMERICA, INC. SANTA FE SPRINGS

10749 SHOEMAKER AVENUE
SANTA FE SPRINGS, CA 90670-4039
Phone: (562) 941-4507
FAX: (562) 941-8940
Toll-Free FAX: (800) 326-8940

SOUTHEAST WAREHOUSE FORTNEY SALES CO., INC.

4221 CANTRELL ROAD NW
ACWORTH, GA 30101
PHONE: (770) 427-6528
FAX: (770) 423-9249
Toll Free FAX: (800) 423-9249
Web Site: www.fortneysales.com
E-Mail: sales@fortneysales.com

EASTERN WAREHOUSE EASTERN RUBBER & PLASTICS CO., INC.

100 GOLDMAN DR.
PLUMSTED INDUSTRIAL PARK
CREAM RIDGE, NJ 08514
Phone: (609) 758-0100
FAX: (609) 758-0102
Toll Free FAX: (800) 445-7138
Web Site: www.easternrubber.com
E-Mail: sales@easternrubber.com

IN MEXICO:

KURIYAMA DE MÉXICO S DE RL DE CV AV JOSE PALOMO MARTINEZ NO 520-20 BODEGA 5

PARQUE INDUSTRIAL OMOLAP
APODACA, N.L. CP:66633, MÉXICO
Phone: (81) 1086-1870 O 71
Toll-Free: (within Mexico) 01-800-822-52-00
FAX: (81) 1086-1869

Internet: www.kuriyama.com.mx
www.kuriyama.com
Correo Electronico: ventas@kuriyama.com

Visit us
www.kuriyama.com
on the Web!